



Orthopedics

Orthopedics

1

Knee

2

Shoulder

3

Hip

4

Elbow / Foot

5

Hand / Fingers / Toes

6

FLUID MANAGEMENT Suction and Irrigation Pumps

7

Universal Motor Systems

8

Battery-powered tools bee-system II

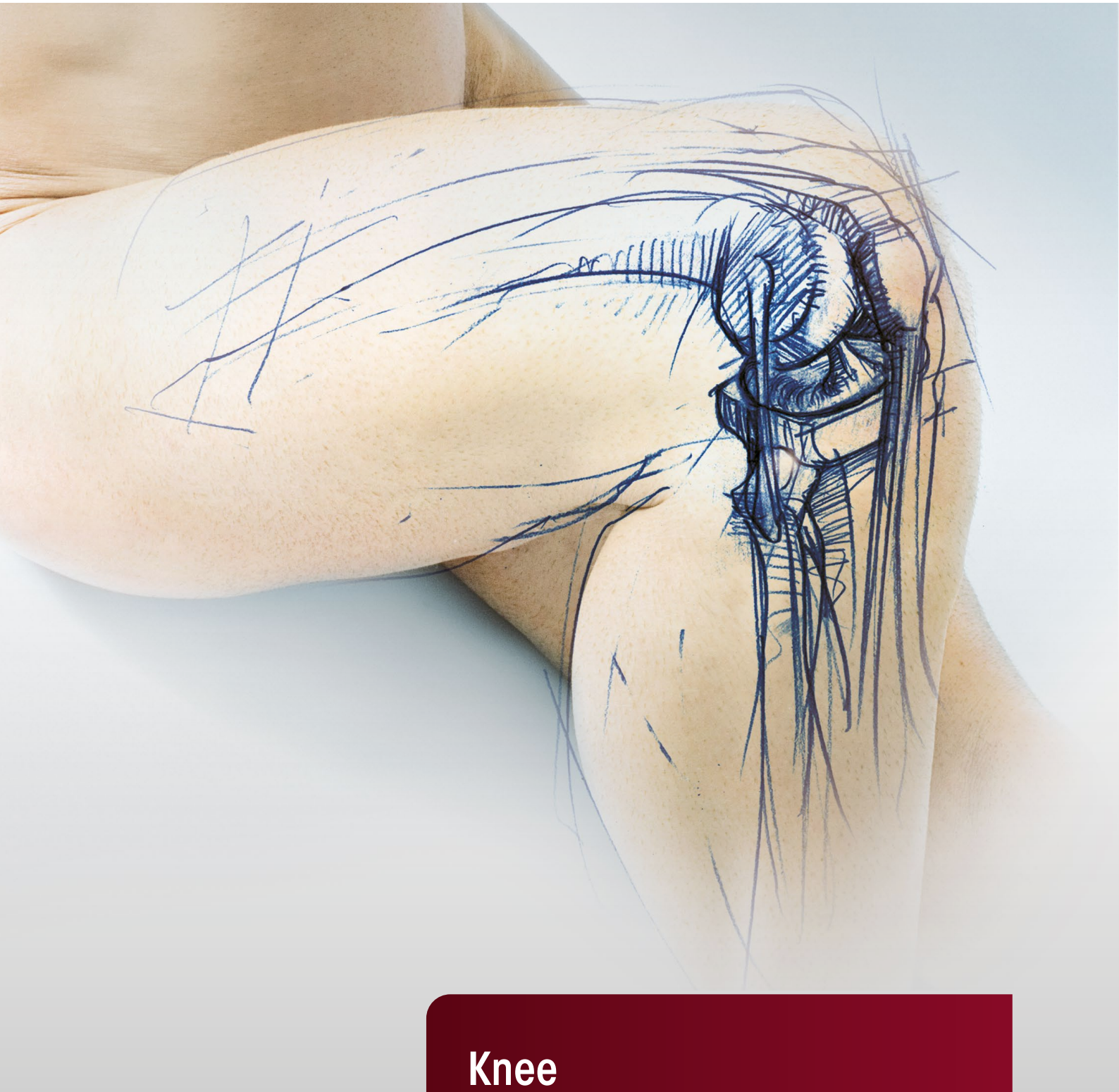

Knee

Knee

1.1

Standard Equipment

1.2

Meniscal and Soft Tissue Resection / Extraction

1.3

Meniscus Refixation

1.4

Treatment of Cartilage Defects

1.5

Cruciate Ligament Reconstruction

1.6

Leg Holders

Basic Equipment

for diagnostic and operative arthroscopy

Product	Product no.	Quantity	Catalog / Section
Endoscopes and Instruments			
PANOVIEW telescope 30° Ø 4mm SL 170mm	8880.543	1	Orthopedics / Knee
Sheath for arthroscope OD 6mm	89121.1260	1	
Obturator for arthroscope OD 5.5/6/6.3mm	89121.0542	1	
Fiber light cable bndl, Ø 3.5 mm, 2.3 m long	806635231	1	
Hook probe WL 115mm H 4.5mm	8399.95	1	
ARTHROline punch W 4.6mm H 1.6mm, straight sheath	89140.0102	1	
ARTHROline punch W 5.5mm H 1.6mm, sheath curved to the left	89140.0101	1	
ARTHROline punch W 5.5mm H 1.6mm, sheath curved to the right	89140.0103	1	
ARTHROline hook punch W 3mm H 1.6mm, straight sheath	89140.0202	1	
Grasping forceps Ø 3.4mm	8488.096	1	
Meniscus grasping forceps Ø 4/7mm	8403.001	1	
Treatment of Cartilage Defects – Microfracture			
Curette, round, Ø 4.5mm WL 95mm	8435.902	1	Orthopedics / Knee
Curette, round, Ø 6mm WL 95mm	8435.903	1	
Microfractor WL 110mm 15°, curved	8435.951	1	
Microfractor WL 110mm 30°, curved	8435.963	1	
Microfractor WL 110mm 45°, curved	8435.952	1	
Microfractor WL 110mm 35°, curved	8435.953	1	
Microfractor WL 110mm 60°, curved	8435.956	1	
Microfractor WL 110mm 60°, curved	8435.966	1	
Microfractor WL 110mm 80°, curved	8435.968	1	
Shaver Set			
PowerSpeed AS1 MOTOR CONTROL UNIT 2305	2305001	1	Orthopedics / Motor System
Remote footswitch 2 pedals+2 buttons	2305100	1	
Motor handpiece max. 1.6000rpm	8995500031	1	
Resector toothed Ø 4.5mm	89975.0034	1	
Resector oval, Ø 4.5mm	89975.0114	1	
Resector aggress Ø 4.7mm	89975.0334	1	
Acromionizer Ø 5.5mm	89975.0555	1	
Fluid Management			
FLUID CONTROL arthro/spine suc./irrig.pump bndl	22040011	1	Orthopedics / FLUID CONTROL Suction irrigation pump
Irrigation tube set spike L 3m	4171223	1	
Imaging			
ENDOCAM Logic HD Camera Controller bndl	55251051	1	Imaging / ENDOCAM
ENDOCAM Logic HD camera head cable 3 m	85525922	1	
RIWO zoom lens F 13–29mm	85261504	1	
Light source LED 2.2 bndl	51640011	1	Imaging / Light Sources
Light source LED 1.1 bndl	51600011	1	
LCD monitor 27" 4K	LMD-X2705N	1	Imaging / Monitors
Monitor mount VESA 75/100	321165001	1	Imaging / Device Carts

Overview

arthro ^{lution}		Fingers, toes	Hand	Foot, elbow		Knee, shoulder, hip	
Telescope Ø		1.9 mm	2.4 mm	2.7 mm		4.0 mm	
Telescopes	30°	PANOVIEW telescope	8860453	8871413	8476.433	8672.422	8880.543
		PANOVIEW wide angle telescope					8885.443
	70°	PANOVIEW telescope					8880.545
		PANOVIEW wide angle telescope					8885.445
Sheath WL		40 mm	60 mm	77.5 mm	145 mm	130 mm	
Sheaths	with 1 irrigation stopcock, fixed		891220124	891220132			
	with 2 irrigation stopcocks, fixed						89121.0260
	with 1 irrigation stopcock, rotatable					891241141	
	with 2 irrigation stopcocks, rotatable			891221232	891221241	891241241	89121.1260
	High-Flow with 1 irrigation stopcock, fixed		891220128				
	High-Flow with 2 irrigation stopcocks, rotatable			891221235			89121.1263
	Small-caliber with 2 irrigation stopcocks, rotatable						891221255
Obturator	blunt				891222754		89121.0544
	semi-blunt		891221952	891222452			89121.0542
	conical blunt				891222750	891242750	89121.0540
	sharp					891242761	89121.0640
	conical pointed		891221962	891222462	891222762		
Sealing part for sheath					891040000		

|| Subject to modifications. Please note that some products may not be available in all countries. For more detailed information, please consult with your contact partner or directly with Richard Wolf GmbH.

|| Subject to modifications. Please note that some products may not be available in all countries. For more detailed information, please consult with your contact partner or directly with Richard Wolf GmbH.

Arthroscope
with PANOVIEW Telescope Ø 4 mm

Direction of view	SL	Ø	Product no.
0° PANOVIEW telescope 0° Ø 4mm SL 170mm	170 mm	4.0 mm	8880.541
30° PANOVIEW telescope 30° Ø 4mm SL 170mm			8880.543
45° PANOVIEW telescope 45° Ø 4mm SL 170mm			8880.544
70° PANOVIEW telescope 70° Ø 4mm SL 176mm			8880.545
	176 mm		

AUTOCLAVE
134° C / 273° F

Recommended accessories		Product no.
Perf. basket for standard telescope 1	(L x B x H) 297 x 59 x 54 mm	38015
Fiber light cable bndl Comprising: Fiber light cable (80663523), adapter projector side (8095.07) and adapter endoscope side (809509)	Ø 3.5 mm, 2.3 m long	806635231

Arthroscope with PANOVIEW Wide Angle Telescope

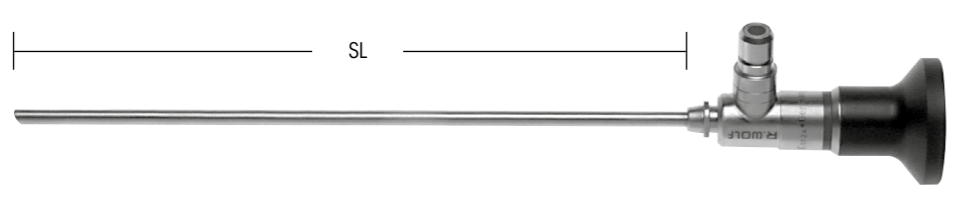

AUTOCLAVE
134° C / 273° F

Direction of view		SL	Ø	Product no.
0°	PANOVIEW Wide angle telescope 0° Ø 4mm SL 171mm	171 mm	4.0 mm	8885.441
30°	PANOVIEW Wide angle telescope 30° Ø 4mm SL 170mm	170 mm		8885.443
70°	PANOVIEW Wide angle telescope 70° Ø 4mm SL 176mm	176 mm		8885.445

Recommended accessories		Product no.
Perf. basket for standard telescope 1	(L x B x H) 297 x 59 x 54 mm	38015
Fiber light cable bndl Comprising: Fiber light cable (80663523), adapter projector side (8095.07) and adapter endoscope side (809509)	Ø 3.5 mm, 2.3 m long	806635231

|| Subject to modifications. Please note that some products may not be available in all countries. For more detailed information, please consult with your contact partner or directly with Richard Wolf GmbH.

|| Subject to modifications. Please note that some products may not be available in all countries. For more detailed information, please consult with your contact partner or directly with Richard Wolf GmbH.

arthro^{lution} Sheath for Arthroscope

with automatic click-lock mechanism

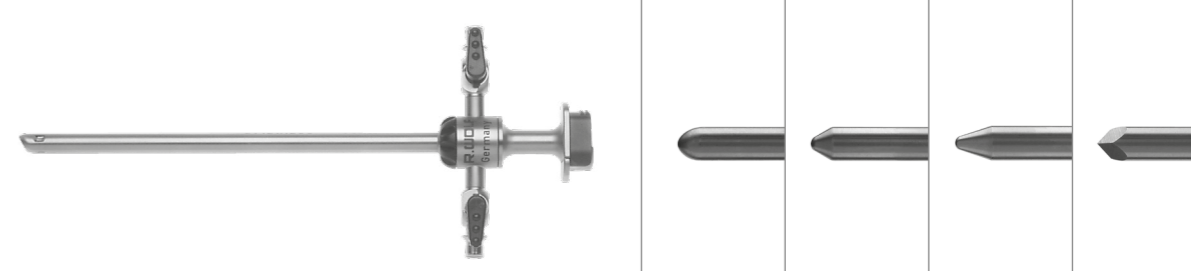

Sheath for arthroscope OD 6mm							Obturator for arthroscope 5.5/6/6.3mm blunt	Obturator for arthroscope 5.5/6/6.3mm semi-blunt	Obturator for arthroscope 5.5/6/6.3mm conical blunt	Trocar tip, triangular SZ 4mm WL 176mm
High-Flow	Small-caliber	2 fixed stopcocks	2 rotatable stopcocks	Outer Ø	WL	Product no.				
		•		6.0 mm	132 mm	89121.0260	89121.0544	89121.0542	89121.0540	89121.0640
			•	6.0 mm	130 mm	89121.1260				
•			•	6.3 mm	130 mm	89121.1263				
	•		•	5.5 mm	130 mm	891221255				

Spare parts	Product no.
Irrigation ring with 1 stopcock	150081761
Irrigation ring with 2 stopcocks	150081762
Stopcock insert, bundle, cap 3.0mm (PACK= 5 PCS) Also: Disassembly tool	896.0002 38310.0001
Mounting ring	15008.1704
Spare sealing comprising: O-rings, small / large, 5 of each Also: O-ring tool (disassembly tool)	15176.142 15106.230

Recommended accessories	Product no.
Sealing part for sheath	89101.0000
Marking rod Ø 4.0mm conical blunt TL 325 mm	8863.75

Drainage Cannula Ø 2.3 mm / 3.7 mm

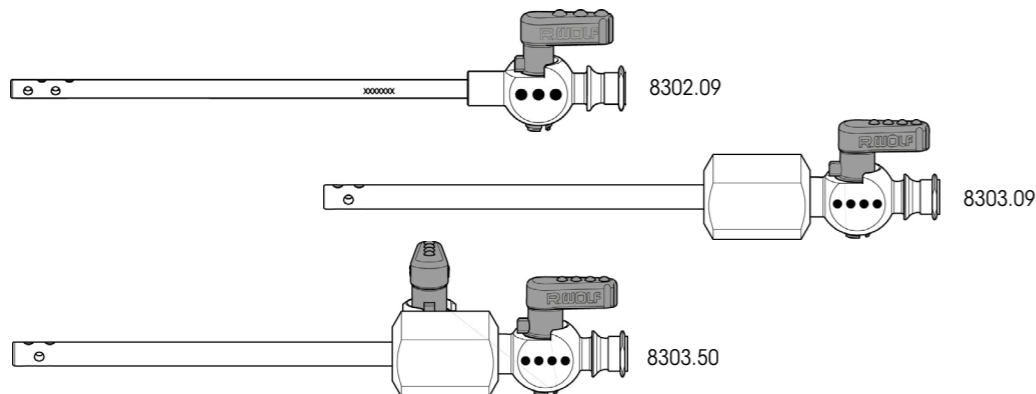

Drainage for cannula and obturator	Capacity	Ø	WL	Product no.
Drainage for cannula Ø 3.2 mm WL 80 mm with 1 insufflation stopcock	2.3 mm	3.2 mm	80 mm	8302.09
Drainage for cannula Ø 4.5 mm WL 71.5 mm with 1 insufflation stopcock	3.7 mm	4.5 mm	71.5 mm	8303.09
Drainage for cannula Ø 4.5 mm WL 71.5 mm with 2 insufflation stopcocks	3.7 mm	4.5 mm	71.5 mm	8303.50
Obturator for cannula OD 3.2 mm sharp, with slanted tip		2.3 mm	103 mm	8302.101
Obturator for cannula OD 3.2 mm conical blunt tip		2.3 mm	103 mm	8302.11
Obturator for cannula OD 4.5 mm sharp, with pyramid-shaped tip		3.7 mm	115 mm	8303.10
Obturator for cannula OD 4.4 mm conical blunt tip		3.7 mm	115 mm	8303.11
Also:				
Silicone tube with Luer fitting 886.00	for Drainage for cannula 8302.09	Length 2.0 m		8302.90
Silicone tube with Luer fitting 886.01	for Drainage for cannula 8303.09 / .50			8303.90

|| Subject to modifications. Please note that some products may not be available in all countries. For more detailed information, please consult with your contact partner or directly with Richard Wolf GmbH.

|| Subject to modifications. Please note that some products may not be available in all countries. For more detailed information, please consult with your contact partner or directly with Richard Wolf GmbH.

Hook Probe / Marking Rod



	H	WL	Product no.
Hook probe WL 115mm H 7mm, graduated	7.0 mm	115 mm	8399.901
Hook probe WL 115mm H 4.5mm, graduated	4.5 mm		8399.95







	Ø	TL	Product no.
Hook probe TL 228 mm SZ 4.4mm	4.4 mm	228 mm	8863.80



	Ø	TL	Product no.
Marking rod Ø 4.0mm conical blunt	4.0 mm	325 mm	8863.75







Version		Use
	Straight	For direct access
	Jaws curved 15° upward	Facilitates use, e.g., around the posterior horn
	Sheath curved 15° upward	Tailored to the anatomy of the condyles
	Curved to the left	Better access to the anterior and posterior meniscus
	Curved to the right	

VI121 || Subject to modifications. Please note that some products may not be available in all countries. For more detailed information, please consult with your contact partner or directly with Richard Wolf GmbH.

VI121 || Subject to modifications. Please note that some products may not be available in all countries. For more detailed information, please consult with your contact partner or directly with Richard Wolf GmbH.



Push control rod can be opened up for cleaning, disinfection, and sterilization

ARTHROline	Jaw section (Height x width)	Cut width	WL	Straight	Curved to the right	Curved to the left	Sheath curved upward	Jaw section curved upward	Product no.			
Punch W 4.6mm H 1.6mm movable jaw section serrated 	1.6 x 4.6 mm	3.3 mm	120 mm	•					89140.0105			
Punch W 4.6mm H 1.6mm movable jaw section serrated 								•		89140.0102		
Punch W 4. mm H 1.6mm movable jaw section serrated 									•		89140.0122	
Punch W 5.5mm H 1.6mm movable jaw section serrated 				1.6 x 5.5 mm						•	•	89140.0101
Punch W 5.5mm H 1.6mm movable jaw section serrated 								•			•	89140.0103

VI121 || Subject to modifications. Please note that some products may not be available in all countries. For more detailed information, please consult with your contact partner or directly with Richard Wolf GmbH.

VI121 || Subject to modifications. Please note that some products may not be available in all countries. For more detailed information, please consult with your contact partner or directly with Richard Wolf GmbH.

arthroline Hook Punch / Basket Punch

arthroline Punch / Scissors Punch



ARTHROline	Jaw section (Height x width)	Cut width	WL	Straight	Jaw section curved upward	Product no.
Hook punch W 3mm H 1.6mm Sectional view:	1.6 x 3.0 mm	1.8 mm	120 mm	•		89140.0205
Hook punch W 3mm H 1.6mm Sectional view:					•	89140.0202
Basket punch W 6.5mm H 2.1mm oval Sectional view:	2.1 x 6.5 mm	4.5 mm		•		89140.0305
Basket punch W 6.5mm H 2.1mm oval Sectional view:					•	89140.0302
Hook punch W 4mm H 2.1mm Sectional view:	2.1 x 4.0 mm	2.1 mm		•		89140.0405
Hook punch W 4 m H 2.1mm Sectional view:					•	89140.0402

ARTHROline	Jaw section (Height x width)	Cut width	WL	Straight	Retrograde cutting	Jaw section curved upward	Product no.	
Scissors punch W 2.4mm H 2.1mm Sectional view:	2.1 x 2.4 mm	0.9 mm	120 mm	•			89140.0505	
Scissors punch W 2.4mm H 2.1mm Sectional view:						•		89140.0502
Punch W 5.7mm H 4mm retrograde left-cutting Sectional view:	4.0 x 5.7 mm	2.3 mm		•	left		89140.0605	
Punch W 5.7mm H 4mm retrograde right-cutting Sectional view:						•	right	89140.0602

VI121 || Subject to modifications. Please note that some products may not be available in all countries. For more detailed information, please consult with your contact partner or directly with Richard Wolf GmbH.

VI121 || Subject to modifications. Please note that some products may not be available in all countries. For more detailed information, please consult with your contact partner or directly with Richard Wolf GmbH.

Suction Punch / Suction Grasping Forceps with Integrated Suction Channel



With integrated suction channel	Ø	WL	Product no.
Suction punch Ø 2.7mm can be dismantled	2.7 mm	110 mm	89140.0027
Suction punch Ø 4.5mm can be dismantled	4.5 mm		89140.0045

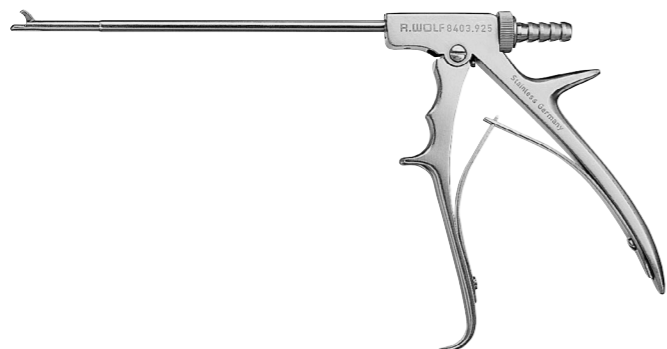









With integrated suction channel	Sheath Ø	WL	Product no.
Suction punch Ø 4.5mm straight	4.5 mm	130 mm	8403.925
Suction grasping forceps straight			8403.851

|| Subject to modifications. Please note that some products may not be available in all countries. For more detailed information, please consult with your contact partner or directly with Richard Wolf GmbH.

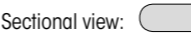
|| Subject to modifications. Please note that some products may not be available in all countries. For more detailed information, please consult with your contact partner or directly with Richard Wolf GmbH.



Hook Punch / Punch

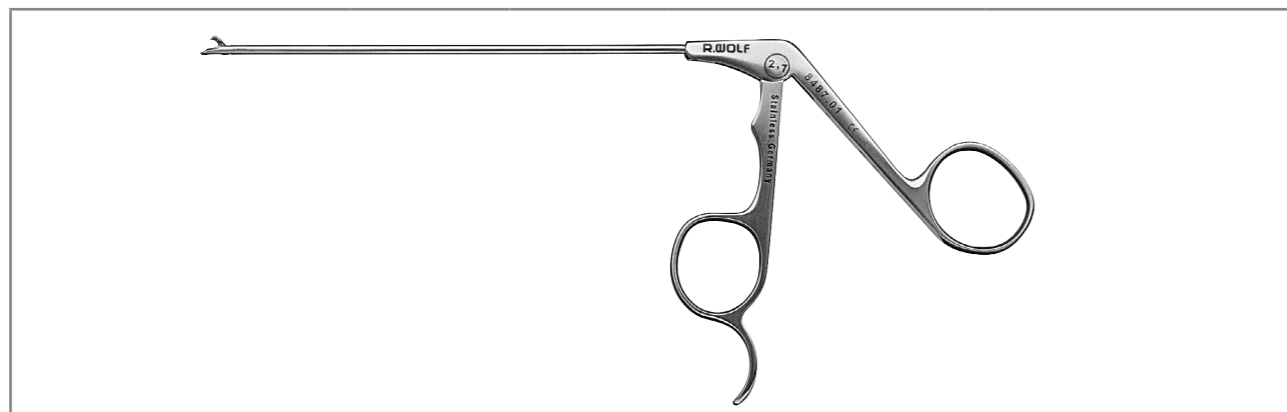

	Jaw section (Height x width)	Cut width	WL	Straight	Curved to the left	Curved to the right	Sheath curved 15° upward	Jaw section curved upward	Product no.		
Hook punch Ø 3.4mm with shovel	3.4 x 3.4 mm	1.6 mm	130 mm	•					8488.951		
					•					8488.952	
Sectional view: 						•					8488.953
								•			8488.954
Hook punch Ø 3.4mm					•				8488.02		
								•	8488.025		
Sectional view: 					•				8488.121		
Hook punch Ø 3.4mm serrated	1.93 x 3.9 mm	2.7 mm									
							•	8488.063			
Sectional view: 											
Hook punch Ø 4.5mm with shovel, serrated	1.73 x 5.4 mm	3.4 mm						•	8489.063		
											
Sectional view: 											

Punch



	Jaw section (Height x width)	Jaw section deflection	Cut width	WL	Product no.
Punch Ø 3.4mm front- and side-cutting  Sectional view: <input type="checkbox"/>	2.2 x 5.3 mm	90° left	3.4 mm	130 mm	8404.017
		90° right			8404.018
Hook punch with shovel Ø 3.4mm  Sectional view: <input type="checkbox"/>	2.1 x 2.0 mm	45° left	1.7 mm		8404.71*
		45° right			8404.81*



* particularly suitable for lateral cutting and smoothing

VI121 || Subject to modifications. Please note that some products may not be available in all countries. For more detailed information, please consult with your contact partner or directly with Richard Wolf GmbH.

VI121 || Subject to modifications. Please note that some products may not be available in all countries. For more detailed information, please consult with your contact partner or directly with Richard Wolf GmbH.

Scissors



	WL	Straight jaw section	Straight sheath	Sheath curved to the left	Sheath curved to the right	Product no.
Hook scissors Ø 3.4mm  Sectional view: <input type="checkbox"/>	130 mm	<input type="checkbox"/>	<input type="checkbox"/>	<input type="checkbox"/>	<input type="checkbox"/>	8488.04
		<input type="checkbox"/>	<input type="checkbox"/>	<input checked="" type="checkbox"/>	<input type="checkbox"/>	8488.041
		<input type="checkbox"/>	<input type="checkbox"/>	<input type="checkbox"/>	<input checked="" type="checkbox"/>	<input type="checkbox"/>
 Sectional view: <input type="checkbox"/>	130 mm	<input type="checkbox"/>	<input type="checkbox"/>	<input checked="" type="checkbox"/>	<input type="checkbox"/>	8488.052
		<input type="checkbox"/>	<input type="checkbox"/>	<input type="checkbox"/>	<input checked="" type="checkbox"/>	<input type="checkbox"/>
	WL	Jaw section deflection	Straight sheath		Product no.	
	130 mm	45° right	<input checked="" type="checkbox"/>		8404.62	

Forceps

Suture Grasping Forceps / Meniscus Grasping Forceps

Knee
1.2

Knee
1.2

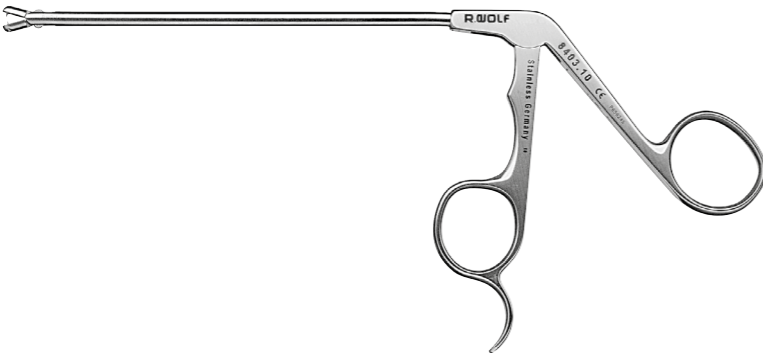

For retraction	Ø	WL	Product no.
Biopsy forceps with spike Ø 4.5mm smooth, double-action	4.5 mm	130 mm	8403.10



Handle with lock	Ø	WL	Product no.
Grasping forceps Ø 3.4mm straight jaw section, serrated	3.4 mm	130 mm	8488.096
Grasping forceps Ø 4.5mm straight jaw section, serrated	4.5 mm	134 mm	8489.096

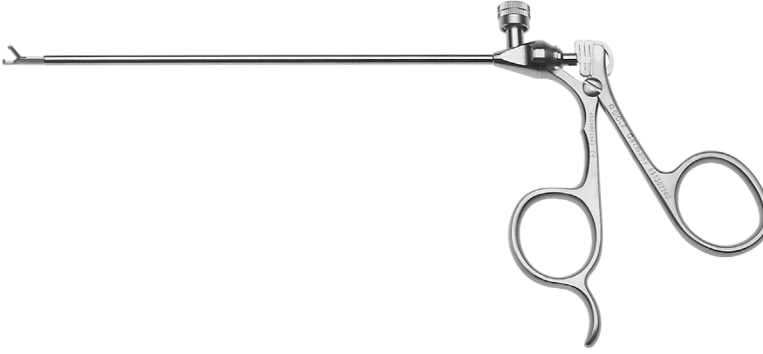

	Ø	WL	Product no.
Suture grasping forceps Ø 3.3mm Straight	3.3 mm	160 mm	891303300







Sheath with cleaning groove	Ø	WL	Product no.
Meniscus grasping forceps Ø 4/7mm with gripping tooth	4 / 7 mm	105 mm	8403.00
Meniscus grasping forceps Ø 4/7 mm			8403.001

|| Subject to modifications. Please note that some products may not be available in all countries. For more detailed information, please consult with your contact partner or directly with Richard Wolf GmbH.

|| Subject to modifications. Please note that some products may not be available in all countries. For more detailed information, please consult with your contact partner or directly with Richard Wolf GmbH.





Scalpel / Knife

	WL	Product no.
		
Straight scalpel WL 125mm		8436.101
		
Rosette knife WL 125mm		8436.151
	125 mm	8436.201
		8436.251
		8436.301

|| Subject to modifications. Please note that some products may not be available in all countries. For more detailed information, please consult with your contact partner or directly with Richard Wolf GmbH.

|| Subject to modifications. Please note that some products may not be available in all countries. For more detailed information, please consult with your contact partner or directly with Richard Wolf GmbH.

Hand Instruments
Curette

	Ø	WL	Product no.
			
Curette square Ø 4.5mm WL 170mm	4.5 mm		891632245
double-blade and curved upward			
	5.0 mm		891632260
Curette square Ø 5mm WL 170mm		170 mm	
double-blade and curved upward			
	4.8 mm		891631255
Curette round Ø 4.8mm WL 170mm			
double-blade and curved upward			
	6.3 mm		891631270
Curette round Ø 6.3mm WL 170mm			
double-blade and curved upward			

Hand Instruments
Curette







	Inner Ø	WL	Product no.
Curette, round Ø 3mm WL 95mm sharp at one end, curved upward, forward cutting 	3.0 mm	95 mm	8435.901
Curette, round Ø 4.5mm WL 95mm sharp at one end, curved upward, forward cutting 	4.5 mm		8435.902
Curette, round Ø 6mm WL 95mm sharp at one end, and curved upward, forward cutting 	6.0 mm		8435.903
Curette, round Ø 9mm WL 95mm sharp at one end, and curved upward, forward cutting 	9.0 mm		89160.1009

|| Subject to modifications. Please note that some products may not be available in all countries. For more detailed information, please consult with your contact partner or directly with Richard Wolf GmbH.

|| Subject to modifications. Please note that some products may not be available in all countries. For more detailed information, please consult with your contact partner or directly with Richard Wolf GmbH.

Hand Instruments
Microfractor



	Deflection	WL	Product no.
Microfractor WL 65mm 30° 	Curved 30°	65 mm	891643011
Microfractor WL 65mm 45° 	Curved 45°		891644511
Microfractor WL 65mm 60° 	Curved 60°		891646011

|| Subject to modifications. Please note that some products may not be available in all countries. For more detailed information, please consult with your contact partner or directly with Richard Wolf GmbH.

|| Subject to modifications. Please note that some products may not be available in all countries. For more detailed information, please consult with your contact partner or directly with Richard Wolf GmbH.

Hand Instruments
Microfractor



	Deflection	WL	Product no.
Mikrofractor WL 110mm 15°	15° curved	110 mm	8435.951
Mikrofractor WL 10mm 30°	30° curved		8435.963
Mikrofractor WL 110mm 35°	35° curved		8435.953
Mikrofractor WL 110mm 60°	60° curved		8435.956
Mikrofractor WL 110mm 60°	60° curved		8435.966
Mikrofractor WL 110mm 80°	80° curved		8435.968



	Deflection	WL	Product no.
Mikrofractor WL 110mm 45°	45° curved	110 mm	8435.952

|| Subject to modifications. Please note that some products may not be available in all countries. For more detailed information, please consult with your contact partner or directly with Richard Wolf GmbH.

|| Subject to modifications. Please note that some products may not be available in all countries. For more detailed information, please consult with your contact partner or directly with Richard Wolf GmbH.

Hand Instruments
Cartilage File, Spoon, Curette
ACL Hammer



	Version	WL	Product no.
Cartilage file straight WL 125mm W 6.25mm rough	Straight	125 mm	8436.501
Cartilage file convex WL 125mm W 6.25mm rough	Convex		8436.511
Cartilage file concave WL 125mm W 6.25mm W 6.25 mm, rough	Concave		8436.521
Spoon Ø 6.5 x 10mm WL 125mm rough	Curved		8436.601
Curette round Ø 5mm WL 125mm double-blade	Angled		8436.701



	TL	Product no.
ACL hammer TL 248mm	248 mm	8866.956



Modular concept

The system's outstanding performance is provided by its unparalleled diversity and universality. **Graftline** offers highly specialized – and in some cases patented – technology for a huge range of surgical options.

- **Efficiency goes hand in hand.** Minimal handles and intuitive connection options for all instruments save on space and weight.
- **ACL and PCL in one instrument.** **Graftline** provides the instruments for anterior and posterior cruciate ligament plastic surgery in intelligent combinations.
- **Well prepared for optimum grip.** With the Graftline instruments and implants, the surgeon is perfectly prepared for all eventualities, for example, if reruptures occur.

A choice of fixing options

Graftline allows the ideal fixation method to be selected for the cruciate ligament graft, without the need for major adjustments. We offer a tried-and-tested range of fixing implants.

Unique perspectives

Graftline gives surgeons access to all methodological channels – from standard techniques to innovative specific solutions. BTB, BT grafts, hamstrings, allografts, oval tunnel technique, and hollow-burr technique: one system – a wealth of possibilities.

VI121 || Subject to modifications. Please note that some products may not be available in all countries. For more detailed information, please consult with your contact partner or directly with Richard Wolf GmbH.

VI121 || Subject to modifications. Please note that some products may not be available in all countries. For more detailed information, please consult with your contact partner or directly with Richard Wolf GmbH.

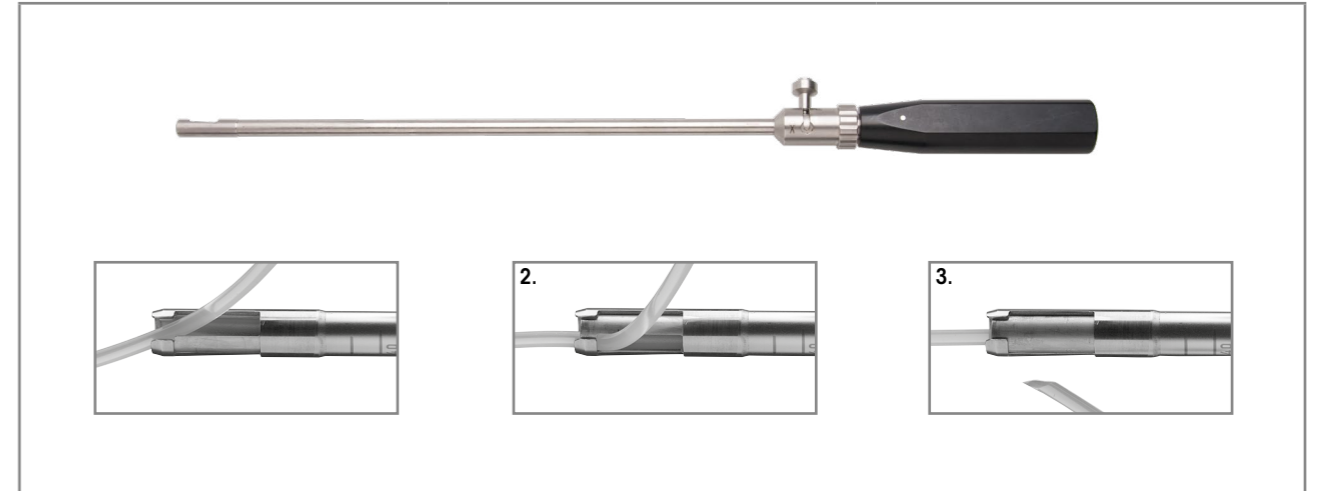

		1. Retract	2. Secure	3. Sever		
				Ring Ø	WL	Product no.
 Tendon stripper, universal 300mm, SZ8 mm by Pässler	<ul style="list-style-type: none"> ■ Universal use: open / closable / cutting function ■ Blunt distal end ■ Can be disassembled 			8.0 mm	300 mm	8866.951

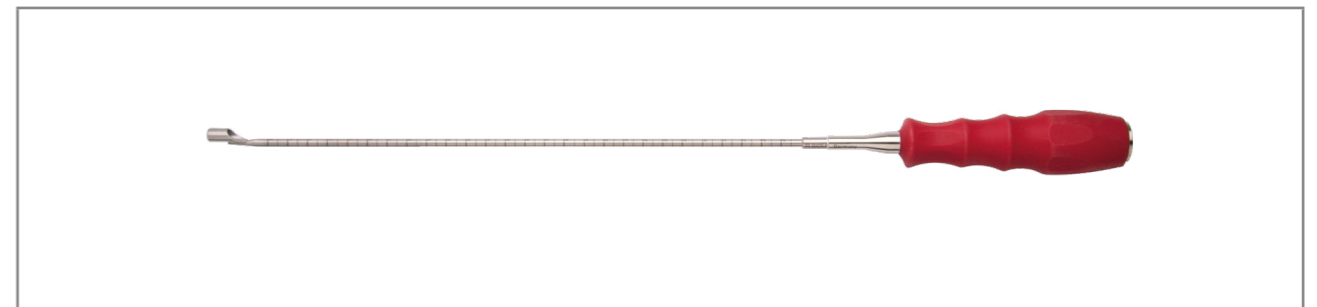

		Ring Ø	WL	Product no.
 Tendon stripper, standard 300 mm, size 7 mm	<ul style="list-style-type: none"> ■ Closed ■ Sharp distal end 	8.0 mm	300 mm	891610070



		Inner Ø	Outer Ø	WL	Product no.
Hollow burr SZ 8	<ul style="list-style-type: none"> For efficient removal of the bone blocks for BT or BTB transplants when using the quadriceps or patellar tendon For application with the bee-system II oscillating ream machine F-31-700-00 	8,4 mm	9,4 mm	90 mm	8869.841
Hollow burr SZ 9		9,4 mm	10,4 mm		8869.843
Hollow burr SZ 10		10,4 mm	11,4 mm		8869.844



		Inner Ø	Outer Ø	WL	Product no.
Hollow drill bit SZ 8	<ul style="list-style-type: none"> For application with the bee-system II oscillating ream machine F-31-700-00 	7,4 mm	8,5 mm	185 mm	8869849
Hollow drill bit SZ 9		8,4 mm	9,5 mm		8869.851
Hollow drill bit SZ10		9,4 mm	10,5 mm		8869.852



		Inner Ø	Outer Ø	WL	Product no.
Bone elevator SZ 8	<ul style="list-style-type: none"> Harvesting the bone blocks from the patella after using hollow burrs Different diameters to remove the bones blocks 	8,4 mm	11,1 mm	130 mm	8868.921
Bone elevator SZ 9		9,4 mm	11,2 mm		8868.922
Bone elevator SZ 10		10,5 mm	12,5 mm		8868.923





		Outer Ø	WL	Product no.
Suture puller WL 350mm	<ul style="list-style-type: none"> Passing the threads to pull in the transplant into the hollow burrs 	4 mm	350 mm	8869.921



|| Subject to modifications. Please note that some products may not be available in all countries. For more detailed information, please consult with your contact partner or directly with Richard Wolf GmbH.

|| Subject to modifications. Please note that some products may not be available in all countries. For more detailed information, please consult with your contact partner or directly with Richard Wolf GmbH.

Knee
1.5

Knee
1.5

		WL	Product no.
	<ul style="list-style-type: none"> For introducing the cylindrical bone plug into the femoral tunnel For use via the transibiale portal 	110 mm	8869.991
Curved plunger WL 110mm			

		WL	Product no.
	<ul style="list-style-type: none"> For introducing the cylindrical bone plug into the femoral tunnel For use via the anteromedial portal 	110 mm	8869.993
Pusher straight WL 110mm			

VI121 || Subject to modifications. Please note that some products may not be available in all countries. For more detailed information, please consult with your contact partner or directly with Richard Wolf GmbH.



VI121 || Subject to modifications. Please note that some products may not be available in all countries. For more detailed information, please consult with your contact partner or directly with Richard Wolf GmbH.

		Product no.
	Preparation table, tendon prep. bndl consisting of: Preparation table (88669023) Preparation plate (8866905) Transplant template SZ 5-13mm (8866953) Clamp insert (8866962) Hook clamp (8866935) Parallel screw clamp (8866961) RIWObutton interface (8866969) Tendon transplantat BT / BTB 6mm (8866966) don transplantat BT / BTB 8mm (8866968) Leading hook (8866936)	88669700
	Preparation table (LxWxH) 390 mm x 190 mm x 6 mm	88669023
	Preparation plate (LxB) 380 mm x 60 mm	8866905
	Transplant template SZ 5-13mm oval-shaped tunnels D 5 x 10, D 6 x 12, D 7 x 14	8866953
	Clamp insert	8866962
	Hook clamp	8866935
	Parallel screw clamp	8866961
	RIWObutton interface	8866969
	Tendon transplantat BT / BTB 6mm	8866966
	Tendon transplantat BT / BTB 8mm	8866968
	Leading hook	8866936

	With coupling	Inner Ø	Product no.
 Modular handle I-shaped cannulated	●	3.5 mm	893011135
 Modular handle impact / deflection plate cannulated		3.5 mm	893011136
 Handle I-shaped ID 3.2mm cannulated		3.2 mm	893011132
 Modular handle, t-shaped cannulated		4.0 mm	893011137

VI121 || Subject to modifications. Please note that some products may not be available in all countries. For more detailed information, please consult with your contact partner or directly with Richard Wolf GmbH.



VI121 || Subject to modifications. Please note that some products may not be available in all countries. For more detailed information, please consult with your contact partner or directly with Richard Wolf GmbH.

 891013 050/060/070/080/510/612/714

 891014070/080/090/100

ACL		Size	Color coding	Ø	WL	Product no.
	ACL aiming device SZ 5mm	5 mm	blue	2.5 mm	120 mm	891013050
	ACL aiming device SZ 6mm	6 mm	green			891013060
	ACL aiming device SZ 7mm	7 mm	red			891013070
	ACL aiming device SZ 8mm	8 mm	none			891013080
cannulated, for the anteromedial portal	ACL aiming device SZ 5x10mm	oval 5 x 10 mm	blue	2.5 mm	120 mm	891013510
	ACL aiming device SZ 6x12mm	oval 6 x 12 mm	green			891013612
	ACL aiming device SZ 7x14mm	oval 7 x 14 mm	red			891013714
cannulated, for the anteromedial portal	ACL aiming device AT SZ 5mm	5 mm	blue	2.5 mm	120 mm	891015050
	ACL aiming device AT SZ 6mm	6 mm	green			891015060
	ACL aiming device AT SZ 7mm	7 mm	red			891015070
cannulated, for the transfibial portal	PCL					
	PCL aiming device AL SZ 7mm	7 mm	red	2.5 mm	120 mm	891014070
	PCL aiming device AL SZ 8mm	8 mm	none			891014080
	PCL aiming device AL SZ 9mm	9 mm	yellow			891014090
PCL aiming device AL SZ 10mm	10 mm	white	891014100			

● For use with the modular handles

UniCracker





For use with the modular handles		WL	Product no.
 <p>Univ. tunnel notcher Ø 4–9 mm WL 130mm</p>	Impacting chisel for indentation of the tunnel from Ø 4 to 9 mm, cannulated 2.5 mm	130 mm	891611110



For use with the modular handles		WL	Product no.
 <p>Notch chisel WL 130mm one-sided grinding cannulated, Ø 2.5 mm</p>	Gentle graft fixation when using interference screws	130 mm	891511000



		WL	Product no.
 <p>Tunnel probe WL 140 mm graduated</p>	For determining the length of the femoral tunnel – particularly when using the RIWObutton to determine the loop length	140 mm	891510012

VI121 || Subject to modifications. Please note that some products may not be available in all countries. For more detailed information, please consult with your contact partner or directly with Richard Wolf GmbH.



VI121 || Subject to modifications. Please note that some products may not be available in all countries. For more detailed information, please consult with your contact partner or directly with Richard Wolf GmbH.

For use with the modular handles		Size	Color coding	WL	Product no.
 <p>Tunnel rasp oval, cannulated Ø 2.5 mm</p>	Tunnel rasp Ø 5 x 10mm WL 130mm	5 x 10 mm	blue	130 mm	891611101
	Tunnel rasp Ø 6 x 12mm WL 130mm	6 x 12 mm	green		891611102
	Tunnel rasp Ø 7 x 14mm WL 130mm	7 x 14 mm	red		891611103









For preparing the oval-shaped femoral tunnel on the joint side



For use with the modular handles		Ø	WL	Product no.
 <p>Compactor cannulated Ø 2.5 mm graduated</p>	Compactor SZ 8	8.0	290 mm	891511708
	Compactor SZ 9	9.0		891511709
	Compactor SZ 10	10.0		891511710
<p>Compacting the spongiosa during simultaneous, asymmetric formation of the femoral tunnel using a compactor head flattened at the side. For the positioning and press-fit anchorage of bone plugs for BT and BTB grafts.</p> <p>■ For use with the modular handles</p>				
Also:				
	Deflection sleeve	For removal of compactors		8868.992
	Tunnel stopper	For the direct closure of tibial drill holes		8868.941



VI121 || Subject to modifications. Please note that some products may not be available in all countries. For more detailed information, please consult with your contact partner or directly with Richard Wolf GmbH.



VI121 || Subject to modifications. Please note that some products may not be available in all countries. For more detailed information, please consult with your contact partner or directly with Richard Wolf GmbH.

Single bundle ACL reconstruction				
		Adjustable alignment device bndl consisting of:	Product no.bndl	
		Product no.	8874.013	8874.014
				
	Base section for standard tibial, graduated for alignment hook and spoon and for drill guide	8874.113	•	•
	Aiming spoon tibial ACL	8874.123		•
	Aiming hook tibial ACL	8874.121	•	
		8874.131	•	•
		Alignment wire guide standard SZ 2.5		
Double-bundle ACL reconstruction				Product no.
	Alignment ARC ZG tibial ACL right	For the double-bundle technique on the right knee		8874130
	Zielbügel ZG Tibial ACL links DB	For the double-bundle technique on the left knee		88741301
PCL reconstruction				Product no.
	Aiming spoon ZG tibial			8874129



Hollow drill bit and Ejector	Inner Ø	Outer Ø	WL	Product no.
Hollow drill bit SZ 8	8,5 mm	7,4 mm	185	8869849
also: Ejector SZ 8				8869850
Hollow drill bit 9	9,5 mm	8,4 mm	185 mm	8869.851
also: Ejector SZ 9				8869.852
Hollow drill bit 10	10,5 mm	9,4 mm	185 mm	8869.853
also: Ejector SZ 10				8869.854



Base section, aiming spoon and aiming hook		Product no.
	Base section for tibial drill graduated	8874.111
	Aiming hook tibial ACL	8874.121
	Aiming spoon tibial ACL	8874.123

Alignment wire guide hollow drill SZ 2.5		Product no.
	Alignment wire guide hollow drill SZ 2.5 for use with base section 8874.111	8874.151
	Drill guide for hollow drill bit SZ 8 for use with base section 8874.111 and hollow drill bit 8869849 SZ 8	8874150
	Drill guide for hollow drill bit SZ 9 for use with base section 8874.111 and hollow drill bit 8869.851 SZ 9	8874.152
	Drill guide for hollow drill bit SZ 10 for use with base section 8874.111 and hollow drill bit 8869.853 SZ 10	8874.153

|| Subject to modifications. Please note that some products may not be available in all countries. For more detailed information, please consult with your contact partner or directly with Richard Wolf GmbH.

|| Subject to modifications. Please note that some products may not be available in all countries. For more detailed information, please consult with your contact partner or directly with Richard Wolf GmbH.







	WL	Ø	Product no.
	150 mm	5,0 mm	891511005
		5,5 mm	891511055
		6,0 mm	891511006
		6,5 mm	891511065
		7,0 mm	891511007
		7,5 mm	891511075
		8,0 mm	891511008
		8,5 mm	891511085
		9,0 mm	891511009
		9,5 mm	891511095
		10,0 mm	891511010
		10,5 mm	891511105
		11,0 mm	891511011
		also:	
	Modular handle, t-shaped with coupling, cannulated		893011137

|| Subject to modifications. Please note that some products may not be available in all countries. For more detailed information, please consult with your contact partner or directly with Richard Wolf GmbH.

|| Subject to modifications. Please note that some products may not be available in all countries. For more detailed information, please consult with your contact partner or directly with Richard Wolf GmbH.

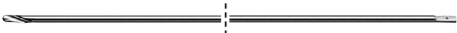



graft^{line}
Preparing the Tibial Tunnel
Cannulated head drill

	WL	Ø	Product no.
  <p>Head drill cannulated, Ø 2.65 mm TiN coating</p> <p>For alignment wire / Kirschner wire Ø 2.5 mm</p>	145 mm	4.5 mm	89960.1045
		5.0 mm	89960.1050
		5.5 mm	89960.1055
		6.0 mm	89960.1060
		6.5 mm	89960.1065
		7.0 mm	89960.1070
		7.5 mm	89960.1075
		8.0 mm	89960.1080
		8.5 mm	89960.1085
		9.0 mm	89960.1090
		9.5 mm	89960.1095
		10.0 mm	89960.1010
		10.5 mm	89960.1910
		11.0 mm	89960.1011
11.5 mm	89960.1911		
12.5 mm	89960.1012		
12.5 mm	89960.1912		
13.0 mm	89960.1013		
 <p>Kirschner alignment wire Ø 2.5mm triangular grinding</p>	TL 300 mm without suture eyelet	2.5 mm	89120.3025
 <p>Kirschner alignment wire Ø 2.5mm spiral grinding</p>	TL 310 mm without suture eyelet	2.5 mm	89960.1025
 <p>Kirschner alignment wire Ø 2.5mm spiral grinding</p>	TL 430 mm with suture eyelet	2.5 mm	89960.1125

|| Subject to modifications. Please note that some products may not be available in all countries. For more detailed information, please consult with your contact partner or directly with Richard Wolf GmbH.

|| Subject to modifications. Please note that some products may not be available in all countries. For more detailed information, please consult with your contact partner or directly with Richard Wolf GmbH.

graft^{line}
Perforated Baskets for Instruments
Knee Arthroscopy
Sterilization – storage – transport

Illustration	Description	Product no.
 <p>Perf. basket – knee arthrosc. Basic set</p>	<p>Holds: knee arthroscopy basic set, for sterilization (steam and low-temperature), storage and transport, with instrument holders, inner dimensions (wxhxd): 513x134x233mm, outer dimensions (wxhxd): 549x150x250mm</p>	33007
 <p>Perf. basket – knee arthrosc. ACL/PCL 1</p>	<p>Holds: instrument set for knee arthroscopy ACL/PCL 1, for sterilization (steam and low-temperature), storage and transport, with instrument holders, inner dimensions (wxhxd): 513x134x233mm, outer dimensions (wxhxd): 549x150x250mm</p>	33008
 <p>Perf. basket – knee arthrosc. ACL/PCL 2</p>	<p>Holds: instrument set for knee arthroscopy ACL/PCL 2, for sterilization (steam and low-temperature), storage and transport, with instrument holders, inner dimensions (wxhxd): 513x134x233mm, outer dimensions (wxhxd): 549x150x250mm</p>	33009
 <p>Perf. basket For knee arthrosc. prep tab</p>	<p>Holds: knee arthroscopy preparation table, for sterilization (steam and low-temperature), storage and transport, with instrument holders, inner dimensions (wxhxd): 513x134x233mm, outer dimensions (wxhxd): 549x150x250mm</p>	33010

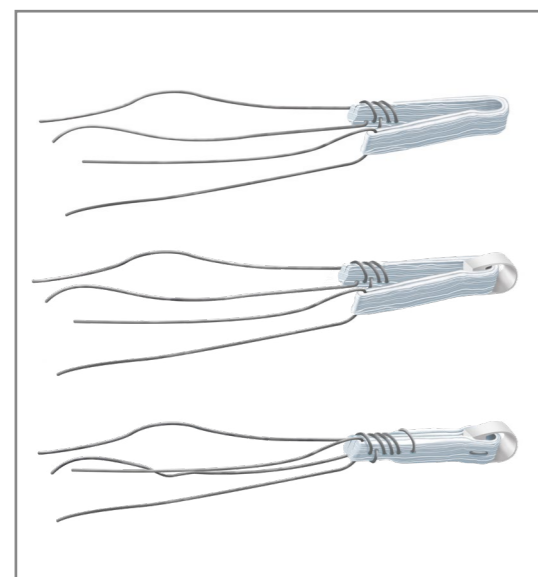

passend für Standard Container (1 STE = 1 Sterilguteinheit)

Tendon anchor		Size	Product no.
 <p>T-Lock OSTEOTRANS</p> <p>T-Lock OSTEOTRANS tendon anchor, sterile</p>		6	OLRA-6
		7	OLRA-7
		8	OLRA-8
		9	OLRA-9





BioactIF OSTEOTRANS

"OK" interference screws

	Thread Ø	Length	Hole	Product no.
BioactIF OSTEOTRANS 7 X 25, sterile	/ mm	25 mm	2.2 mm	OK0725A
BioactIF OSTEOTRANS 7 X 30, sterile		30 mm		OK0730A
BioactIF OSTEOTRANS 8 X 25, sterile	8 mm	25 mm		OK0825
BioactIF OSTEOTRANS 8 X 30, sterile		30 mm		OK0830
BioactIF OSTEOTRANS 9 X 25, sterile	9 mm	25 mm		OK0925
BioactIF OSTEOTRANS 9 X 30, sterile		30 mm		OK0930



Screwdriver	For interference screws with thread size	Product no.
 <p>Screwdriver OK/BK SZ 7 -11 mm cannulated, color code red, graduated</p>	7-11 mm	891800030



Thread cutter	For OK screws	Product no.
 <p>Thread cutter for OK screws SZ 7 mm</p>	Size 7 mm	891800700
Thread cutter for OK screws SZ 8 mm	Size 8 mm	891800800
Thread cutter for OK screws SZ 9 mm	Size 9 mm	891800900



Guide wire	Ø	TL	Product no.
 <p>Nitinol guide wire Ø 1.2mm</p>	1.2 mm	350 mm	89120.2012

VI121 || Subject to modifications. Please note that some products may not be available in all countries. For more detailed information, please consult with your contact partner or directly with Richard Wolf GmbH.

VI121 || Subject to modifications. Please note that some products may not be available in all countries. For more detailed information, please consult with your contact partner or directly with Richard Wolf GmbH.

Bioact^{IF} OSTEOTRANS

"BK" interference screws

	Thread Ø	Length	Hole	Product no.
BioactIF OSTEOTRANS 6 X 20, sterile	6 mm	20 mm	1.7 mm	BK0620
BioactIF OSTEOTRANS 7 X 20, sterile	7 mm	20 mm		BK0720
BioactIF OSTEOTRANS 7 X 25, sterile		25 mm		BK0725
BioactIF OSTEOTRANS 7 X 30, sterile		30 mm		BK0730
BioactIF OSTEOTRANS 8 X 20, sterile		20 mm		BK0820
BioactIF OSTEOTRANS 8 X 25, sterile	8 mm	25 mm		BK0825
BioactIF OSTEOTRANS 8 X 30, sterile		30 mm		BK0830
BioactIF OSTEOTRANS 9 X 20, sterile	9 mm	20 mm		BK0920
BioactIF OSTEOTRANS 9 X 25, sterile		25 mm		BK0925
BioactIF OSTEOTRANS 9 X 30, sterile		30 mm		BK0930
BioactIF OSTEOTRANS 10 X 25, sterile	10 mm	25 mm	BK1025	
BioactIF OSTEOTRANS 10 X 30, sterile		30 mm	BK1030	





891800020



891800030

Screwdriver		for interference screws with thread size	Product no.
	Screwdriver BK SZ 6MM cannulated, color code black, graduated	6 mm	891800020
	Screwdriver OK/BK SZ 7 -11mm cannulated, color code red, graduated	7-11 mm	891800030





Guide wire		Ø	TL	Product no.
	Nitinol guide wire Ø 1.2mm	1.2 mm	350 mm	89120.2012

|| Subject to modifications. Please note that some products may not be available in all countries. For more detailed information, please consult with your contact partner or directly with Richard Wolf GmbH.

|| Subject to modifications. Please note that some products may not be available in all countries. For more detailed information, please consult with your contact partner or directly with Richard Wolf GmbH.

Bioact^{IF} OSTEOTRANS

"RK" interference screws



conical, absorbable, sterile	Thread Ø	Length	Hole	Product no.
Bioactif OSTEOTRANS OD 6mm L 20mm	6 mm	20 mm	1,5 mm	RK0620
Bioactif OSTEOTRANS OD 7mm L 20mm	7 mm	20 mm		RK0720
Bioactif OSTEOTRANS OD 7mm L 25mm		25 mm		RK0725
Bioactif OSTEOTRANS OD 7mm L 30mm		30 mm		RK0730
Bioactif OSTEOTRANS OD 8mm L 20mm		8 mm		20 mm
Bioactif OSTEOTRANS OD 8mm L 25mm	25 mm			RK0825
Bioactif OSTEOTRANS OD 8mm L 30mm	30 mm			RK0830
Bioactif OSTEOTRANS OD 9mm L 20mm	9 mm	20 mm		RK0920
Bioactif OSTEOTRANS OD 9mm L 25mm		25 mm		RK0925
Bioactif OSTEOTRANS OD 9mm L 30mm		30 mm		RK0930
Bioactif OSTEOTRANS OD 10mm L 25mm	10 mm	25 mm	RK1025	



891800021



891800031

		for interference screws with thread size	Product no.
	Screwdriver RK SZ 5 -6mm cannulated, color code red, graduated	6 mm	891800021
	Screwdriver RK GR 7 -11mm cannulated, color code yellow, graduated	7 - 11 mm	891800031

graft^{line}

Graft Fixation

Guide Wire



Guide wire	Ø	TL	Product no.
	Nitinol guide wire Ø 1.2mm	1.2 mm	350 mm 89120.2012

Knee

1.5



Shoulder

Shoulder

1 Standard Equipment / Arthroscopes

2 ARTHROline Punches

3 Hook Probe / Marking Rod

4 Reconstructive Shoulder Arthroscopy

Basic Equipment

for shoulder arthroscopy

Product	Product no.	Quantity	Catalog / Section
Endoscopes and Instruments			
PANOVIEW telescope 30° Ø 4mm SL 170mm	8880.543	1	Orthopedics / Shoulder
Fiber light cable bndl, Ø 3.5mm, 2.3m long	806635231	1	
Sheath for arthroscope OD 6mm	89121.1260	1	
Obturator for arthroscope OD 5.5/6/6.3mm tip, semi-blunt	89121.0542	1	
Hook probe WL 115mm H 4.5mm graduated	8399.95	1	
ARTHROline punch W 4.6mm H 1.6mm jaws curved upward	89140.0102	1	
ARTHROline punch W 5.5mm H 1.6mm jaws curved upward, sheath curved to the left	89140.0103	1	
ARTHROline punch W 4.6mm H 1.6mm jaw section serrated, sheath curved upward	89140.0122	1	
ARTHROline hook punch W 4mm H 21.1mm straight jaw section	89140.0405	1	

Overview

arthro ^{lution}		Fingers, toes	Hand	Foot, elbow		Knee, shoulder, hip	
Telescope Ø		1.9 mm	2.4 mm	2.7 mm		4.0 mm	
Telescopes	30°	PANOVIEW telescope	8860453	8871413	8476.433	8672.422	8880.543
		PANOVIEW wide angle telescope					8885.443
	70°	PANOVIEW telescope					8880.545
		PANOVIEW wide angle telescope					8885.445
Sheath WL		40 mm	60 mm	77.5 mm	145 mm	130 mm	
Sheaths	with 1 irrigation stopcock, fixed		891220124	891220132			
	with 2 irrigation stopcocks, fixed						89121.0260
	with 1 irrigation stopcock, rotatable					891241141	
	with 2 irrigation stopcocks, rotatable			891221232	891221241	891241241	89121.1260
	High-Flow with 1 irrigation stopcock, fixed		891220128				
	High-Flow with 2 irrigation stopcocks, rotatable			891221235			89121.1263
	Small-caliber with 2 irrigation stopcocks, rotatable						891221255
Obturator	blunt				891222754		89121.0544
	semi-blunt		891221952	891222452			89121.0542
	conical blunt				891222750	891242750	89121.0540
	sharp					891242761	89121.0640
	conical pointed		891221962	891222462	891222762		
Sealing part for sheath					891040000		

|| Subject to modifications. Please note that some products may not be available in all countries. For more detailed information, please consult with your contact partner or directly with Richard Wolf GmbH.

|| Subject to modifications. Please note that some products may not be available in all countries. For more detailed information, please consult with your contact partner or directly with Richard Wolf GmbH.

Arthroscope
with PANOVIEW Telescope Ø 4 mm

Direction of view	SL	Ø	Product no.
0° PANOVIEW telescope 0° Ø 4mm SL 170mm	170 mm	4.0 mm	8880.541
30° PANOVIEW telescope 30° Ø 4mm SL 170mm			8880.543
45° PANOVIEW telescope 45° Ø 4mm SL 170mm			8880.544
70° PANOVIEW telescope 70° Ø 4mm SL 176mm			176 mm

AUTOCLAVE
134° C / 273° F

Recommended accessories		Product no.
Perf. basket for standard telescope 1	(L x B x H) 297 x 59 x 54 mm	38015
Fiber light cable bndl Comprising: Fiber light cable (80663523), adapter projector side (8095.07) and adapter endoscope side (809509)	Ø 3.5 mm, 2.3 m long	806635231

arthro Sheath for Arthroscope
lution

with automatic click-lock mechanism

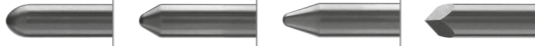
													
Sheath for arthroscope OD 6mm							Obturator for arthroscope 5.5/6/6.3mm blunt	Obturator for arthroscope 5.5/6/6.3mm semi-blunt	Obturator for arthroscope 5.5/6/6.3mm conical blunt	Trocar tip, triangular SZ 4mm WL 176mm			
High-Flow	Small-caliber	2 fixed stopcocks	2 rotatable stopcocks	Outer Ø	WL	Product no.							
		•		6.0 mm	132 mm	89121.0260							
			•	6.0 mm	130 mm	89121.1260							
•			•	6.3 mm	130 mm	89121.1263	89121.0544	89121.0542	89121.0540	89121.0640			
	•		•	5.5 mm	130 mm	891221255							

Spare parts	Product no.
Irrigation ring with 1 stopcock	150081761
Irrigation ring with 2 stopcocks	150081762
Stopcock insert, bundle, cap 3.0mm (PACK= 5 PCS) Also: Disassembly tool	896.0002 38310.0001
Mounting ring	15008.1704
Spare sealing comprising: O-rings, small / large, 5 of each Also: O-ring tool (disassembly tool)	15176.142 15106.230

Recommended accessories	Product no.
Sealing part for sheath	89101.0000
Marking rod Ø 4.0mm conical blunt TL 325 mm	8863.75

VI121 || Subject to modifications. Please note that some products may not be available in all countries. For more detailed information, please consult with your contact partner or directly with Richard Wolf GmbH.

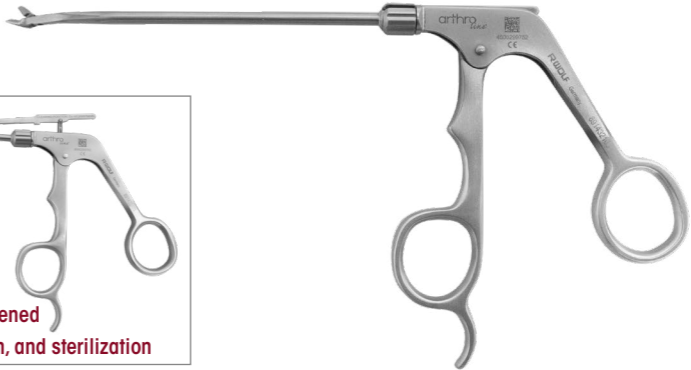

VI121 || Subject to modifications. Please note that some products may not be available in all countries. For more detailed information, please consult with your contact partner or directly with Richard Wolf GmbH.

arthro Punch
line

									
Push control rod can be opened up for cleaning, disinfection, and sterilization									
ARTHROline	Jaw section (Height x width)	Cut width	WL	Straight	Curved to the right	Curved to the left	Sheath curved upward	Jaw section curved upward	Product no.
Punch W 4.6mm H 1.6mm movable jaw section serrated	1.6 x 4.6 mm	3.3 mm	120 mm	•					89140.0105
Punch W 4.6mm H 1.6mm movable jaw section serrated							•		89140.0102
Punch W 4. mm H 1.6mm movable jaw section serrated	1.6 x 5.5 mm	3.3 mm	120 mm				•		89140.0122
Punch W 5.5mm H 1.6mm movable jaw section serrated							•	•	89140.0101
Punch W 5.5mm H 1.6mm movable jaw section serrated							•		•

Hook Probe / Marking Rod



	H	WL	Product no.
Hook probe WL 115mm H 7mm, graduated 	7.0 mm	115 mm	8399.901
Hook probe WL 115mm H 4.5mm, graduated 	4.5 mm		

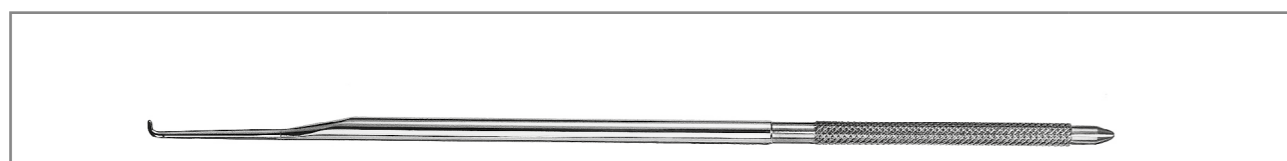

	Ø	TL	Product no.
Hook probe TL 228 mm SZ 4.4mm 	4.4 mm	228 mm	8863.80

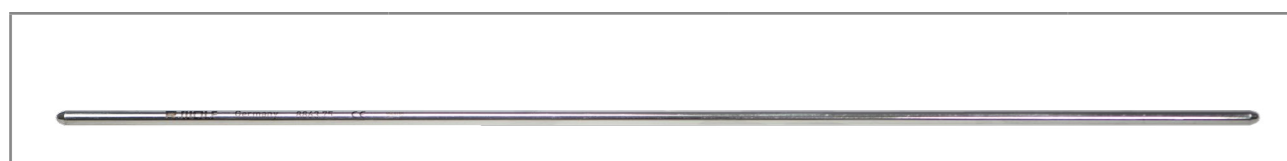

	Ø	TL	Product no.
Marking rod Ø 4.0mm conical blunt 	4.0 mm	325 mm	8863.75

|| Subject to modifications. Please note that some products may not be available in all countries. For more detailed information, please consult with your contact partner or directly with Richard Wolf GmbH.

|| Subject to modifications. Please note that some products may not be available in all countries. For more detailed information, please consult with your contact partner or directly with Richard Wolf GmbH.

Basic Instrument Set

for reconstructive shoulder arthroscopy

Product	Product no.	Quantity	Catalog / Section
Endoscopes and Instruments			
Knot pusher WL 170mm	89150.3000	1	Orthopedics / Shoulder
Suture catcher WL 160mm	89150.3003	1	
Concave rasp WL 175mm W 4.75mm	89160.3003	1	
Convex rasp WL 175 mm W 4.75mm	89160.3002	1	
Straight rasp WL 175mm W 4.75mm	89160.3005	1	
Knife angled 15° WL 160mm W 4.5mm	89160.3015	1	
Distally cutting knife WL 160mm W 4.5mm	89160.3001	1	
Suture cutter Ø 5mm WL 200mm	891603000	1	
Suture grasping forceps Ø 3.3mm	891303300	1	
Grasping forceps Ø 3.4mm	8488.096	1	
Marking rod Ø 4.0mm, conical blunt	8863.75	1	
ENDOSPIKE shoulder suture instrument Ø 5.3mm	891403000	1	
Also: Needles for suture forceps, sterile	491403000	1	
Perf. basket for shoulder arthroscopy	33012	1	

Endospike

Shoulder Suture Instrument



	Ø	WL	Product no.
ENDOSPIKE shoulder suture instrument Ø 5.3mm	5.3 mm	169 mm	891403000
with irrigation connector, can be dismantled			
Also:			
Needles for stitching forceps, sterile, disposable (PACK= 5 PCS)			491403000

VI121 || Subject to modifications. Please note that some products may not be available in all countries. For more detailed information, please consult with your contact partner or directly with Richard Wolf GmbH.

VI121 || Subject to modifications. Please note that some products may not be available in all countries. For more detailed information, please consult with your contact partner or directly with Richard Wolf GmbH.

Suture Cutter / Suture Grasping Forceps

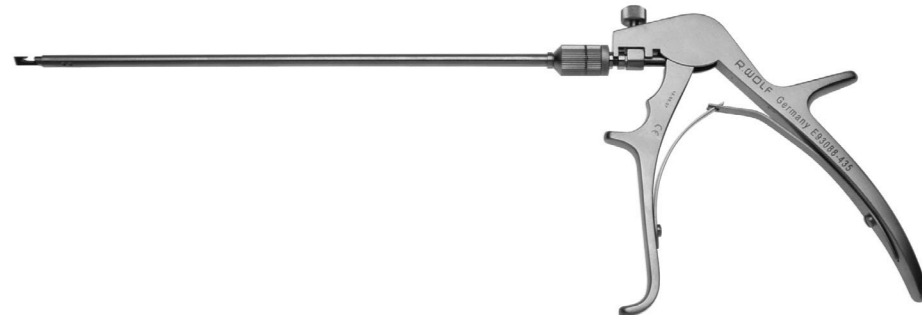

	Ø	WL	Product no.
Suture cutter Ø 5mm WL 200mm	5.0 mm	200 mm	891603000
can be dismantled			

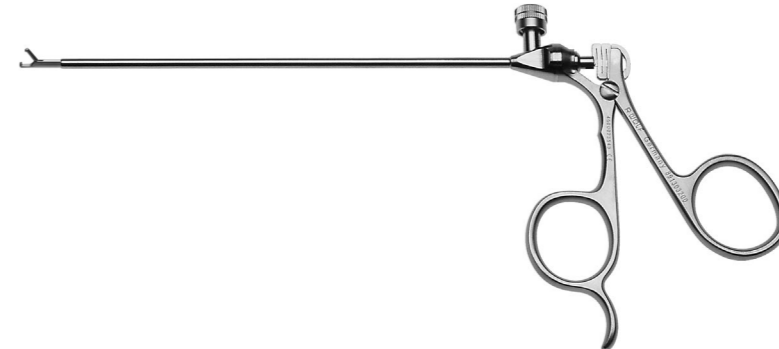

	Ø	WL	Product no.
Suture grasping forceps Ø 3.3mm	3.3 mm	160 mm	891303300
jaw section straight, sheath straight			
Suture grasping forceps Ø 3.3mm			
straight jaw section, pointed			891303200
Suture grasping forceps Ø 3.3mm			
jaw section curved 45° upward, pointed			891303230

Grasping Forceps

			
	Ø	WL	Product no.
Grasping forceps Ø 3.4mm	3.4 mm	130 mm	8488.096
straight jaw section, serrated, handle with lock			

Grasping forceps for holding and repositioning the rotator cuff.

VI121 || Subject to modifications. Please note that some products may not be available in all countries. For more detailed information, please consult with your contact partner or directly with Richard Wolf GmbH.

VI121 || Subject to modifications. Please note that some products may not be available in all countries. For more detailed information, please consult with your contact partner or directly with Richard Wolf GmbH.

Hand Instruments

		WL	Product no.		
Knot pusher WL 170 mm	For applying and tightening slip knots in arthroscopically applied sutures	170 mm	89150.3000		
		WL	Product no.		
Suture catcher WL 160mm	Hook eye for suture management	160 mm	89150.3003		
		WL	Product no.		
Distally cutting knife WL 160mm W 4.5mm	For loosening soft tissue from the glenoid edge			160 mm	89160.3001
		160 mm	89160.3015		
		WL	Product no.		
Convex rasp WL 175mm W 4.75mm	For arthroscopic "freshening" of the bone at the glenoid in Bankart and SLAP lesions and of the greater tubercle in reconstruction of the rotator cuff			175 mm	89160.3002
				175 mm	89160.3003
		175 mm	89160.3005		

Sterilization Basket

for Instruments Used in Shoulder Arthroscopy

Sterilization – storage – transport

Illustration	Description	Product no.
 <p>Perf. Basket for shoulder arthroscopy</p> <p>also:</p> <p>Fixing ring Ø 50.39mm</p>	<p>Holds: instrument set for shoulder arthroscopy, for sterilization (steam and low-temperature), storage and transport, with instrument holders, inner dimensions (wxhxd): 513x95x233mm, outer dimensions (wxhxd): 538x117x250mm</p> <p>for perforated basket for flexible endoscopes, for fixing instruments during machine reprocessing, sterilization (steam and low-temperature), storage and transport, Ø 50,39x3,53mm, PACK=10 PCS</p>	<p>33012</p> <p>643301261</p>

Suitable for standard container

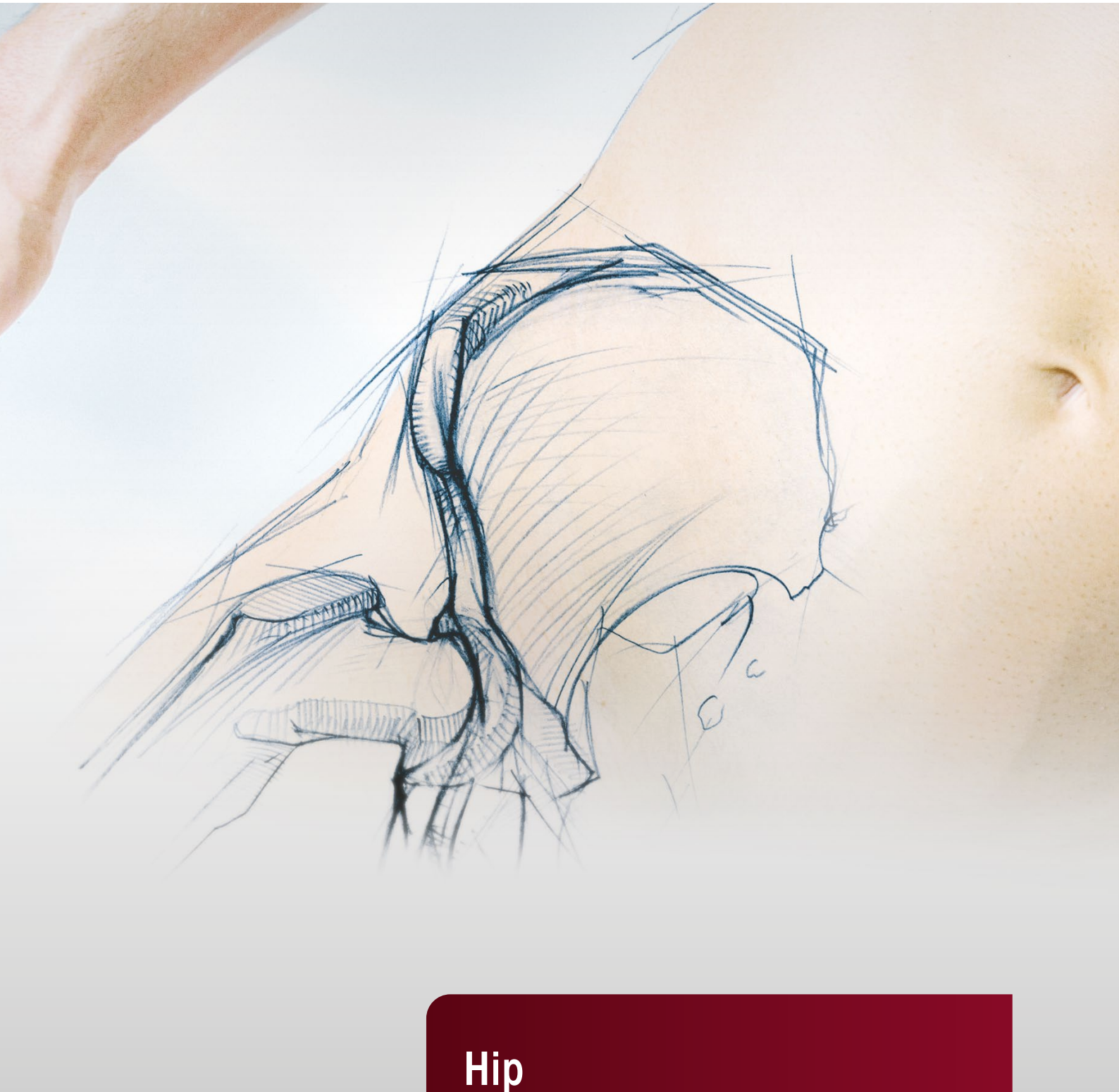

Hip

Hip

3.1

Arthrolution Arthroscopes Overview

3.2

Telescopes and Sheaths

3.3

Access Instruments

3.4

Dilation Systems

3.5

Irrigation Cannula

3.6

Aiming Device

3.7

Instruments

Overview

arthro <i>lution</i>			Fingers, toes	Hand	Foot, elbow		Knee, shoulder, hip
Telescope Ø			1.9 mm	2.4 mm	2.7 mm		4.0 mm
Telescopes	30°	PANOVIEW telescope	8860453	8871413	8476.433	8672.422	8880.543
		PANOVIEW wide angle telescope					8885.443
	70°	PANOVIEW telescope					8880.545
		PANOVIEW wide angle telescope					8885.445
Sheath WL			40 mm	60 mm	77.5 mm	145 mm	130 mm
Sheaths	with 1 irrigation stopcock, fixed		891220124	891220132			
	with 2 irrigation stopcocks, fixed						89121.0260
	with 1 irrigation stopcock, rotatable					891241141	
	with 2 irrigation stopcocks, rotatable			891221232	891221241	891241241	89121.1260
	High-Flow with 1 irrigation stopcock, fixed		891220128				
	High-Flow with 2 irrigation stopcocks, rotatable			891221235			89121.1263
	Small-caliber with 2 irrigation stopcocks, rotatable						891221255
Obturator	blunt				891222754		89121.0544
	semi-blunt		891221952	891222452			89121.0542
	conical blunt				891222750	891242750	89121.0540
	sharp					891242761	89121.0640
	conical pointed		891221962	891222462	891222762		
Sealing part for sheath						891040000	

COXARTIS

Telescope Ø 4 mm
for 4 mm arthroscopes

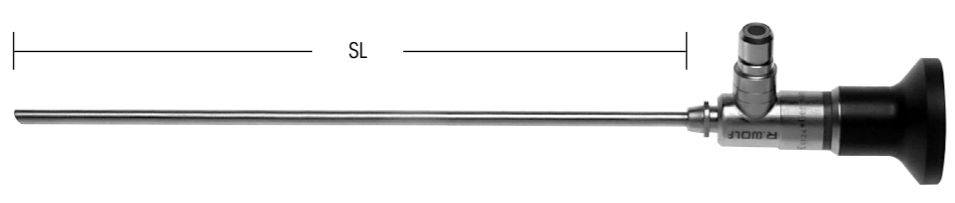

Direction of view		SL	Ø	Product no.
0°	PANOVIEW telescope 0° Ø 4mm SL 170mm	170 mm	4.0 mm	8880.541
30°	PANOVIEW telescope 30° Ø 4mm SL 170mm			8880.543
45°	PANOVIEW telescope 45° Ø 4mm SL 170mm			8880.544
70°	PANOVIEW telescope 70° Ø 4mm SL 171mm	176 mm		8880.547

Recommended accessories		Product no.
Perf. basket for standard telescope 1	(L x B x H) 297 x 59 x 54 mm	38015
Fiber light cable bndl Comprising: Fiber light cable (80663523), adapter projector side (8095.07) and adapter endoscope side (809509)	Ø 3.5 mm, 2.3 m long	806635231

|| Subject to modifications. Please note that some products may not be available in all countries. For more detailed information, please consult with your contact partner or directly with Richard Wolf GmbH.

|| Subject to modifications. Please note that some products may not be available in all countries. For more detailed information, please consult with your contact partner or directly with Richard Wolf GmbH.

COXARTIS

Sheath Ø 4 mm
for 4 mm arthroscopes

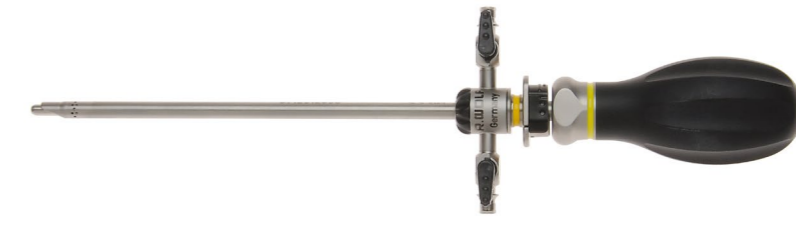

	2 rotatable stopcocks	Outer Ø	WL	Product no.	Obturator for arthroscope OD 6/6.3mm cannulated, capacity 2mm
ArthroLution sheath for arthroscope OD 6mm with automatic click-lock mechanism	●	6.0 mm	145 mm	8912312603	891234073
Also: Sealing part for sheath					89101.0000



For continuous irrigation Comprising:	2 rotatable stopcocks	Outer Ø	WL	Product no.	Obturator for arthroscope OD 5.3/6 mm, semi-blunt, capacity 2mm
ArthroLution sheath for arthroscope OD 5.3mm, with automatic click-lock mechanism		5.3 mm		8912312533	891234052
Outer sheath for arthroscope OD 6.3mm	●	6.3 mm	130 mm	8912300633	
Also: Sealing part for sheath					89101.0000

COXARTIS

Telescope and Sheath Systems
for 4 mm arthroscopes, extra long

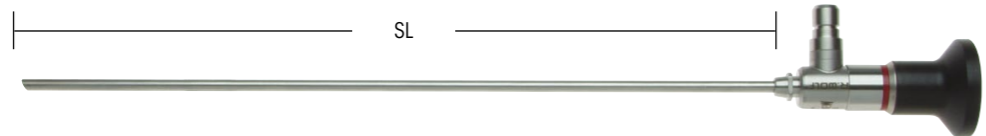

AUTOCLAVE
134° C / 273° F

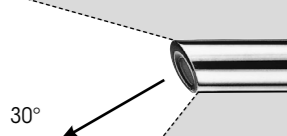
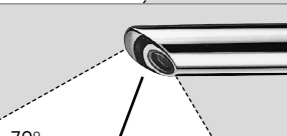
Direction of view		SL	Ø	Product no.
	PANOVIEW telescope 30° Ø 4 mm SL 248 mm	248 mm	4.0 mm	891134030
	PANOVIEW telescope 70° Ø 4 mm SL 251 mm	251 mm		891134070

Recommended accessories		Product no.
Perf. basket for standard telescope 1	(L x B x H) 297 x 59 x 54 mm	38015
Fiber light cable bndl Comprising: Fiber light cable (80663523), adapter projector side (8095.07) and adapter endoscope side (809509)	Ø 3.5 mm, 2.3 m long	806635231



	2 rotatable stopcocks	Outer Ø	WL	Product no.	Obturator for arthroscope OD 6 mm, cannulated, capacity 2 mm
ArthroLution sheath for arthroscope OD 6mm, with automatic click-lock mechanism	●	6.0 mm	145 mm	8912312607	891234077
Also: Sealing part for sheath					89101.0000

|| Subject to modifications. Please note that some products may not be available in all countries. For more detailed information, please consult with your contact partner or directly with Richard Wolf GmbH.

|| Subject to modifications. Please note that some products may not be available in all countries. For more detailed information, please consult with your contact partner or directly with Richard Wolf GmbH.

COXARTIS

Access Instruments
Cannula for punction, guide wire, marking rod



	Ø	Capacity	WL	Product no.
Cannula for punction Ø 2.6/2mm WL 200mm with internal needle, (PACK= 2 PCS)	2.6 mm	2.0 mm	200 mm	891732018



	Ø	TL	Product no.
Nitinol guide wire Ø 2mm (PACK= 2 PCS)	2.0 mm	450 mm	891534020



	Ø	Capacity	TL	Product no.
Marking rod Ø 4.0mm cannulated	4.0 mm	2.25 mm	325 mm	891532040
Marking rod Ø 4.0mm conical blunt	4.0 mm	-	325 mm	8863.75

Hip

4.3

COXARTIS
Access Instruments
Guide tube



	Ø	Capacity	WL	Product no.
Guide sheath slitted WL 120 mm SZ 7 mm slotted	2.6 mm	2 mm	200 mm	891237012
Obturator for guide tube cannulated			142 mm	891232070

|| Subject to modifications. Please note that some products may not be available in all countries. For more detailed information, please consult with your contact partner or directly with Richard Wolf GmbH.

|| Subject to modifications. Please note that some products may not be available in all countries. For more detailed information, please consult with your contact partner or directly with Richard Wolf GmbH.

COXARTIS
Access Instruments
Dilation system



	Color coding	Ø	Capacity	WL	Product no.
Dilatator Ø 5mm WL 200mm cannulated	green	5.0 mm	2.0 mm	200 mm	891532050
Dilatator Ø 7mm WL 200mm cannulated	blue	7.0 mm			891532070
Dilatator Ø 9mm WL 200mm cannulated	red	9.0 mm			891532090
Handle attachment for dilators					891530000

COXARTIS

Irrigation Cannula



	Ø	Capacity	WL	Product no.
Cannula for irrigation Ø 8mm WL 168mm	8 mm	7 mm	168 mm	891737080

VI121 || Subject to modifications. Please note that some products may not be available in all countries. For more detailed information, please consult with your contact partner or directly with Richard Wolf GmbH.

VI121 || Subject to modifications. Please note that some products may not be available in all countries. For more detailed information, please consult with your contact partner or directly with Richard Wolf GmbH.

COXARTIS

Aiming Device





		Product no.
Aiming device bndl Comprising:	Hip alignment ARC (891240100), Hip guide sleeve (891240200), Guide attachment AD hip (891240300), Rotatable irrigation ring hip (891240400)	891240000
Hip alignment ARC with adapter for rotatable irrigation ring		891240100
Hip guide sleeve for connection to puncture cannula 891732018		891240200
Guide attachment AD hip for connection to guide sleeve		891240300
Rotatable irrigation ring hip rotatable with 2 stopcocks and adapter for alignment bracket		891240400

COXARTIS

Hook Probe / Banana Knife



spirit of excellence

			
	Height	WL	Product no.
Hook probe WL 150mm H 4.5mm	4.5 mm	150 mm	891534515
			

		
	WL	Product no.
Banana knife WL 125mm	125 mm	8436.251
		

			
	Width	WL	Product no.
Convex rasp WL 175mm W 4.75mm	4.75 mm	175 mm	89160.3002
			

|| Subject to modifications. Please note that some products may not be available in all countries. For more detailed information, please consult with your contact partner or directly with Richard Wolf GmbH.

|| Subject to modifications. Please note that some products may not be available in all countries. For more detailed information, please consult with your contact partner or directly with Richard Wolf GmbH.

COXARTIS

Curette and Microfractor



spirit of excellence

				
		Ø	WL	Product no.
Curette, square, Ø 4.5mm WL 170mm	double-blade and curved upward	4.5 mm	170 mm	891632245
Curette, square, Ø 5mm WL 170mm		5.0 mm		891632260
Curette, round, Ø 4.8mm WL 170mm		4.8 mm		891631255
Curette, round, Ø 6.3mm WL 170mm		6.3 mm		891631270

			
	Deflection	WL	Product no.
Microfractor WL 170mm 15°	Curved 15°	170 mm	891631521
Microfractor WL 170mm 30°	Curved 30°		891633021
Microfractor WL 170mm 45°	Curved 45°		891634521
Microfractor WL 170 mm 35°	35° S-shaped		891633522
Microfractor WL 170mm 60°	Curved 60°		891636021
Microfractor WL 170mm 60°	60° S-shaped		891636022
Microfractor WL 170mm 80°	Curved 80°		891638021

COXARTIS

PULSEShifter Microfractor /
Grasping Forceps

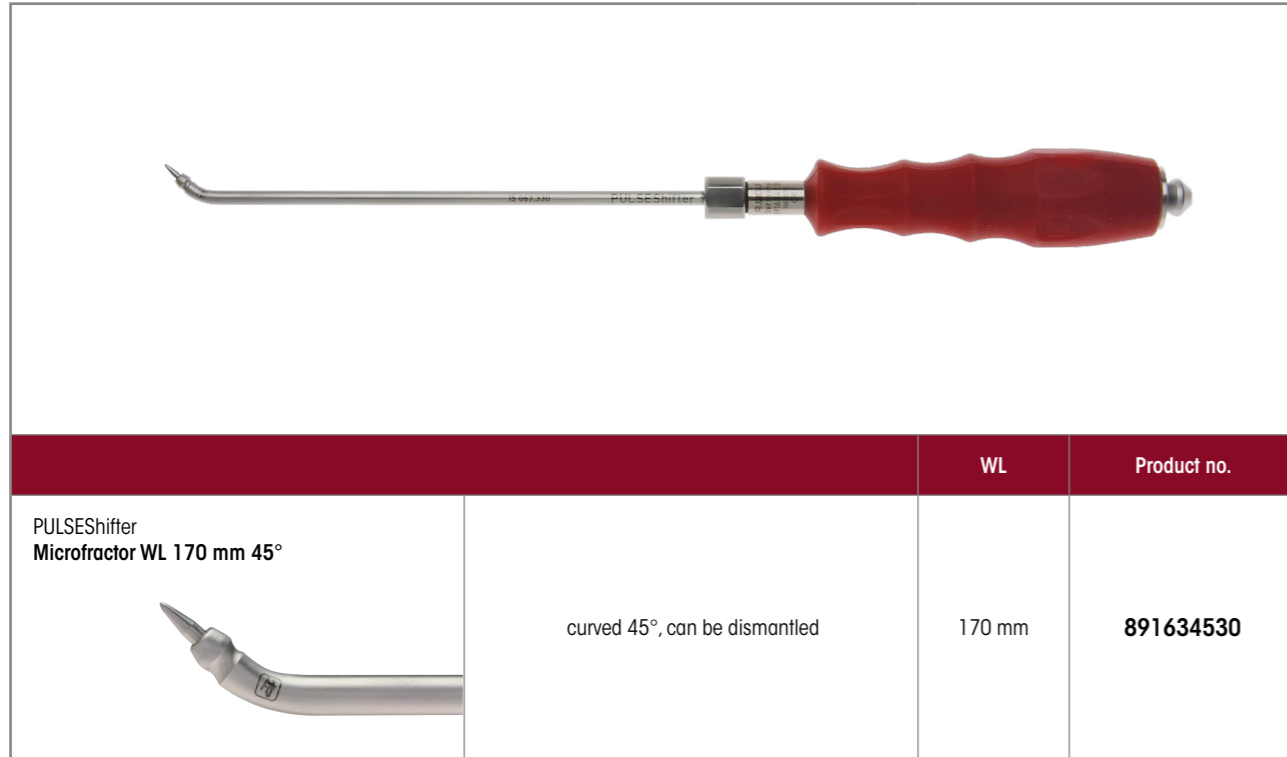

	WL	Product no.
<p>PULSEShifter Microfractor WL 170 mm 45° curved 45°, can be dismantled</p>	170 mm	891634530

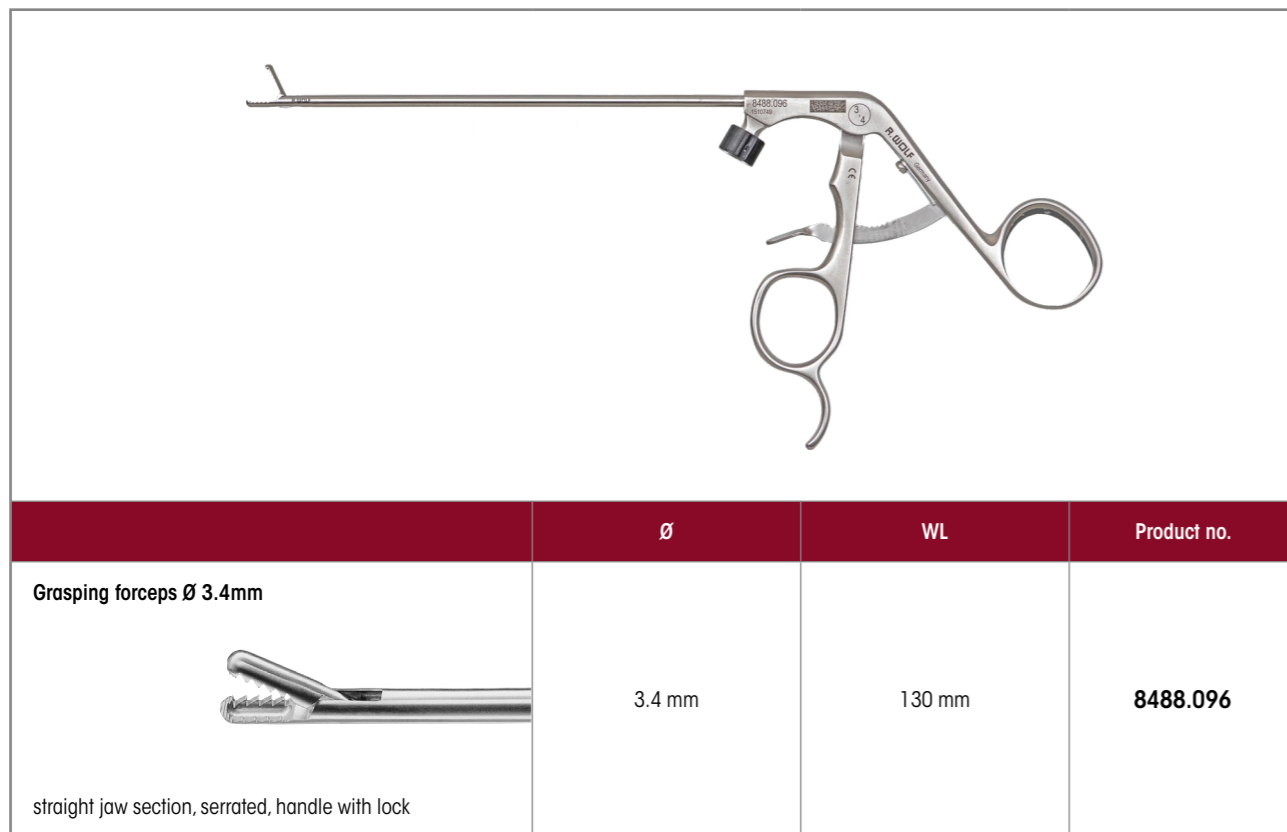

	Ø	WL	Product no.
<p>Grasping forceps Ø 3.4mm straight jaw section, serrated, handle with lock</p>	3.4 mm	130 mm	8488.096

VI121 || Subject to modifications. Please note that some products may not be available in all countries. For more detailed information, please consult with your contact partner or directly with Richard Wolf GmbH.

VI121 || Subject to modifications. Please note that some products may not be available in all countries. For more detailed information, please consult with your contact partner or directly with Richard Wolf GmbH.

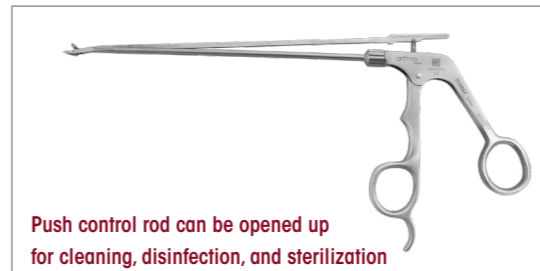
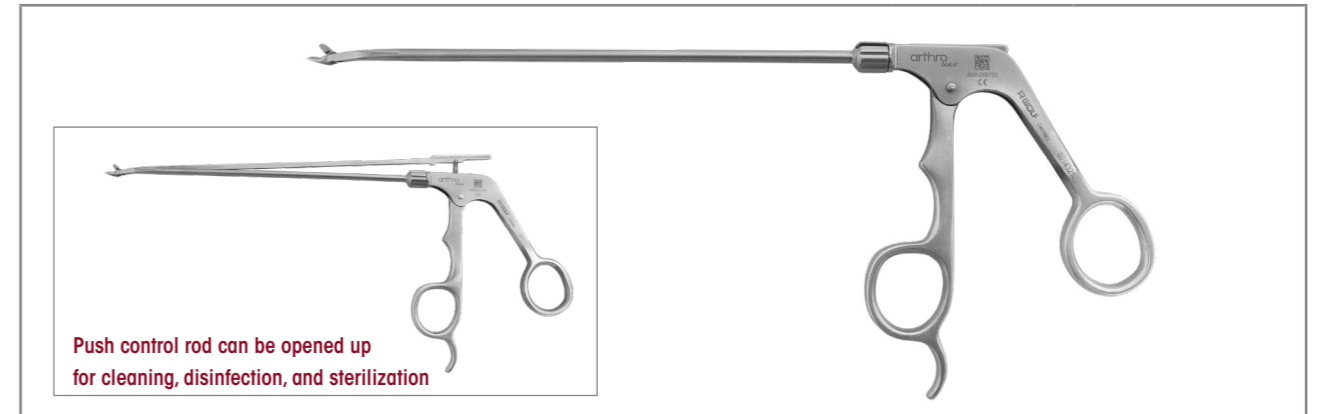

COXARTIS

arthroline Punch



Push control rod can be opened up for cleaning, disinfection, and sterilization

ARTHROline	Jaw section (Height)	WL	Straight	Curved to the left	Curved to the right	Sheath curved upward	Jaws curved upward	Product no.	
<p>Punch WL 180mm H 1.6mm</p> <p>Sectional view: </p>	1.6 mm	180 mm	•				•	891432102	
<p>Punch WL 180mm H 1.6mm</p> <p>Sectional view: </p>				•			•	891432101	
<p>Punch WL 180mm H 1.6mm</p> <p>Sectional view: </p>						•		•	891432103
<p>Punch WL 180mm H 1.6mm</p> <p>Sectional view: </p>							•	•	891432122

Spare part and accessory		Product no.
<p>Sterile adapter eyecup for replacing the endoscope under sterile conditions, locking mechanism</p>		<p>8580.91</p>
<p>Sealing part for sheath</p>		<p>89101.0000</p>
<p>Irrigation ring with 1 stopcock</p>		<p>150081761</p>
<p>Irrigation ring with 2 stopcocks</p>		<p>150081762</p>
<p>Stopcock bndl cap 3.0mm (PACK= 5 PCS)</p>		<p>896.0002</p>
<p>Mounting ring</p>		<p>15008.1704</p>
<p>Spare seal set Comprising: O-ring 9.25X 1.78 VMQ-70 coated (15364396) O-ring 7.65X 1.78 VMQ-70 coated (15364395) (PACK= 5 PCS)</p>		<p>15176.142</p>
<p>Also: O-ring tool</p>		<p>15106.230</p>



Elbow / Foot

Elbow / Foot

4.1

Arthrolution Arthroscopes Overview

4.2

Telescopes and Sheaths

4.3

**Instruments – Drainage Cannulas / Hook Probes / Guide and Marking Rods /
ARTHROline Punches / Scissors / Forceps**

4.4

Instruments for Endoscopically Assisted Decompression of the Ulnar Nerve

Overview

arthro <i>lution</i>			Fingers, toes	Hand	Foot, elbow		Knee, shoulder, hip
Telescope Ø			1.9 mm	2.4 mm	2.7 mm		4.0 mm
Telescopes	30°	PANOVIEW telescope	8860453	8871413	8476.433	8672.422	8880.543
		PANOVIEW wide angle telescope					8885.443
	70°	PANOVIEW telescope					8880.545
		PANOVIEW wide angle telescope					8885.445
Sheath WL			40 mm	60 mm	77.5 mm	145 mm	130 mm
Sheaths	with 1 irrigation stopcock, fixed		891220124	891220132			
	with 2 irrigation stopcocks, fixed						89121.0260
	with 1 irrigation stopcock, rotatable					891241141	
	with 2 irrigation stopcocks, rotatable			891221232	891221241	891241241	89121.1260
	High-Flow with 1 irrigation stopcock, fixed		891220128				
	High-Flow with 2 irrigation stopcocks, rotatable			891221235			89121.1263
	Small-caliber with 2 irrigation stopcocks, rotatable						891221255
Obturator	blunt				891222754		89121.0544
	semi-blunt		891221952	891222452			89121.0542
	conical blunt				891222750	891242750	89121.0540
	sharp					891242761	89121.0640
	conical pointed		891221962	891222462	891222762		
Sealing part for sheath						891040000	

Telescope 2.7 mm
for Standard Arthroscope

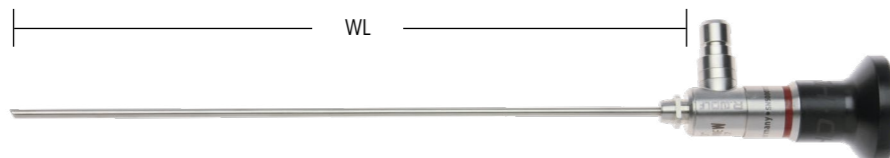

WL

AUTOCLAVE
134° C / 273° F

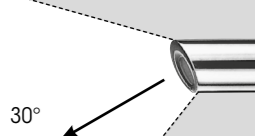
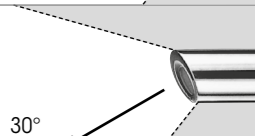
Direction of view		WL	Ø	Product no.
	PANOVIEW PLUS HD telescope 30° Ø 2.7mm WL 103mm	103 mm	2.7 mm	8476.433
	PANOVIEW TELESCOPE 30° Ø 2.7mm WL 182mm	182 mm		8672.422

V1121 || Subject to modifications. Please note that some products may not be available in all countries. For more detailed information, please consult with your contact partner or directly with Richard Wolf GmbH.

Recommended accessories		Product no.
Perf. basket for standard telescope 1	(L x B x H) 297 x 59 x 54 mm	38015
Fiber light cable bndl Comprising: Fiber light cable (80663523), adapter projector side (8095.07) and adapter endoscope side (809509)	Ø 3.5 mm, 2.3 m long	806635231

Telescope 4.0 mm
for Standard Arthroscope

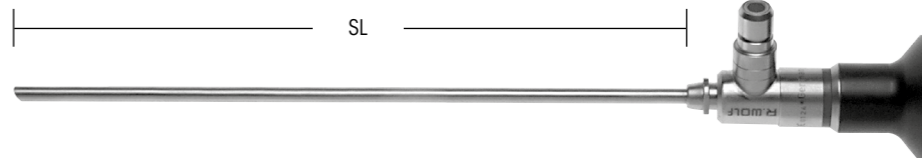

SL

AUTOCLAVE
134° C / 273° F

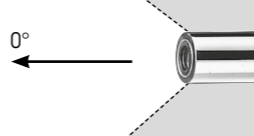
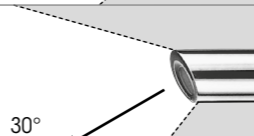
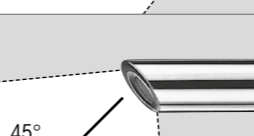
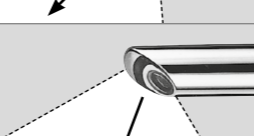
Direction of view		SL	Ø	Product no.
	PANOVIEW telescope 0° Ø 4mm SL 170mm	170 mm	4.0 mm	8880.541
	PANOVIEW telescope 30° Ø 4mm SL 170mm			8880.543
	PANOVIEW telescope 45° Ø 4mm SL 170mm			8880.544
	PANOVIEW telescope 70° Ø 4mm SL 176mm	176 mm		8880.545

V1121 || Subject to modifications. Please note that some products may not be available in all countries. For more detailed information, please consult with your contact partner or directly with Richard Wolf GmbH.

Recommended accessories		Product no.
Perf. basket for standard telescope 1	(L x B x H) 297 x 59 x 54 mm	38015
Fiber light cable bndl Comprising: Fiber light cable (80663523), adapter projector side (8095.07) and adapter endoscope side (809509)	Ø 3.5 mm, 2.3 m long	806635231

arthro Sheath for Arthroscope
lution

with automatic click-lock mechanism

						
Sheath for arthroscope OD 4.1 mm				Obturator for arthroscope OD 4.1 mm blunt	Obturator for arthroscope OD 4.1 mm conical blunt	Obturator for arthroscope OD 4.1 mm conical pointed
2 rotatable stopcocks	Outer Ø	WL	Product no.			
•	4.1 mm	77.5 mm	891221241	891222754	891222750	891222762



|| Subject to modifications. Please note that some products may not be available in all countries. For more detailed information, please consult with your contact partner or directly with Richard Wolf GmbH.

|| Subject to modifications. Please note that some products may not be available in all countries. For more detailed information, please consult with your contact partner or directly with Richard Wolf GmbH.

Recommended accessories		Product no.
Sealing part for sheath		89101.0000
Marking rod Ø 4.0 mm, TL 325 mm	conical blunt	8863.75
Spare parts		
Irrigation ring with 1 stopcock		150081761
Irrigation ring with 2 stopcocks		150081762
Stopcock bndl cap 3.0mm (PACK= 5 PCS)		896.0002
Also: Disassembly tool		38310.0001
Mounting ring		15008.1704
Spare seal set (O-rings)	Comprising: O-ring, small (PACK= 5 PCS) O-ring, large (PACK= 5 PCS)	15176.142
Also: O-ring tool (disassembly tool)		15106.230

arthro Sheath for Arthroscope
lution

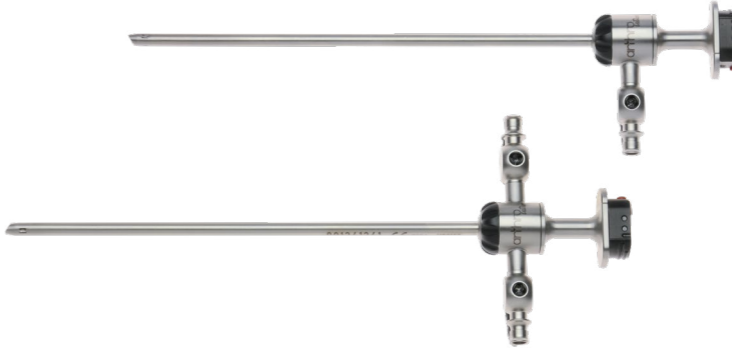
with automatic click-lock mechanism

						
Sheath for arthroscope OD 4.1 mm					Obturator for arthroscope OD 4.1 mm sharp, with slanted tip	Obturator for arthroscope OD 4.1 mm conical blunt
1 rotatable stopcock	2 rotatable stopcocks	Outer Ø	WL	Product no.		
•		4.1 mm	145 mm	891241141	891242761	891242750
	•			891241241		

Recommended accessories		Product no.
Sealing part for sheath		891040000
Marking rod Ø 2.7 mm, TL 250 mm	conical pointed	891242725
Spare parts		
Irrigation ring with 1 stopcock		150081761
Irrigation ring with 2 stopcocks		150081762
Stopcock bndl cap 3.0mm (PACK= 5 PCS)		896.0002
Also: Disassembly tool		38310.0001
Mounting ring		15008.1704
Spare seal set (O-rings)	Comprising: O-ring, small (PACK= 5 PCS) O-ring, large (PACK= 5 PCS)	15176.142
Also: O-ring tool (disassembly tool)		15106.230

Drainage Cannula Ø 2.3 mm / 3.7 mm

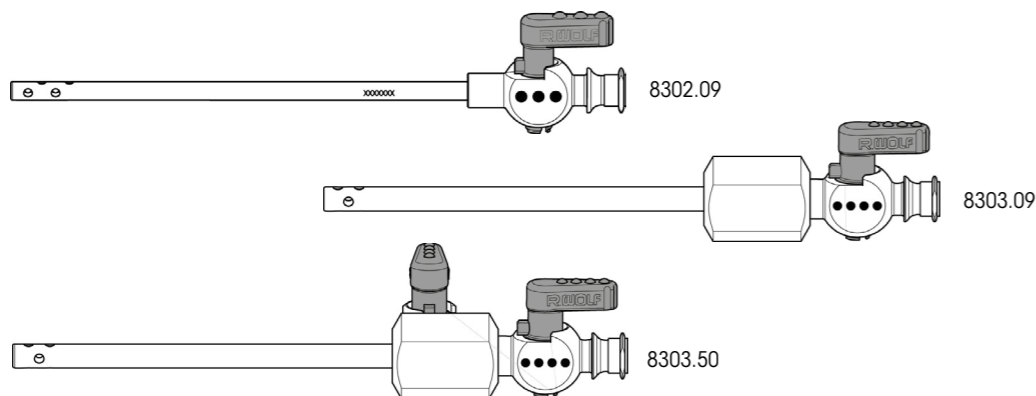

Drainage for cannula and obturator	Capacity	Ø	WL	Product no.
Drainage for cannula Ø 3.2mm WL 80mm with 1 insufflation stopcock	2.3 mm	3.2 mm	80 mm	8302.09
Drainage for cannula Ø 4.5mm WL 71.5mm with 1 insufflation stopcock	3.7 mm	4.5 mm	71.5 mm	8303.09
Drainage for cannula Ø 4.5mm WL 71.5mm with 2 insufflation stopcocks	3.7 mm	4.5 mm	71.5 mm	8303.50
Obturator for cannula OD 3.2mm sharp, with slanted tip		2.3 mm	103 mm	8302.101
Obturator for cannula OD 3.2mm conical blunt tip		2.3 mm	103 mm	8302.11
Obturator for cannula OD 4.5mm sharp, with pyramid-shaped tip		3.7 mm	115 mm	8303.10
Obturator for cannula OD 4.4mm conical blunt tip		3.7 mm	115 mm	8303.11
Also:				
Silicone tube with Luer fitting 886.00	for Drainage for cannula 8302.09		Length 2.0 m	8302.90
Silicone tube with Luer fitting 886.01	for Drainage for cannula 8303.09 / .50			8303.90

|| Subject to modifications. Please note that some products may not be available in all countries. For more detailed information, please consult with your contact partner or directly with Richard Wolf GmbH.

|| Subject to modifications. Please note that some products may not be available in all countries. For more detailed information, please consult with your contact partner or directly with Richard Wolf GmbH.

Hook Probe / Marking Rod

	H	WL	Product no.
Hook probe WL 115mm H 7mm, graduated	7.0 mm	115 mm	8399.901
Hook probe WL 115mm H 4.5mm, graduated	4.5 mm		8399.95

	Ø	TL	Product no.
Hook probe TL 228 mm SZ 4.4mm	4.4 mm	228 mm	8863.80

	8863.75		
	891242725		

	Ø	TL	Product no.
Marking rod Ø 4.0mm conical blunt	4.0 mm	325 mm	8863.75
Marking rod Ø 2.7mm conical pointed	2.7 mm	250 mm	891242725

arthroline Punch



Push control rod can be opened up for cleaning, disinfection, and sterilization

ARTHROline	Jaw section (Height x width)	Cut width	WL	Straight	Curved to the right	Curved to the left	Sheath curved upward	Jaw section curved upward	Product no.	
Punch W 4.6mm H 1.6mm movable jaw section serrated Sectional view:	1.6 x 4.6 mm	3.3 mm	120 mm	•					89140.0105	
Punch W 4.6mm H 1.6mm movable jaw section serrated Sectional view:				•					89140.0102	
Punch W 4. mm H 1.6mm movable jaw section serrated Sectional view:						•			89140.0122	
Punch W 5.5mm H 1.6mm movable jaw section serrated Sectional view:								•	•	89140.0101
Punch W 5.5mm H 1.6mm movable jaw section serrated Sectional view:				1.6 x 5.5 mm						•

VI121 || Subject to modifications. Please note that some products may not be available in all countries. For more detailed information, please consult with your contact partner or directly with Richard Wolf GmbH.

VI121 || Subject to modifications. Please note that some products may not be available in all countries. For more detailed information, please consult with your contact partner or directly with Richard Wolf GmbH.

arthroline Hook Punch / Basket Punch



Push control rod can be opened up for cleaning, disinfection, and sterilization

ARTHROline	Jaw section (Height x width)	Cut width	WL	Straight	Jaw section curved upward	Product no.
Hook punch W 3mm H 1.6mm Sectional view:	1.6 x 3.0 mm	1.8 mm	120 mm	•		89140.0205
Hook punch W 3mm H 1.6mm Sectional view:					•	89140.0202
Basket punch W 6.5mm H 2.1mm oval Sectional view:	2.1 x 6.5 mm	4.5 mm		•		89140.0305
Basket punch W 6.5mm H 2.1mm oval Sectional view:						•
Hook punch W 4mm H 2.1mm Sectional view:	2.1 x 4.0 mm	2.1 mm		•		89140.0405
Hook punch W 4 m H 2.1mm Sectional view:						

VI121 || Subject to modifications. Please note that some products may not be available in all countries. For more detailed information, please consult with your contact partner or directly with Richard Wolf GmbH.

VI121 || Subject to modifications. Please note that some products may not be available in all countries. For more detailed information, please consult with your contact partner or directly with Richard Wolf GmbH.

arthroline Punch / Scissors Punch

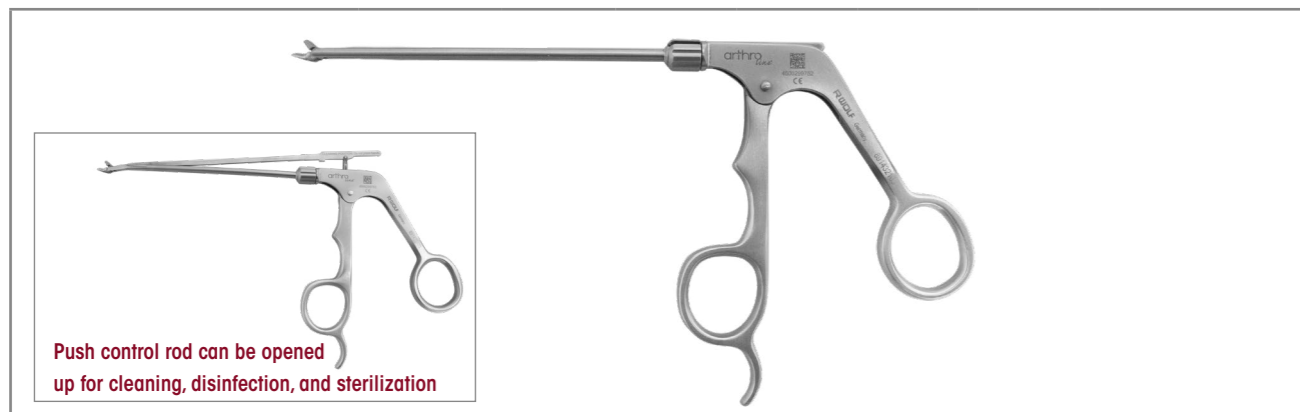

ARTHROline	Jaw section (Height x width)	Cut width	WL	Straight	Retrograde cutting	Jaw section curved upward	Product no.
Scissors punch W 2.4mm H 2.1mm	2.1 x 2.4 mm	0.9 mm	120 mm	•			89140.0505
Sectional view:							
Scissors punch W 2.4mm H 2.1mm						•	89140.0502
Sectional view:							
Punch W 5.7mm H 4mm retrograde left-cutting	4.0 x 5.7 mm	2.3 mm		•	left		89140.0605
Sectional view:							
Punch W 5.7mm H 4mm retrograde right-cutting				•	right		89140.0602
Sectional view:							

VI121 || Subject to modifications. Please note that some products may not be available in all countries. For more detailed information, please consult with your contact partner or directly with Richard Wolf GmbH.

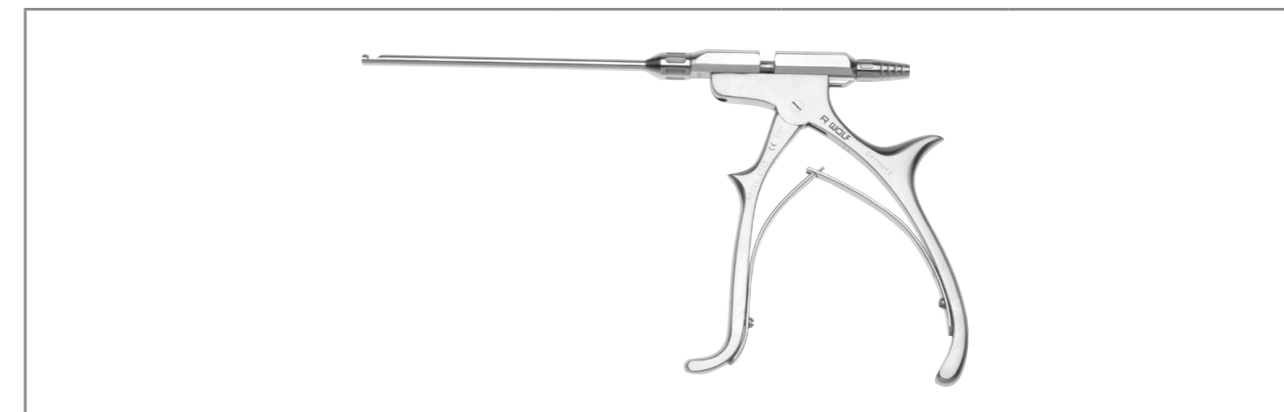

VI121 || Subject to modifications. Please note that some products may not be available in all countries. For more detailed information, please consult with your contact partner or directly with Richard Wolf GmbH.

Suction Punch with Integrated Suction Channel



	Ø	WL	Product no.
Suction punch Ø 2.7 mm with integrated suction channel	2.7 mm	110 mm	89140.0027

Grasping Forceps / Miniature Forceps





			
	Ø	WL	Product no.
Grasping forceps Ø 3.4mm straight jaw section, serrated, handle with lock	3.4 mm	130 mm	8488.096
			

			
With overload protection and irrigation connector	Sheath Ø	WL	Product no.
Miniature forceps Ø 2.7mm with double spoon jaw	2.7 mm	110 mm	8486.614
Miniature grasping forceps Ø 2.7mm			8486.624
Hook punch Ø 2.7mm			8486.604

VI121 || Subject to modifications. Please note that some products may not be available in all countries. For more detailed information, please consult with your contact partner or directly with Richard Wolf GmbH.

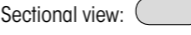

VI121 || Subject to modifications. Please note that some products may not be available in all countries. For more detailed information, please consult with your contact partner or directly with Richard Wolf GmbH.

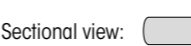
Hook Punch / Punch

													
	Sheath Ø	WL	Jaw section (Height x width)	Cut width	Straight	Curved to the left	Curved to the right	Sheath curved 15° upward	Jaw section curved 15° upward	Product no.			
Hook punch Ø 3.4mm with shovel	3.4 mm	130 mm	3,4 x 3,4 mm	1,6 mm	•					8488.951			
						•						8488.952	
							•						8488.953
Sectional view: 											•		8488.954
Hook punch Ø 3.4mm movable jaw section serrated	3.4 mm	130 mm	3,4 x 3,4 mm	1,6 mm	•					8488.02			
											•	8488.025	
Hook punch Ø 3.4mm serrated	3.4 mm	130 mm	1,93 x 3,9 mm	2,7 mm	•					8488.121			
											•	8488.063	
Hook punch Ø 4.5mm with shovel, serrated	4.5 mm	130 mm	1,73 x 5,4 mm	3,4 mm					•	8489.063			
Sectional view: 													

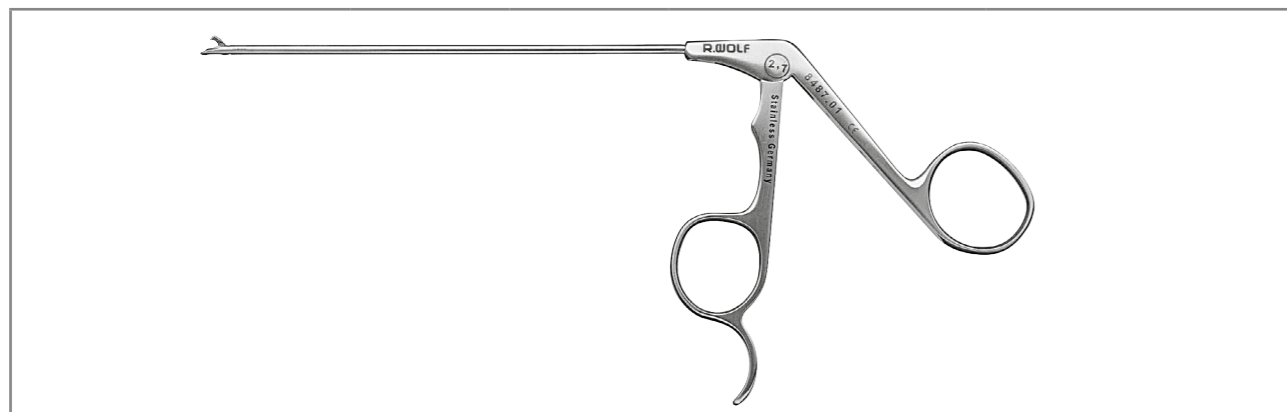
Punch / Double Spoon Forceps



	Jaw section (Height x width)	Deflection	Cut width	WL	Product no.
Punch Ø 3.4mm front- and side-cutting  Sectional view: <input type="checkbox"/>	2.2 x 5.3 mm	90° left	3.4 mm	130 mm	8404.017
		90° right			8404.018
Hook punch with shovel Ø 3.4mm  Sectional view: <input type="checkbox"/>	2.1 x 2.0 mm	45° left	1.7 mm		8404.71*
		45° right			8404.81*

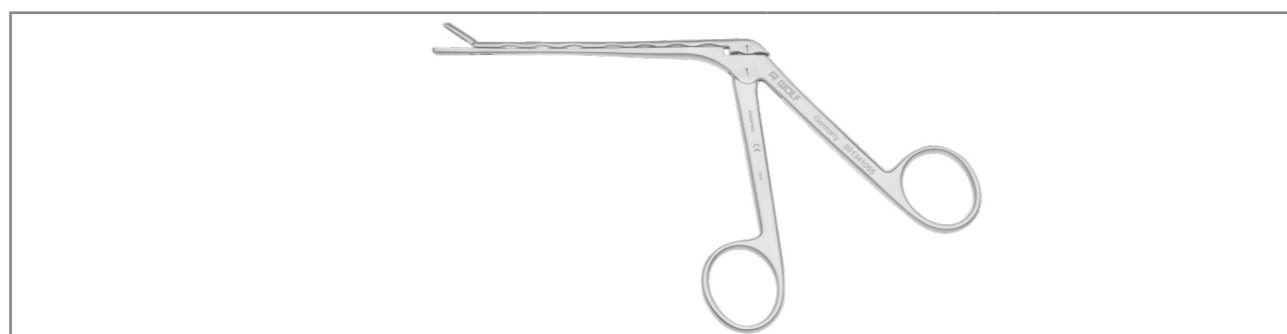

* particularly suitable for lateral cutting and smoothing

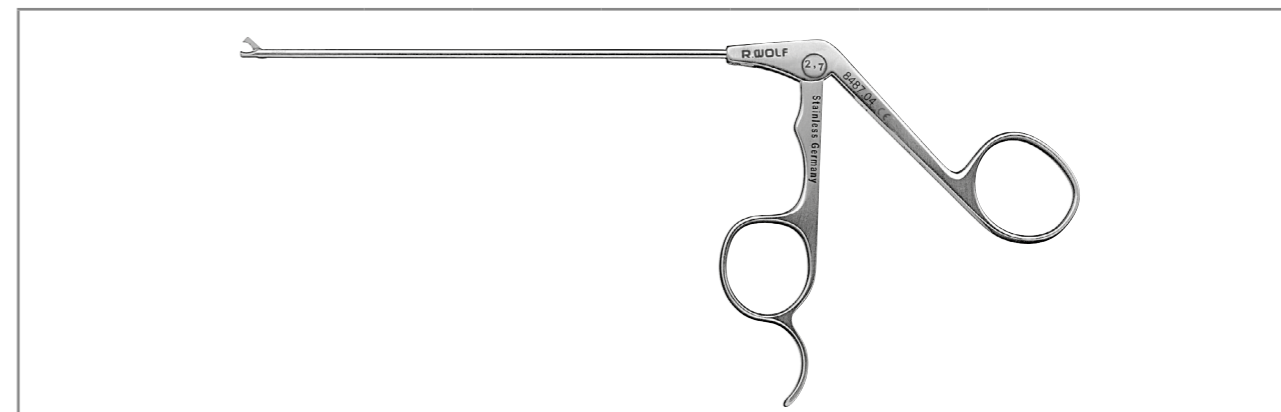

	Jaw section (Height x width)	WL	Product no.
Double spoon forceps W 3.1mm H 4.6mm wave-shaped sheath 	4.6 x 3.1 mm	105 mm	891341055

Hook Scissors



	WL	Straight jaw section	Straight sheath	Sheath curved to the left	Sheath curved to the right	Product no.
Hook scissors Ø 3.4mm  Sectional view: <input type="checkbox"/>	130 mm	<input type="checkbox"/>	<input type="checkbox"/>	<input type="checkbox"/>	<input type="checkbox"/>	8488.04
		<input type="checkbox"/>	<input type="checkbox"/>	<input checked="" type="checkbox"/>	<input type="checkbox"/>	8488.041
<input type="checkbox"/>		<input type="checkbox"/>	<input type="checkbox"/>	<input checked="" type="checkbox"/>	<input type="checkbox"/>	8488.042
<input type="checkbox"/>		<input type="checkbox"/>	<input type="checkbox"/>	<input type="checkbox"/>	<input checked="" type="checkbox"/>	8488.053
	WL	Jaw section deflection	Straight sheath		Product no.	
	130 mm	45° right	<input checked="" type="checkbox"/>		8404.62	

VI121 || Subject to modifications. Please note that some products may not be available in all countries. For more detailed information, please consult with your contact partner or directly with Richard Wolf GmbH.

VI121 || Subject to modifications. Please note that some products may not be available in all countries. For more detailed information, please consult with your contact partner or directly with Richard Wolf GmbH.

Hand Instruments
Curette / Microfractor

Elbow / Foot

4.3



	Inner-Ø	WL	Product no.
Curette round Ø 3mm WL 65mm one side sharp, curved upward, cutting on traction	3,0 mm	65 mm	891641140
Curette round Ø 4,5mm WL 65mm both sides sharp, angled and curved upwards	4,5 mm		891641155



	Deflection	WL	Product no.
Microfractor WL 65mm 30°	Curved 30°	65 mm	891643011
Microfractor WL 65mm 45°	Curved 45°		891644511
Microfractor WL 65mm 60°	Curved 60°		891646011

|| Subject to modifications. Please note that some products may not be available in all countries. For more detailed information, please consult with your contact partner or directly with Richard Wolf GmbH.

|| Subject to modifications. Please note that some products may not be available in all countries. For more detailed information, please consult with your contact partner or directly with Richard Wolf GmbH.

Instruments for
Endoscopically Assisted Decompression of the Ulnar Nerve
Optical dissector / telescope

Elbow / Foot

4.4



	WL	Product no.
Opt. dissector WL 158mm graduated	158 mm	891607001

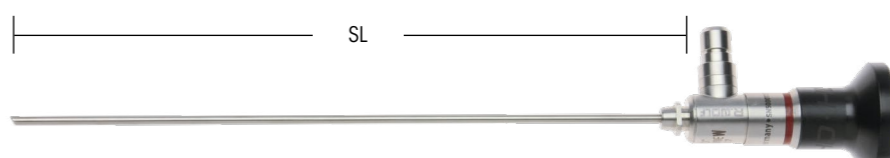

AUTOCLAVE
134° C / 273° F

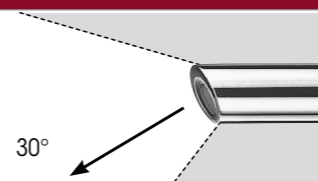
Direction of view		SL	Ø	Product no.
 30°	PANOVIEW telescope 30° Ø 4mm SL 170mm	170 mm	4.0 mm	8880.543

Recommended accessories		Product no.
Perf. basket for standard telescope 1	(L x B x H) 297 x 59 x 54 mm	38015
Fiber light cable bndl Comprising: Fiber light cable (80663523), adapter projector side (8095.07) and adapter endoscope side (809509)	Ø 3.5 mm, 2.3 m long	806635231

Instruments for Endoscopically Assisted Decompression of the Ulnar Nerve

Speculum



	WL	Product no.
Speculum w. Removable light rod WL 55 mm comprising: Speculum WL 55mm (8916070021) and light rod (8916070022)	55 mm	891607002



Hand / Fingers / Toes

Hand / Fingers / Toes

5.1

Arthrolution Arthroscopes Overview

5.2

Telescopes and Sheaths

5.3

Punches / Forceps / Instruments for Small Joints

5.4

ENDO-CARTRIS – Instruments for Carpal Tunnel Release

Overview

arthro <i>lution</i>			Fingers, toes	Hand	Foot, elbow		Knee, shoulder, hip
Telescope Ø			1.9 mm	2.4 mm	2.7 mm		4.0 mm
Telescopes	30°	PANOVIEW telescope	8860453	8871413	8476.433	8672.422	8880.543
		PANOVIEW wide angle telescope					8885.443
	70°	PANOVIEW telescope					8880.545
		PANOVIEW wide angle telescope					8885.445
Sheath WL			40 mm	60 mm	77.5 mm	145 mm	130 mm
Sheaths	with 1 irrigation stopcock, fixed		891220124	891220132			
	with 2 irrigation stopcocks, fixed						89121.0260
	with 1 irrigation stopcock, rotatable					891241141	
	with 2 irrigation stopcocks, rotatable			891221232	891221241	891241241	89121.1260
	High-Flow with 1 irrigation stopcock, fixed		891220128				
	High-Flow with 2 irrigation stopcocks, rotatable			891221235			89121.1263
	Small-caliber with 2 irrigation stopcocks, rotatable						891221255
Obturator	blunt				891222754		89121.0544
	semi-blunt		891221952	891222452			89121.0542
	conical blunt				891222750	891242750	89121.0540
	sharp					891242761	89121.0640
	conical pointed		891221962	891222462	891222762		
Sealing part for sheath						891040000	

Telescope 1.9 mm / 2.4 mm
for Standard Arthroscope



AUTOCLAVE
134° C / 273° F

Direction of view		SL	Ø	Product no.
	PANOVIEW telescope 30° Ø 1.9mm SL 61mm	61 mm	1.9 mm	8860453
	PANOVIEW telescope Ø 2.4mm SL 98mm	98 mm	2.4 mm	8871413

Recommended accessories		Product no.
Perf. basket for standard telescope 1	(L x B x H) 297 x 59 x 54 mm	38015
Fiber light cable bndl Comprising: Fiber light cable (80663523), adapter projector side (8095.07) and adapter endoscope side (809509)	Ø 3.5 mm, 2.3 m long	806635231

|| Subject to modifications. Please note that some products may not be available in all countries. For more detailed information, please consult with your contact partner or directly with Richard Wolf GmbH.

|| Subject to modifications. Please note that some products may not be available in all countries. For more detailed information, please consult with your contact partner or directly with Richard Wolf GmbH.

arthro *lution* heath for Arthroscope

with automatic click-lock mechanism



Sheath for arthroscope OD 2.4 mm (telescope Ø 8860453)					Obturator for arthroscope OD 2.4/2.8 mm semi-blunt	Obturator for arthroscope OD 2.4/2.8 mm conical pointed
High-Flow	1 fixed stopcock	Outer Ø	WL	Product no.		
	•	2.4 mm	40 mm	891220124	891221952	891221962
•	•	2.8 mm		891220128		

Spare parts	Product no.
Irrigation ring with 1 stopcock	150081761
Stopcock bndl cap 3.0mm (PACK= 5 PCS)	896.0002
Also: Disassembly tool	38310.0001
Mounting ring	15008.1704
Spare seal set (O-rings)	Comprising: O-ring, small (PACK= 5 PCS) O-ring, large (PACK= 5 PCS) 15176.142
Also: Disassembly tool	15106.230

arthro_{lution} Sheath for Arthroscope

with automatic click-lock mechanism

Sheath for arthroscope OD 3.2 / 3.5 mm (telescope Ø 8871413)						Obturator for arthroscope OD 3.2/3.5 mm semi-blunt	Obturator for arthroscope OD 3.2/3.5 mm conical pointed		
High-Flow	1 fixed stopcock	2 rotatable stopcocks	Outer Ø	WL	Product no.				
	•		3.2 mm	60 mm	891220132				
		•			891221232	891222452	891222462		
•		•	3.5 mm		891221235				

Spare parts	Product no.
Irrigation ring with 1 stopcock	150081761
Irrigation ring with 2 stopcocks	150081762
Stopcock bndl cap 3.0mm (PACK= 5 PCS)	896.0002
Also: Disassembly tool	38310.0001
Mounting ring	15008.1704
Spare seal set (O-rings)	Comprising: O-ring, small (PACK= 5 PCS) O-ring, large (PACK= 5 PCS) 15176.142
Also: Disassembly tool	15106.230

VI121 || Subject to modifications. Please note that some products may not be available in all countries. For more detailed information, please consult with your contact partner or directly with Richard Wolf GmbH.





VI121 || Subject to modifications. Please note that some products may not be available in all countries. For more detailed information, please consult with your contact partner or directly with Richard Wolf GmbH.

Miniature Punch / Forceps

	Ø	WL	Product no.
Hook punch Ø 2 mm	2.0 mm	65 mm	8486.601
Miniature punch Ø 2.2 mm	2.2 mm	75 mm	8486.602
Miniature forceps Ø 2 mm with double spoon jaw	2.0 mm	60 mm	8486.611
Miniature grasping forceps Ø 2 mm	2.0 mm	60 mm	8486.621

With overload protection and irrigation connector	Sheath Ø	WL	Product no.
Miniature forceps Ø 2.7mm with double spoon jaw	2.7 mm	110 mm	8486.614
Miniature grasping forceps Ø 2.7mm			8486.624
Hook punch Ø 2.7mm			8486.604

Instruments for Small Joints

			
	Ø	WL	Product no.
Spoon Ø 2.4x1 mm WL 100mm 	2.4 x 1 mm	100 mm	8871.562
Curette round Ø 1.45mm WL 100mm 	1.45 mm		8871.571
Knife with handle WL 100mm 	--		8871.586
Hook probe WL 100mm H2mm H = 2.0 mm 	--		8871.721



FLUID CONTROL
Irrigation and Suction Pumps

FLUID CONTROL Irrigation and Suction Pump

6.1

FLUID CONTROL Arthro 2204

FLUID CONTROL Arthro 2204

Suction and irrigation pump for arthroscopy with automatic tube recognition



FLUID CONTROL Arthro

is a new pump system for arthroscopy and fully endoscopic spinal surgery. The particular strength of this system lies in a practical combination of high performance and a cost-effective overall concept. The new software and technical enhancements make the **FLUID CONTROL Arthro** ideal for diagnostic and therapeutic arthroscopies.

FLUID CONTROL Arthro has already been prepared for integration in core, the digital OR from Richard Wolf.

FLUID CONTROL Arthro 2204

Suction and irrigation pump for arthroscopy with automatic tube recognition

**Arthro/spine suc./irrig.pump bndl**

for arthroscopy **22040011**

Comprising:

1 x arthro/spine suc./irrig.pump 200mmHG.....	2204001
1 x irrigation tube set spike	8171223
1 x tube set for vacuum, incl. filter	2206207
1 x protection filter for gas filtration	4171.121
1 x power cable	2440.03

Arthro/spine suc./irrig.pump bndl

with Spine Mode software module for arthroscopy and fully endoscopic spinal surgery **22040012**

Comprising:

1 x arthro/spine suc./irrig.pump 200mmHG	2204001
1 x Spine mode software module	2204101
1 x irrigation tube set spike	8171223
1 x tube set for vacuum, incl. filter	2206207
1 x protection filter for gas filtration	4171.121
1 x power cable	2440.03

Recommended accessories		Product no.
Footswitch		2204901

V1/21 || Subject to modifications. Please note that some products may not be available in all countries. For more detailed information, please consult with your contact partner or directly with Richard Wolf GmbH.

V1/21 || Subject to modifications. Please note that some products may not be available in all countries. For more detailed information, please consult with your contact partner or directly with Richard Wolf GmbH.

FLUID CONTROL Arthro 2204

Irrigation and suction pump for arthroscopy with automatic tube recognition

Day-patient tube set

From two interventions/patients per day:

Use the **day-patient tube set**, which comprises a day tube and a connected patient tube. The day tube remains in the pump throughout the day, while the patient tube has to be changed for each operation. The irrigation fluid bag can remain on the pump until it has been completely

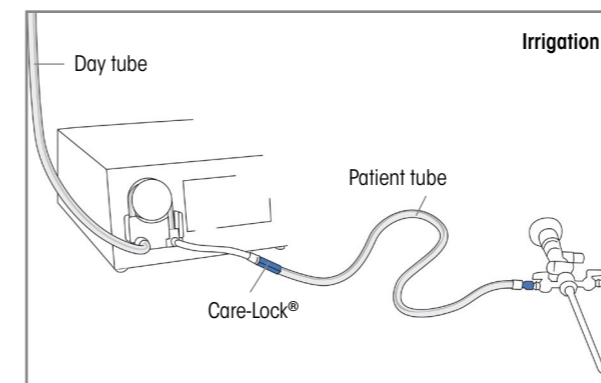

used up. **This significantly reduces the amount of waste and cuts costs.**

Further tube versions are available to complement the system.

Note: The use of the day-patient tube set has not been approved for the Spine Mode application.

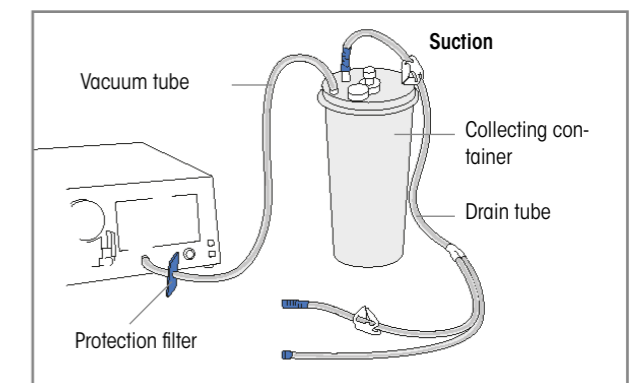

Irrigation			Product no.
Accessories – reusable	Irrigation tube set spike	With Luer-Lock connection, autoclavable, incl. 10 spare membranes, reusable for 20 reprocessing cycles	8171223
Accessories – disposable	Irrigation tube set with spike L 3 m	(PACK= 10 PCS), with Luer-Lock connection, sterile, disposable product	4171223
	Irrigation tube set CARE-LOCK, L 3 m	(PACK= 10 PCS), sterile, disposable product	4171224
	Day irrigation tube set	(PACK= 10 PCS), with piercing spike, sterile disposable product, PVC	4171226
	Patient irrigation tube set L 3m	(PACK= 10 PCS), with Luer-Lock connection, sterile, disposable product, PVC	4171227
<i>Note: Day tube and patient tube can only be used together. A new patient tube is required for each patient – the day tube can be used for up to 20 patients.</i>			

Suction			Product no.
Accessories – reusable	Tube set for vacuum, incl. filter	with integrated hygiene filter, PACK= 10 PCS, service life of 30 days (connected to irrigation pump)	2206207
Accessories – disposable	Secretion container, 2 L	2 liters, no lid	8170.6551
	Secretion container, 2.5 L	2.5 liters	41706566
	Tube set for suction (with 2 ports)	sterile, disposable, (PACK= 10 PCS) for connecting instruments to collecting container	T0503-01

Technical Data

FLUID CONTROL Arthro 2204

Arthro/spine suc./irrig.pump 200mmHG	2204001
Power supply connection	100–240 VAC, 50/60 Hz
Power consumption	118 VA
Protection class to VDE 0750 / IEC 601	1
Classification	CF
Pressure range (infinite preselection)	15–200 mmHg
Delivery rate (can be preselected in 50 ml increments)	0–2 l/min
Dimensions (W x H x D)	300 x 157 x 436 mm
Weight	8.3 kg
Interfaces	USB / CAN bus (core) service interface



Universal Motor Systems

Universal Motor Systems

7.1 **PowerSpeed AS1** Universal Motor System

7.2 **Power Stick M5/3 and M5/0** Motor Handpieces for PowerSpeed AS1

7.3 **Reusable Shaver Blades and Burrs**
for Power Stick M5/3, Power Stick M5/0, and Micro Stick S1

7.4 **Disposable Shaver Blades and Burrs**
for Power Stick M5/3, Power Stick M5/0, and Micro Stick S1

PowerSpeed AS1

Universal motor system



The PowerSpeed AS1 motor system has been developed for universal use and provides extremely comfortable and ergonomic handling.

Quick and powerful resecting, drilling, burring, or sawing – anything is possible.

- Wide range of disposable and reusable shaver blades and burrs
- Intelligent tool detection via RFID chip
- Touchscreen makes user interface easy to operate
- Communication interface with FLUID CONTROL ArthroPump 2204 and **core nova**
- Universal use of all current Richard Wolf motor handpieces
- Wireless footswitch
- Universal use in spinal surgery, bronchoscopy, and arthroscopy

PowerSpeed AS1

Universal motor system



MOTOR CONTROL UNIT 2305

Power supply connection 50/60 Hz, 100–240 V includes power supply cable,

CAN bus connection cable, and packaging **2305001**

Universal motor system for orthopedics and spinal surgery, for connecting motor handpieces when working with shaver and high-speed applications, and for connecting the Power Drill M1.

Recommended accessories	Product no.
Remote footswitch 2 pedals+2 buttons	 2305100
Also:	
Power supply unit 6600403	FW8002M/08
Backup cable, WL 3m	2305300

MOTOR CONTROL UNIT 2305	2305001
Power supply connection	100–240 VAC, 50/60 Hz
Power consumption	250 VA
Electromagnetic compatibility EMC to	IEC / EN 60601-1-2
Medical Devices Directive 93/42/EEC	Class IIa
Protection class to IEC / EN 60601-1 (ANSI / AAMI ES60601-1 / CAN CSA-C22.2 No. 60601-1)	I
Protection against electric shock	Type BF applied part
Degree of protection against the ingress of liquids	IP 20 (not protected)
Operating mode	Continuous operation
Degree of protection in the presence of flammable mixtures	Device is not protected against explosions (do not operate device in areas where there is a danger of explosion)
Weight	9.2 kg
Dimensions (W x H x D)	300 x 159.5 x 404 mm

Power Stick M5/3

Power Stick M5/0

Motor Handpieces for PowerSpeed AS1

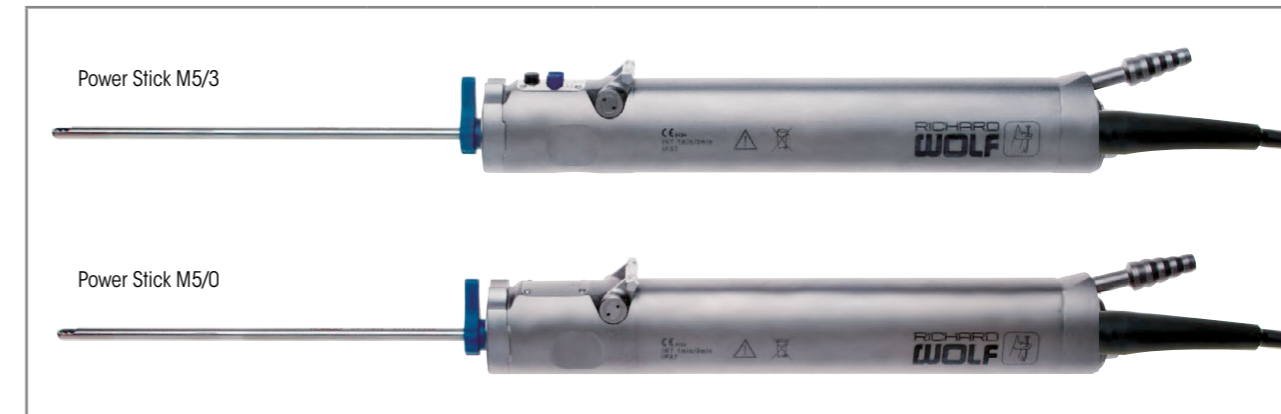

For driving rotation tools with three function buttons			Ø for shaver tools	Product no.
Power Stick M5/3 Motor handpiece max. 16000 rpm	with fixed connection cable, 3.0 m	Operated via button cluster and footswitch	2–6.5 mm	8995500031
	with removable connection cable, 3.0 m			89955.0003
For driving rotation tools			Ø for shaver tools	Product no.
Power Stick M5/0 Motor handpiece max. 16000 rpm	with fixed connection cable, 3.0 m	Operated via footswitch	2–6.5 mm	8995500001
	with removable connection cable, 3.0 m			89955.0000

- Handpieces with/without control panel
- Up to 16,000 rpm
- For tools with a diameter of 2.5–6.5 mm
- Oscillation frequency of up to 4 Hz

Recommended accessories	Product no.
Connection cable, WL 3m	3.0 m long 8564.851
Container (wxhxd) 400x60x200mm	Holds: Instruments, for sterilization (steam and low-temperature), storage and transport, with instrument mat, inner dimensions (wxhxd): 400x57x200mm, outer dimensions (BxHxT): 466x77x266mm 33022

|| Subject to modifications. Please note that some products may not be available in all countries. For more detailed information, please consult with your contact partner or directly with Richard Wolf GmbH.

|| Subject to modifications. Please note that some products may not be available in all countries. For more detailed information, please consult with your contact partner or directly with Richard Wolf GmbH.

Micro Stick S1

Motor handpiece for PowerSpeed AS1

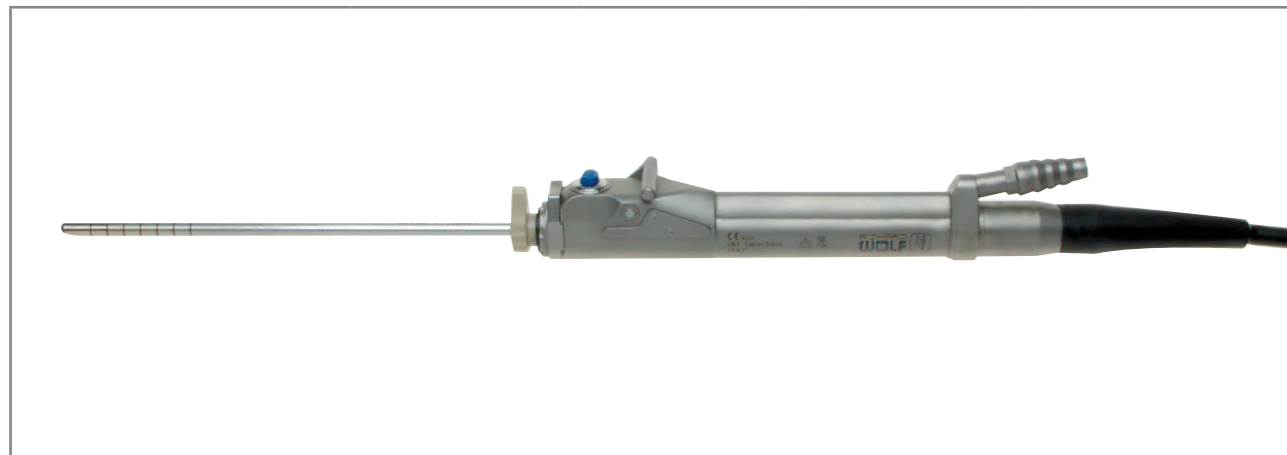

For driving rotation tools with one function button			Ø for shaver tools	Product no.
Motor handpiece max. 3000 rpm	with fixed connection cable, 3.0 m	Operated via the ON/OFF button	2–3.5 mm	899510001

- Mini motor handpiece for exceptional precision in small joints
- Up to 3,000 rpm
- Practical range of accessories
- For shaver tools with a diameter of 2–3.5 mm

Recommended accessories		Product no.
Container (wxhxd) 400x60x200mm	Holds: Instruments, for sterilization (steam and low-temperature), storage and transport, with instrument mat, inner dimensions (wxhxd): 400x57x200mm, outer dimensions (BxHxT): 466x77x266mm	33022

|| Subject to modifications. Please note that some products may not be available in all countries. For more detailed information, please consult with your contact partner or directly with Richard Wolf GmbH.

|| Subject to modifications. Please note that some products may not be available in all countries. For more detailed information, please consult with your contact partner or directly with Richard Wolf GmbH.

Reusable Shaver Blades and Burrs

for Power Stick M5/3 and M5/0 motor handpiece, large interface

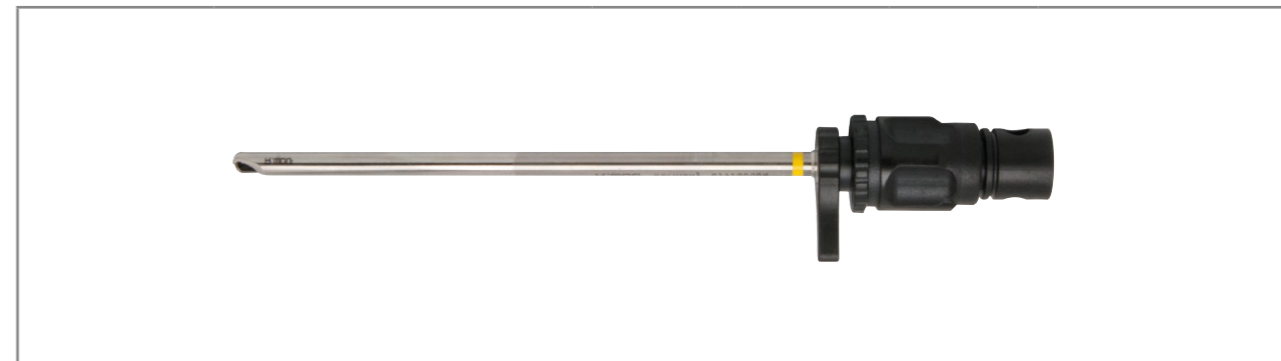

	Reusable (1 PC)	Color coding	WL	Ø	Product no.
	Resector smooth Ø 3.5mm	canary yellow	130 mm	3.5 mm	899750003
	Resector smooth Ø 4.5mm			4.5 mm	899750004
	Resector smooth Ø 5.5mm			5.5 mm	899750005
	Resector toothed Ø 2mm	ocher	45 mm	2.0 mm	89975.0032
	Resector toothed Ø 2.7mm		80 mm	2.7 mm	899750132
	Resector toothed Ø 3.5mm		130 mm	3.5 mm	89975.0033
	Resector toothed Ø 4.5mm			4.5 mm	89975.0034
	Resector toothed Ø 5.5mm			5.5 mm	89975.0035
	Resector aggress Ø 2.7mm	red	80 mm	2.7 mm	899750332
	Resector aggress Ø 3.7mm		130 mm	3.7 mm	89975.0333
	Resector aggress Ø 4.7mm			4.7 mm	89975.0334
	Resector aggress Ø 5.85mm			5.85 mm	899750335
	Resector oval Ø 3.5mm	white	130 mm	3.5 mm	89975.0113
	Resector oval Ø 4.5mm			4.5 mm	89975.0114
	Resector oval Ø 5.5mm			5.5 mm	89975.0115

|| Subject to modifications. Please note that some products may not be available in all countries. For more detailed information, please consult with your contact partner or directly with Richard Wolf GmbH.

|| Subject to modifications. Please note that some products may not be available in all countries. For more detailed information, please consult with your contact partner or directly with Richard Wolf GmbH.

Reusable Shaver Blades and Burrs

for Power Stick M5/3 and M5/0 motor handpiece, large interface



	Reusable (1 PC)	Color coding	WL	Ø	Product no.
	Resector convex curved smooth Ø 3.5mm	canary yellow	130 mm	3.5 mm	89975.0253
	Resector convex curved smooth Ø 4.5mm			4.5 mm	89975.0254
	Resector concave curved smooth Ø 3.5mm	canary yellow	130 mm	3.5 mm	89975.0263
	Resector concave curved smooth Ø 4.5mm			4.5 mm	89975.0264
	End cutter Ø 3.5mm	black	130 mm	3.5 mm	89975.0493
	End cutter Ø 4.5mm			4.5 mm	89975.0494
	Burr round Ø 3mm	gulf blue	80 mm	3.0 mm	89975.0503
	Burr round Ø 4.5mm		130 mm	4.5 mm	89975.0504
	Burr round Ø 5.5mm		5.5 mm	89975.0505	
with lateral protection					
	Burr round Ø 6mm	royal blue	130 mm	6.0 mm	89975.0516
	Acromionizer Ø 3.5mm	purple	130 mm	3.5 mm	89975.0553
	Acromionizer Ø 4.5mm			4.5 mm	89975.0554
	Acromionizer Ø 5.5mm			5.5 mm	89975.0555
	Acromionizer Ø 6.5mm			6.5 mm	89975.0556
with lateral protection					

|| Subject to modifications. Please note that some products may not be available in all countries. For more detailed information, please consult with your contact partner or directly with Richard Wolf GmbH.

|| Subject to modifications. Please note that some products may not be available in all countries. For more detailed information, please consult with your contact partner or directly with Richard Wolf GmbH.

Reusable Shaver Blades and Burrs

for Power Stick M5/3 and M5/0 motor handpiece for hip arthroscopy



	Reusable (1 PC)	Color coding	WL	Ø	Product no.
	Resector toothed Ø 4.7mm	ocher	200 mm	4.7 mm	899732004*
	Resector aggress Ø 4.7mm	red	200 mm	4.7 mm	899732334*
	Resector convex curved aggress Ø 4.7mm	red	200 mm	4.7 mm	899732254
	Resector convex curved aggress Ø 4.7mm	red	200 mm	4.7 mm	899732264
	Burr round Ø 5.5mm	gulf blue	200 mm	5.5 mm	899732504
with 2 mm retracted lateral protection					
	Acromionizer Ø 5.5mm	purple	200 mm	5.5 mm	899732555
with 2 mm retracted lateral protection					

* Shaver blade with distal guide hole for guide wire Ø 2.0 mm

Reusable Shaver Blades and Burrs

for Micro Stick S1,
small interface



	Reusable (1 pc)	Color coding	WL	Ø	Product no.
	Resector toothed Ø 2mm	ocher	45 mm	2.0 mm	89971.0032
	Resector toothed Ø 3.5mm		130 mm	3.5 mm	89971.0033
	Resector toothed Ø 4.5mm			4.5 mm	89971.0034
	Resector toothed Ø 2.5mm		80 mm	2.5 mm	899710132
	Resector aggress Ø 2.7mm	red	80 mm	2.7 mm	899710332
	Resector oval Ø 3.5mm	white	130 mm	3.5 mm	89971.0113
	Resector oval Ø 4.5mm			4.5 mm	89971.0114
	Resector convex curved smooth Ø 4.5mm	canary yellow	130 mm	4.5 mm	89971.0254
	Resector concave curved smooth Ø 4.5mm	canary yellow	130 mm	4.5 mm	89971.0264
	Burr round Ø 3mm	gulf blue	80	3.0 mm	89971.0503

|| Subject to modifications. Please note that some products may not be available in all countries. For more detailed information, please consult with your contact partner or directly with Richard Wolf GmbH.

|| Subject to modifications. Please note that some products may not be available in all countries. For more detailed information, please consult with your contact partner or directly with Richard Wolf GmbH.

Disposable Shaver Blades and Burrs

for Power Stick M5/3 and M5/0 motor handpiece



	Disposable (5 PCS, in individual sterile packaging)	Color coding	WL	Ø	Product no.
	Resector smooth Ø 3.5mm	canary yellow	130 mm	3.5 mm	49975.0003
	Resector smooth Ø 4.5mm			4.5 mm	49975.0004
	Resector smooth Ø 5.5mm			5.5 mm	49975.0005
	Resector toothed Ø 3.5mm	ocher	130 mm	3.5 mm	49975.0033
	Resector toothed Ø 4.5mm			4.5 mm	49975.0034
	Resector toothed Ø 5.5mm			5.5 mm	49975.0035
	Resector aggress Ø 2.5mm	red	80 mm	2.5 mm	499750332
	Resector aggress Ø 3.5mm		130 mm	3.5 mm	49975.0333
	Resector aggress Ø 4.5mm			4.5 mm	49975.0334
	Resector aggress Ø 5.5mm			5.5 mm	49975.0335
	Resector oval Ø 3.5mm	white	130 mm	3.5 mm	49975.0113
	Resector oval Ø 4.5mm			4.5 mm	49975.0114
	Resector oval Ø 5.5mm			5.5 mm	49975.0115

Disposable Shaver Blades and Burrs

for Power Stick M5/3 and M5/0 shaver handle



	Disposable (5 PCS, in individual sterile packaging)	Color coding	WL	Ø	Product no.
	Resector convex curved smooth Ø 3.5mm	canary yellow	130 mm	3.5 mm	49975.0253
	Resector convex curved smooth Ø 4.5mm			4.5 mm	49975.0254
	Resector convex curved smooth Ø 5.5mm			5.5 mm	49975.0255
	Resector concave curved smooth Ø 3.5mm	canary yellow	130 mm	3.5 mm	49975.0263
	Resector concave curved smooth Ø 4.5mm			4.5 mm	49975.0264
	Resector concave curved smooth Ø 5.5mm			5.5 mm	49975.0265
	End cutter Ø4.5 mm	black	130 mm	4.5 mm	49975.0494
	Burr round Ø 4.5mm	gulf blue	130 mm	4.5 mm	49975.0504
	Burr round Ø 6mm	gulf blue	130 mm	6.0 mm	49975.0516
	Acromionizer Ø 3.5mm	purple	130 mm	3.5 mm	49975.0553
	Acromionizer Ø 4.5mm			4.5 mm	49975.0554
	Acromionizer Ø 5.5mm			5.5 mm	49975.0555
	Acromionizer Ø 6.5mm			6.5 mm	49975.0556

|| Subject to modifications. Please note that some products may not be available in all countries. For more detailed information, please consult with your contact partner or directly with Richard Wolf GmbH.

|| Subject to modifications. Please note that some products may not be available in all countries. For more detailed information, please consult with your contact partner or directly with Richard Wolf GmbH.

Disposable Shaver Blades and Burrs

for Power Stick M5/3 and M5/0 shaver handle

for hip arthroscopy



	Disposable (5 PCS, in individual sterile packaging)	Color coding	WL	Ø	Product no.
	Resector curved universal Ø 4.5mm	gray	160 mm	4.5 mm	499732274
	Resector universal Ø 4.5mm	gray	160 mm	4.5 mm	499732344
	Burr oval Ø 5.5mm	purple	160 mm	5.5 mm	499732565





|| Subject to modifications. Please note that some products may not be available in all countries. For more detailed information, please consult with your contact partner or directly with Richard Wolf GmbH.

|| Subject to modifications. Please note that some products may not be available in all countries. For more detailed information, please consult with your contact partner or directly with Richard Wolf GmbH.

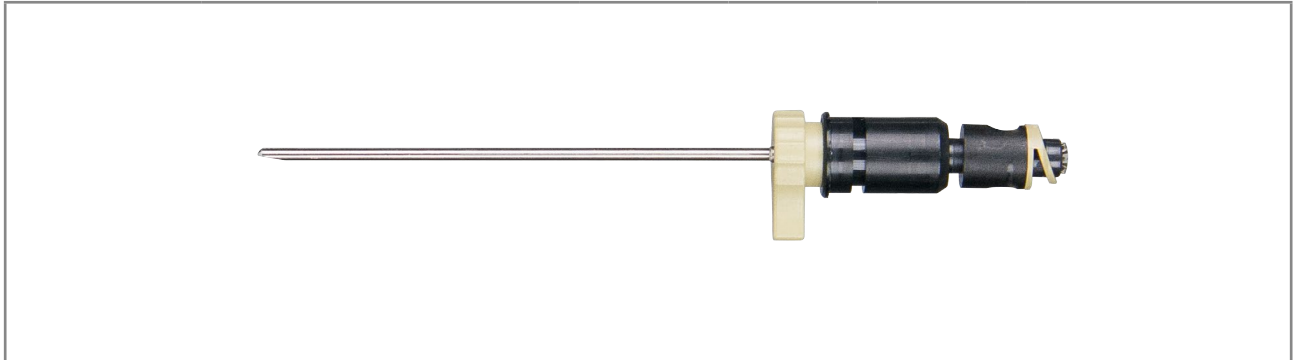
Disposable Shaver Blades and Burrs

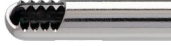
for Micro Stick S1



	Disposable (5 PCS, in individual sterile packaging)	Color coding	WL	Ø	Product no.
	Resector toothed Ø 2mm	ocher	45 mm	2.0 mm	49971.0032
	Resector toothed Ø 3.5mm		130 mm	3.5 mm	49971.0033
	Resector aggress Ø 2.5mm	red	80 mm	2.5 mm	499710332
	Resector oval Ø 3.5mm	white	130 mm	3.5 mm	49971.0113
 with lateral protection	Burr round Ø 3mm	gulf blue	130 mm	3.0 mm	49971.0503
 with lateral protection	Burr oval Ø 3.5mm	canary yellow	130 mm	3.5 mm	49971.0553

VII21 || Subject to modifications. Please note that some products may not be available in all countries. For more detailed information, please consult with your contact partner or directly with Richard Wolf GmbH.



Battery-powered tools bee-system II

for all orthopaedic indications
and large bone surgery

Battery-powered tools bee-system II

8.1 **bee-system II** Drill & Ream machine / Drill machine standard

8.2 **bee-system II** Oscillating Reaming machine / saws

8.3 **Powerpack / Battery charger / Accessories**

bee-system II

Battery-powered tools

for all orthopaedic indications and large bone surgery

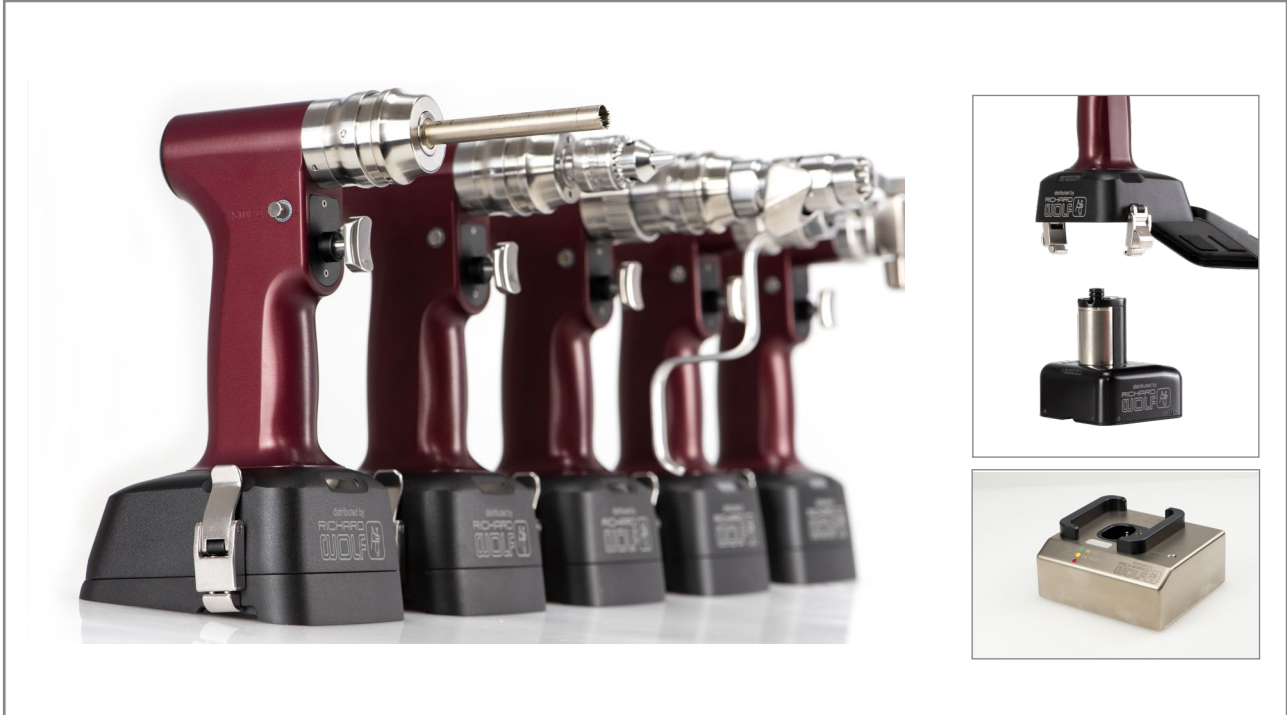

Drill & Ream machine

The new bee-system II universal Drill and Ream handpiece for all orthopaedic indications and large bone surgery. Drill & Ream machine with Right / Left (CW and CCW) rotation lever for oscillating mode on / off and trigger for manual speed regulation with ring for switch Drill and Ream mode.

- With Right / Left (forward / backward rotation)
- Lock position
- Oscillating mode on / off
- Continuously adjustable rotation speed
- Drill with 2 speed ranges, switch to change from Drill to Ream mode

Drill machine standard

The new bee-system II small handpiece for all drill attachments incl. Kirschner pin driver with continuously adjustable rotation speed.

- With Right / Left (CW / CCW) rotation
- Lock position
- Continuously adjustable rotation speed

Oscillating reaming machine

The new Oscillating Reaming machine for use in anterior cruciate ligament reconstruction.

- Lock position
- Continuously adjustable oscillation speed

Oscillating saws

Oscillating saws are available in two versions:

Oscillating saw, 4° (lateral movement) for Synthes / AO saw blades and oscillating saw for Stryker sawblades.

Sagittal oscillating saw in bone surgery:

- With rotatable saw blade clamp in 45° steps (8 positions)
- Manual speed adjustment and oscillating mode
- Shift lever for operating in two different speeds
- With AO-Synthes and Stryker connection of the saw blade

Sternum saw

Sternum saw with protection sleeve and keyless chuck with continuously adjustable rotation speed and switch lever from Step I to II. Basic model can be used as reciprocating saw.

Rotate the attachment / chuck to the desired position. Locking always at 90°.

- Precise cutting guide with good visibility conditions
- Easy clamping of sawblade (no tools required)
- Use of saw blades with Stryker adaption
- Attachment of protection sleeve in 4 different positions possible (locking at 90°)
- Basic model to be used as reciprocating

Powerpack and battery charger

- 1 powerpack for all machines
- 3 chargers with charge status display

bee-system II

Drill and ream machine

for all orthopaedic indications and large bone surgery



		Product no.
beesystemII drill & ream machine	with Right / Left (CW and CCW) rotation lever for oscillating mode on / off and trigger for manual speed regulation with ring for switch Drill and Ream mode	F-31-100-00
Accessories see page Ortho132-Ortho133 / Ortho142		

- With Right / Left (forward / backward rotation)
- Lock position
- Oscillating mode on / off
- Continuously adjustable rotation speed
- Drill with 2 speed ranges, switch to change from Drill to Ream mode

Technical data F-31-100-00	
Handpiece dimensions (without attachment)	162 x 93 x 198 mm
Weight of handpiece with powerpack	1850 g
Continuously adjustable rotation speed	0 - 1000 rpm (drill mode) / 0 - 250 rpm (ream mode)
Cannulation	Ø 4.3 mm
Protection class	B, EN 60601-1
Power supply	Internal battery

bee-system II

Drill machine standard

for all drill attachments incl. Kirschner pin driver with continuously adjustable rotation speed



		Product no.
beesystemII drill machine standard		F-31-150-00
Accessories see page Ortho132-Ortho133 / Ortho142		

- With Right / Left (CW / CCW) rotation
- Lock position
- Continuously adjustable rotation speed

Technical data F-31-150-00	
Handpiece dimensions (without attachment)	137 x 93 x 197 mm
Weight of handpiece with powerpack	1660 g
Continuously adjustable rotation speed	0 - 1000 rpm
Cannulation	Ø 4.3 mm
Protection class	B, EN 60601-1
Power supply	Internal battery









VI121 || Subject to modifications. Please note that some products may not be available in all countries. For more detailed information, please consult with your contact partner or directly with Richard Wolf GmbH.

VI121 || Subject to modifications. Please note that some products may not be available in all countries. For more detailed information, please consult with your contact partner or directly with Richard Wolf GmbH.

bee-system II

Drill & ream and drill machines standard

Accessories

Accessories		for Drill & Ream F-31-100-00	for Drill standard F-31-150-00	Product no.
 Wire/pin driver (for drill/ream)(Ø1-4mm)	for use with K-wires with: Ø 1.0 mm (Drill mode) to Ø 4.0 mm (Ream mode)	•		F-30-100-10
 Wire/pin driver (for standard)(Ø 1-4mm)	for use with K-wires with: Ø 1.0 mm (Drill mode) to Ø 4.0 mm (Ream mode)		•	F-30-100-15
 Extension guide for wire/pin driver		•	•	F-30-100-19
 Adapter for drill guide, radiolucent		•	•	F-30-100-25
 AO-connector small	for drilling and milling, cannulated, Ø 2,5mm	•	•	F-30-100-50
 AO-connector large	for drilling and milling, cannulated, Ø 4,3mm	•	•	F-30-100-51
 1/4" connector	cannulated, Ø 4,3 mm	•	•	F-30-100-52
 Hudson connector	cannulated, Ø 4,3 mm	•	•	F-30-100-53

|| Subject to modifications. Please note that some products may not be available in all countries. For more detailed information, please consult with your contact partner or directly with Richard Wolf GmbH.

|| Subject to modifications. Please note that some products may not be available in all countries. For more detailed information, please consult with your contact partner or directly with Richard Wolf GmbH.

bee-system II

Drill & ream and Drill machines standard

Accessories

Accessories		for Drill & Ream F-31-100-00	for Drill standard F-31-150-00	Product no.
 Harris connector	cannulated, Ø 4,3 mm	•	•	F-30-100-54
 Hexagonal connector SW6	cannulated, Ø 4,3 mm	•	•	F-30-100-55
 DIN coupling for tools		•	•	F-30-100-56
 Drill attachment Jackobs chuck small	with drill chuck key, for drills with sheath diameter 0-4.0mm	•	•	F-30-100-60
 Drill attachment Jackobs chuck large	with drill chuck key, for drills with sheath diameter 0-6.5 mm	•	•	F-30-100-61
 Röhms three jaw chuck	with drill chuck key, for drills with sheath diameter 0-7.0 mm	•	•	F-30-100-62
 Quick action chuck with ratchet	cannulated, Ø 6,0 mm	•	•	F-30-100-63
 Quick action chuck without ratchet	cannulated, max. Ø 6,0 mm	•	•	F-30-100-64
 Albrecht quick action chuck	cannulated, max. Ø 3,5 mm			F-30-100-65

|| Subject to modifications. Please note that some products may not be available in all countries. For more detailed information, please consult with your contact partner or directly with Richard Wolf GmbH.

|| Subject to modifications. Please note that some products may not be available in all countries. For more detailed information, please consult with your contact partner or directly with Richard Wolf GmbH.

bee-system II

Oscillating reaming machine
for use in anterior cruciate ligament reconstruction

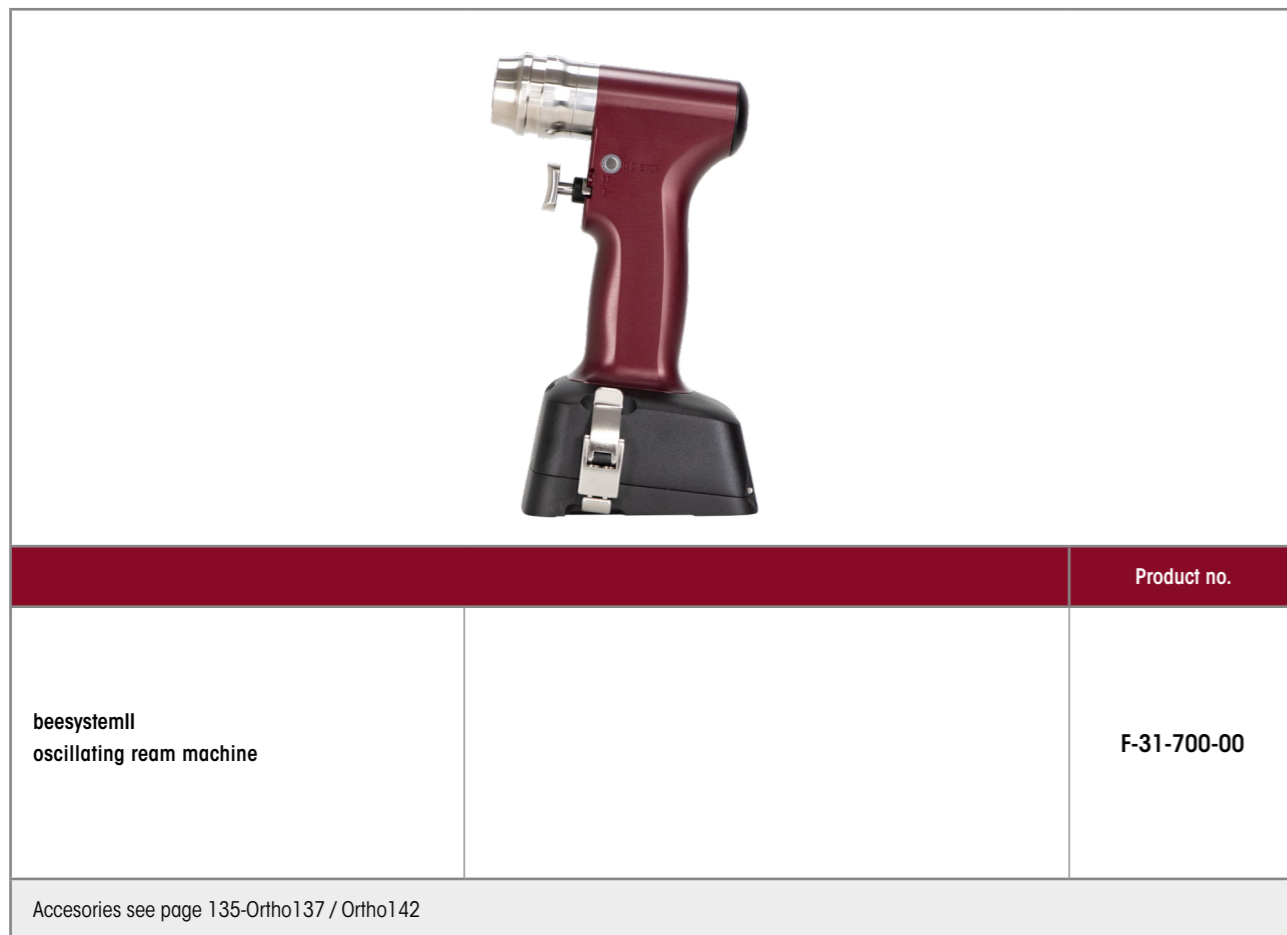

- Lock position
- Continuously adjustable oscillation speed

Technical data F-31-700-00	
Handpiece dimensions (without attachment)	140 x 111 x 206 mm
Weight of handpiece with powerpack	1550 g
Continuously adjustable rotation speed	0 - 9000 rpm (Step 1)/0 - 11000 rpm (Step 11)
Protection class	B, EN 60601-1
Power supply	Internal battery

VI121 || Subject to modifications. Please note that some products may not be available in all countries. For more detailed information, please consult with your contact partner or directly with Richard Wolf GmbH.

VI121 || Subject to modifications. Please note that some products may not be available in all countries. For more detailed information, please consult with your contact partner or directly with Richard Wolf GmbH.

bee-system II

Oscillating reaming machine
Tools for harvesting quadriceps tendon or patellar tendon graft
with bone block for ACL reconstruction

		Inner Ø	Outer Ø	WL	Product no.
Hollow burr SZ 8	<ul style="list-style-type: none"> Cutting teeth only on 2/3 of the distal burr avoids a too big defect on the patella when harvesting the bone block Hollow burrs of different diameters allow to harvest anatomically suitable graft diameters for each patient 	8,4 mm	9,4 mm	90 mm	8869.841
Hollow burr SZ 9		9,4 mm	10,4 mm		8869.843
Hollow burr SZ 10		10,4 mm	11,4 mm		8869.844



		Outer Ø	WL	Product no.
Suture puller WL 350mm	<ul style="list-style-type: none"> Passing the sutures through and pulling the graft into the hollow burr 	4 mm	350 mm	8869.921



		Inner Ø	Outer Ø	WL	Product no.
Bone elevator SZ 8	<ul style="list-style-type: none"> Loosen the bone block from the patella after using a hollow burr 	8,4 mm	11,1 mm	130 mm	8868.921
Bone elevator SZ 9		9,4 mm	11,2 mm		8868.922
Bone elevator SZ 10		10,5 mm	12,5 mm		8868.923

bee-system II

Oscillating reaming machine

Tools for reimplanting and press-fit fixation of BT or BTB grafts

		WL	Product no.
	<ul style="list-style-type: none"> ● Straight version for use via anteromedial portal ● For use via transtibial portal 	110 mm	8869.991

		WL	Product no.
	<ul style="list-style-type: none"> ● Straight version for use via anteromedial portal ● For use via anteromedial portal 	110 mm	8869.993

VI121 || Subject to modifications. Please note that some products may not be available in all countries. For more detailed information, please consult with your contact partner or directly with Richard Wolf GmbH.



VI121 || Subject to modifications. Please note that some products may not be available in all countries. For more detailed information, please consult with your contact partner or directly with Richard Wolf GmbH.



bee-system II

Oscillating reaming machine

Tools for hollow drills sets for harvesting cylindrical bone blocks when creating the tibial drill channel

					
		Außen-Ø	Innen-Ø	NL	Product no.
Hollow drill bit and ejector					
Hollow drill bit SZ 8		8,5 mm	7,4 mm	185	8869849
also: Ejector SZ 8					8869850
Hollow drill bit SZ 9		9,5 mm	8,4 mm	185 mm	8869.851
also: Ejector SZ 9					8869.852
Hollow drill bit SZ 10		10,5 mm	9,4 mm	185 mm	8869.853
also: Ejector SZ 10					8869.854

Base section , aiming spoon and aiming hook		Product no.
	Base section for tibial drill graduated	8874.111
	Aiming hook tibial ACL	8874.121
	Aiming spoon tibial ACL	8874.123

Bohrdrahtführung Hohlbohrer, Bohrerführung Hohlbohrer		Product no.
	Alignment wire guide hollow drill SZ 2.5 for use with base section 8874.111	8874.151
	Drill guide for hollow drill bit SZ 8 for use with base section 8874.111 and hollow drill bit 8869849 SZ 8	8874150
	Drill guide for hollow drill bit SZ 9 for use with base section 8874.111 and hollow drill bit 8869.851 SZ 9	8874.152
	Drill guide for hollow drill bit SZ 10 for use with base section 8874.111 and hollow drill bit 8869.853 SZ 10	8874.153

bee-system II

Oscillating saws

		Product no.
beesystemII sagittal oscillating saw, 4°	(lateral movement) with connection for AO-Synthes saw blades	F-31-300-00
beesystemII sagittal oscillating saw	with connection for Stryker sawblades	F-31-310-00
Accessories see page Ortho142		

- With rotatable saw blade clamping in 45° steps (8 positions)
- Manual speed adjustment and oscillating mode
- Shift lever for operating in two different speeds
- With AO-Synthes and Stryker connection of the saw blade

Technical data F-31-300-00 / F-31-310-00	
Handpiece dimensions (without attachment) 166 x 111 x 211 mm	166 x 111 x 211 mm
Weight of handpiece with powerpack 1760 g	1760 g
Continuously adjustable rotation speed 0 - 9000 cpm (Step 1) / 0 - 11000 cpm (Step II)	0-9.000 Zy./min (Stufe I) / 0-11.000 Zy./min (Stufe II)
Protection class B, EN 60601-1	B, EN 60601-1
Power supply Internal battery	Interner Akku

VI121 || Subject to modifications. Please note that some products may not be available in all countries. For more detailed information, please consult with your contact partner or directly with Richard Wolf GmbH.

VI121 || Subject to modifications. Please note that some products may not be available in all countries. For more detailed information, please consult with your contact partner or directly with Richard Wolf GmbH.

bee-system II

Sternum saw

		Product no.
beesystemII sternum saw	with keyless sternum attachment (F-30-400-05)	F-31-601-00
Accessories see page Ortho142		

- Precise cutting guide with good visibility conditions
- Easy clamping of sawblade (no tools required)
- Use of saw blade with Stryker adaption
- Attachment of protection sleeve in 4 different positions possible (locking at 90°)
- Basic model to be used as reciprocating

Technical data F-31-601-00	
Handpiece dimensions (without attachment)	185 x 111 x 206 mm
Weight of handpiece with powerpack	1750 g
Continuously adjustable rotation speed	0 - 7500 cpm (Step 1)/0 - 10000 cpm (Step 11)
Protection class	B, EN 60601-1
Power supply	Internal battery

bee-system II

One powerpack for all machines



		Product no.
Power Pack	Powerpack, universal drive unit for use with all bee-system handpieces, newest Li-Ion technology	F-30-900-00

also: Battery charger see page Ortho141

- 1 powerpack for all handpieces
- Includes control unit, battery, electronics, and motor – united in one powerpack
- Automatic recognition of the performance parameters according to the used handpiece
- Unique durability, no need to sterilize delicate components
- Latest battery technology – long lifetime, no memory effect
- Display for battery charging status: green, orange, red (discharged)
- White LEDs for additional illumination of the OR field

Technical data F-30-900-00	
Dimensions	89 x 87 x 102 mm
Weight	760 g
Type	Li-ion
Max. voltage	16.8 V
Operating voltage (rated voltage)	14.4V
Capacity	2.1 Ah
Typical charging time period	< 90 min

bee-system II

Battery charger



		Product no.
Battery charger (1 charging slot)		F-30-900-50
Battery charger (2 charging slots)		F-30-900-51
Battery charger (4 charging slots)		F-30-900-52

- All charging units indicate the charging status of the powerpacks.
- In addition to the charging status at the powerpack, the charger displays the charging capacity per powerpack slot.

Technical data F-30-900-50/51/52	
Dimensions	1 charging slot: 157 x 140 x 79 mm 2 charging slots: 240 x 190 x 130 mm 4 charging slots: 520 x 190 x 130 mm
Weight	1 charging slot: 1740 g 2 charging slots: 4939 g 4 charging slots: 8700 g
Type	Li-ion battery charger
Input	100 - 240 V AC 50 - 60 Hz 0,9 A
Output	16,8 V DC 2,0 A







VI121 || Subject to modifications. Please note that some products may not be available in all countries. For more detailed information, please consult with your contact partner or directly with Richard Wolf GmbH.

VI121 || Subject to modifications. Please note that some products may not be available in all countries. For more detailed information, please consult with your contact partner or directly with Richard Wolf GmbH.

bee-system II

Accessories



Accessories for bee-system II		Product no.
	Tray with lid, for 1 machine without rinsing set, reusable	F-31-910-13
	Tray with lid, for 2 machines without rinsing set, reusable	F-31-910-18
	Rinsing set reusable	F-30-910-40
	Cleaning brush set reusable	F-30-910-50
	Hi-tech oil pen	F-30-900-61
	Sterile funnel for insertion of powerpack F-30-900-00 under sterile conditions, reusable	F-30-900-20
	Lubrication service frame reusable	F-30-900-10
	Poag cable for charging units for connecting F-30-900-50 or F-30-900-51 or F-30-900-52 to potential equalization	F-30-900-57

||| Subject to modifications. Please note that some products may not be available in all countries. For more detailed information, please consult with your contact partner or directly with Richard Wolf GmbH.

