

THORACIC ENDOSCOPY

THORACIC ENDOSCOPY

1

BRONCHOSCOPY

1.1

FLEXIBLE SENSOR BRONCHOSCOPES

1.2

TEXAS MODEL BRONCHOSCOPE / ENDOBRONCHIAL SAW BLADES

1.3

TIPCONTROL / ERAGONBIPOLAR FORCEPS

1.4

BRONCHOSCOPE / TRACHEOSCOPE TUBES

1.5

PANOVIEW TELESCOPES

1.6

OPTICAL FORCEPS / BRONCHOSCOPE FORCEPS

1.7

ACCESSORIES

2

PEDIATRIC BRONCHOSCOPY

3

THORACOSCOPY

4

MEDIASTINOSCOPY

FLEXIBLE 1-CHANNEL SENSOR BRONCHOSCOPE "SLIM" FOR ENDOCAM Logic 4K CONTROLLER



DIAGNOSTIC MODEL	Outer Ø	Working channel	WL	TL	Direction of view	Angle of view	Product no.
Sensor bronchoscope Ø 3.3 mm WL 680 mm with suction valve	3.3 mm	1.5 mm	680 mm	980 mm	6.5°	90°	7235011

Recommended accessories		Product no.
Perforated basket for flexible endoscopes for this: fixing ring Ø 50.39 mm		(W x H x D): 448 x 106 x 288 mm 33016
		643301261
Flexible auxiliary instruments		see Thorax5

FLEXIBLE 1-CHANNEL SENSOR BRONCHOSCOPE

"SLIM"

TECHNICAL DATA











SENSOR BRONCHOSCOPE

1.1

Sensor bronchoscope	7235011
Sheath Ø	3.3 mm
Working / irrigation channel Ø	1.5 mm
Angle	150° upward, 150° downward
Working length	680 mm
Angle of view	90°
Illumination	Two LEDs in handle, no separate light source required
Handle	Ergonomic handle design with axial cable outlet
Positioning of the working and irrigation channels in relation to the picture	At 9 o'clock
Endopicture	Square, digital 6x zoom Automatic white balance, light control, and focus
Cable length	2.5 m
Compatible endocamera	ENDOCAM Logic 4K ENDOCAM Logic HD ENDOCAM Logic HD lite

ENDOCAM LOGIC 4K – video equipment	Product no.
 <p>ENDOCAM Logic 4K camera control unit bndl consisting of: ENDOCAM Logic 4K camera control unit (5525301) Handheld remote control (5525401) 1x USB flash memory 32 GB (72321829) 1x HDMI/HDMI cable, lockable, 3.0 m (103847) 1x power cable (2440.03)</p>	55253011

FLEXIBLE 1-CHANNEL SENSOR BRONCHOSCOPE "SLIM" ACCESSORIES AND AUXILIARY INSTRUMENTS

Recommended accessories	Outer Ø	Product no.	
 Flex. grasping forceps 3 FR WL 920 mm	1.0 mm	828.651	
 Flex. biopsy forceps 3 FR WL 920 mm	1.0 mm	829.601	
 Biopsy valve receptacle (for sealing valve 15114.052)		15114175	
 Sealing valve, bundle (20 pcs)		15114.052	
 Clamping attachment		8290020	
 Seal		15176173	
 Suction valve for bronch. sterile (PU = 20 pcs)		4565901M	
 Irrigation adapter for machine cleaning or manual flushing of flexible bronchoscopes with suction valve		163912	
 Tube with LUER-LOCK connector		886.00	
 Luer sealing cap for sealing the 2nd Luer connector or for sealing the probe channel if the bronchoscope should only be used for suction		15023205	
 Adapter for automatic leak test		163.905	
 Leak tester for flexible endoscopes		163.903	
 Pressure equalization valve for low-temperature sterilization procedure with n hydrogen peroxide H2O2 and n Low Temperature Steam Formaldehyde (LTSF)		163.904	
 Cleaning brush Ø 2 mm TL 1200 mm for flexible endoscopes with channel Ø 1.0-1.5 mm, Brush length 15 mm, PACK = 10 pcs, color: yellow for single use		7990001	
 Double conical straight cleaning brush for connections to the suction and working channel, PACK=50 pcs, color: red for single use		7980002	
 Cleaning brush straight, PACK = 10 PCS for single use		8691	
	Laser fiber Ø 200 µm, disposable, sterile (PU = 1 pcs)	200 µm	487501200
	Laser fiber Ø 272 µm, disposable, sterile (PU = 1 pcs)	272 µm	487501272
	Laser fiber Ø 200 µm, reusable, sterile (PU = 1 pcs)	200 µm	87501200
	Laser fiber Ø 272 µm, reusable, sterile (PU = 1 pcs)	272 µm	87501272
	Laser fiber Ø 365 µm, reusable, sterile (PU = 1 pcs)	365 µm	875013650

OPTICAL BRONCHOSCOPE TEXAS MODEL

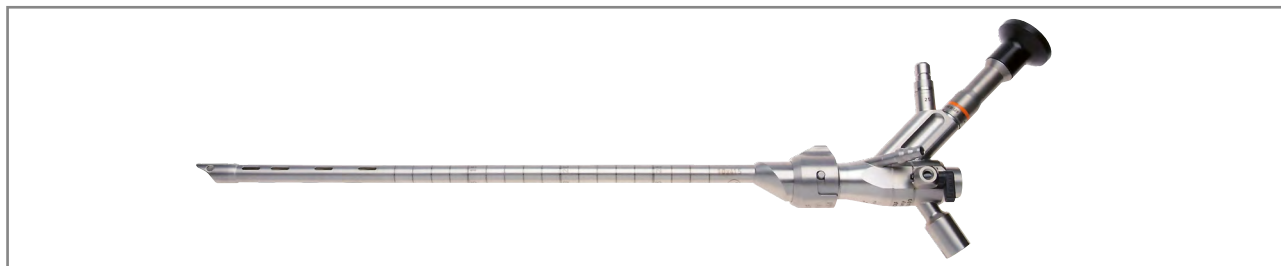



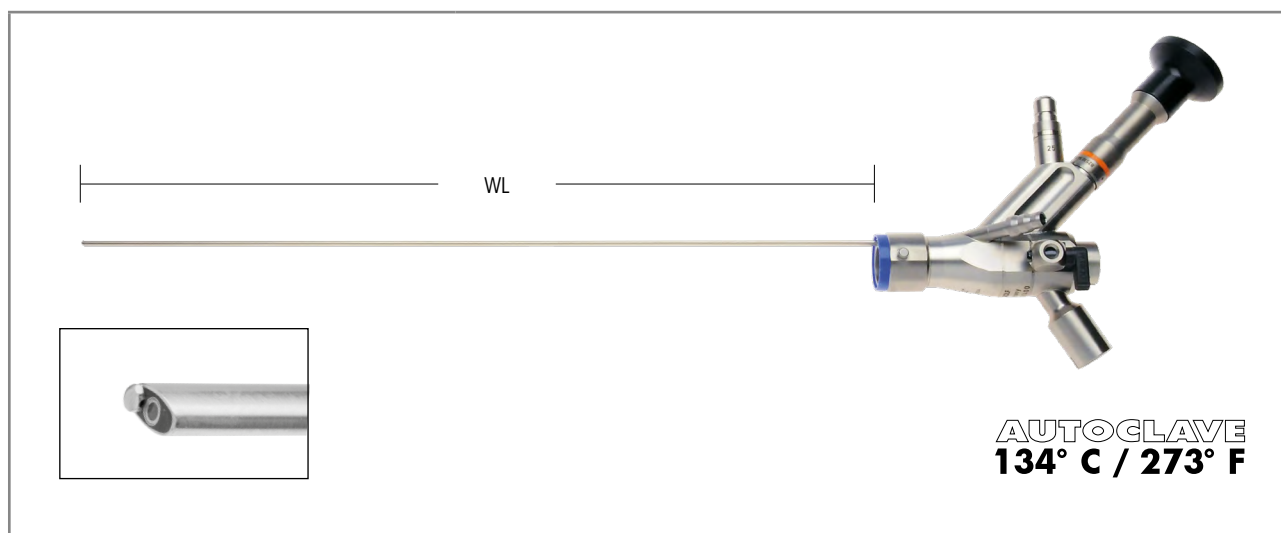







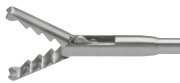
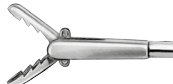

- The endoscope is integrated directly into the bronchoscope tube and offers an optimal view at all times.



		Product no.
Optic element bundle	consisting of: Telescope 17° W 4.4 mm H 2 mm WL 314 mm (82510.1400) Respiration adapter for jet ventilation (8238.502) Connection part for bronch. nozzle (15401.071) Rubber cap without holes (88.00) Spare O-ring for 15401.071 (PU = 5 PCS) (9500.071) Spare seal, 5 PCS (15176141)	825101401



Optional accessories		
Fiber light cable bndl consisting of: Fiber light cable Ø 2.5 mm TL 2.3 m (80662523), projector-side adapter (8095.07), and endoscope-side adapter (809509)	Ø 2.5 mm, 2.3 m long	806625231
Accessories and auxiliary instruments		see THORAX7
Bronchoscope / tracheoscope tubes Texas model		see THORAX10

OPTICAL BRONCHOSCOPE TEXAS MODEL ACCESSORIES AND AUXILIARY INSTRUMENTS

Recommended accessories		Product no.	
	Grasping forceps WL 465 mm, serrated	8280.41	
	Universal forceps WL 465 mm, serrated	8280.42	
	Biopsy forceps WL 460 mm, smooth	8280.43	
	Grasping forceps WL 465 mm	8280.47	
	Sealing cap for bronch. with telescope sealing cap for telescopes Ø 5.5 mm	8020.18	
	Sealing cap for bronch. with telescope sealing cap for telescopes Ø 4 mm, 3.4 mm, and 2.7 mm	8021.18	
	Universal cap for bronch.	8020.15	
	Spare telescope sealing caps (PACK=10 PCS)		
	for telescopes Ø 5,5 mm	Sealing cap CAP 5,1-6,0 mm	89.03
	for telescopes Ø 4 mm	Sealing cap CAP 3,4-5,1 mm	89.02
	8238.502	Respiration adapter jet ventilation bndl consisting of: Respiration adapter for jet ventilation (8238.502) and Luer connector (15401.071)	8238.5021
	15401.071		
		82510.0011	
For optic element bundle (825101401): Protection sleeve, bndl for transportation, reprocessing, and sterilization		 15208.289	
	Container (W x H x D): 500 x 60 x 200 mm	33024	
	Perforated basket for small parts (W x H x D): 128 x 35 x 121 mm	33006	

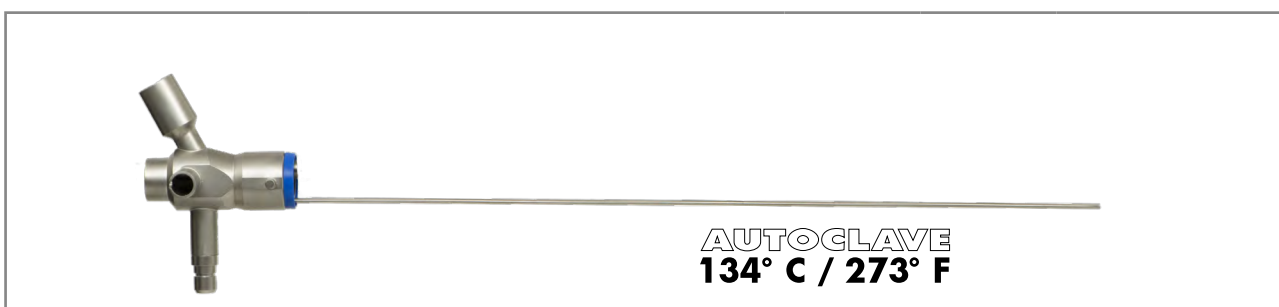











**BRONCHOSCOPE
TEXAS MODEL**



		Inner Ø	TL	Product no.
	Head system for TEXAS bronchoscope with distal illumination	14.0 mm	372 mm	825101100
	Head system for TEXAS bronchoscope with proximal illumination	14.0 mm	373 mm	825101200

Optional accessories	
Accessories and auxiliary instruments	see THORAX9

BRONCHOSCOPE TEXAS MODEL ACCESSORIES AND AUXILIARY INSTRUMENTS

Recommended accessories		Product no	
	Sealing cap with monitoring window	8205.12	
	Sealing cap (blue)	8205.13	
	Sealing cap for bronch. with telescope sealing cap for telescopes Ø 5.5 mm	8020.18	
	Sealing cap for bronch. with telescope sealing cap for telescopes Ø 4 mm, 3.4 mm, and 2.7 mm	8021.18	
	Uni.-Verschlusskappe für Bronch.	8020.15	
	Spare telescope sealing caps (PACK=10 PCS)		
	for telescopes Ø 5,5 mm	Sealing cap CAP 5,1-6,0 mm	89.03
	for telescopes Ø 4 mm	Sealing cap CAP 3,4-5,1 mm	89.02
	for telescopes Ø 2,7 mm und 3,4 mm	Sealing cap CAP 2,4-3,4 mm	89.01
 8238.502	Respiration adapter jet ventilation bndl consisting of: Respiration adapter for jet ventilation (8238.502) and Luer connector (15401.071)	8238.5021	
 15401.071			
	Illumination insert	8217.12	
	Sealing plugs TL 25 mm	8256.99	
	Endoscope-side adapter for connecting a STORZ light cable to WOLF endoscopes	8088.00	
	Container (W x H x D): 500 x 60 x 200 mm	33024	
	Perforated basket for small parts (W x H x D): 128 x 35 x 121 mm	33006	

BRONCHOSCOPE / TRACHEOSCOPE TUBE TEXAS MODEL

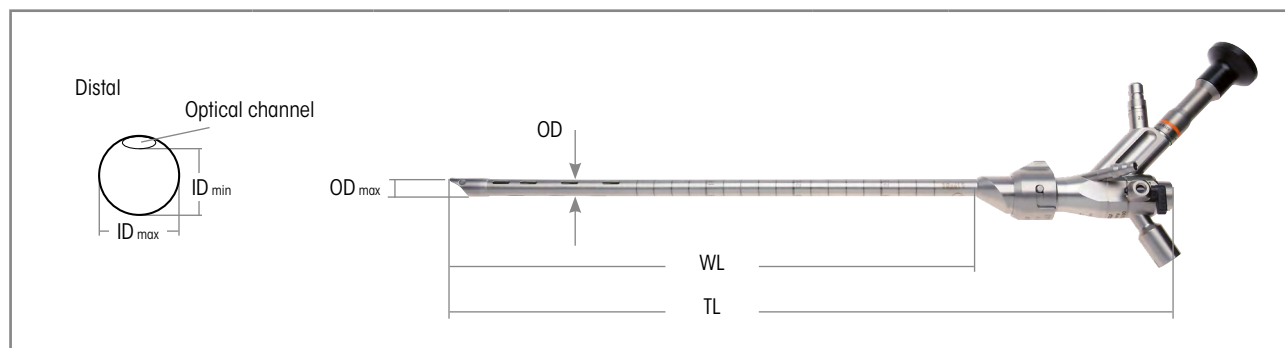

TEXAS	minimal inner Ø (ID min)	maximal inner Ø (ID max)	Insertion part outer Ø (OD max)	Sheath outer Ø (OD)	WL	TL (with adapted telescope element)	Product no.
Bronchoscope tube ID 9.2 mm	6 mm	9,2 mm	11,4 mm	10 mm	305 mm	415 mm	82520.0641
Bronchoscope tube ID 11 mm	8 mm	11 mm	13,2 mm	12 mm	310 mm	415 mm	82520.0841
Bronchoscope tube ID 11 mm without distal viewing window	8 mm	11 mm	13,2 mm	12 mm	310 mm	415 mm	82520.0842
Bronchoscope tube ID 13 mm	10 mm	13 mm	15,2 mm	14 mm	318 mm	420 mm	82520.1041
Tracheoscope tube ID 15 mm	12 mm	15 mm	17,2 mm	16 mm	325 mm	420 mm	82520.1241
Tracheoscope tube ID 17.1 mm	14 mm	17,1 mm	19,3 mm	18 mm	330 mm	425 mm	82520.1441



Tracheoscope tube ID 11 mm	8 mm	11 mm	13,2 mm	12 mm	295,5 mm	405 mm	825210830
Tracheoscope tube ID 13 mm	10 mm	13 mm	15,2 mm	14 mm	300 mm	405 mm	825211030
Tracheoscope tube ID 15 mm	12 mm	15 mm	17,2 mm	16 mm	300 mm	403 mm	825211230
Tracheoscope tube ID 17 mm	14 mm	17 mm	19,3 mm	18 mm	300 mm	403 mm	825211430

ENDOBONCHIAL SHAVER BLADES

FOR GENTLE AND SAFE TISSUE RESECTION AND MUCUS REMOVAL



MOTOR CONTROL UNIT 2304

Power supply connection 50/60 Hz, 230 V

Includes power supply cable, CAN bus connection cable, and packaging

2304.001

For connecting the motor handpieces M4, M5/0, M5/3, S1, and M1, connection option for 2 handpieces and one footswitch, compatible with core, dimensions (W x H x D): 330 x 155 x 365 mm

Recommended accessories		Product no.
Footswitch, 2 pedals		2304.901



For driving rotation tools with one function button			Ø for shaver tools	Product no.
Motor handpiece max. 3,000 rpm	with fixed connection cable, 3.0 m	Operation via ON/OFF button	2-3.5 mm	89951.0001

V124 || Subject to modifications. Please note that some products may not be available in all countries. Please always take note of the information that is provided with the product. For more detailed information, please consult with your contact partner or directly with Richard Wolf GmbH.

ENDOBONCHIAL SHAVER BLADES

FOR GENTLE AND SAFE TISSUE RESECTION AND MUCUS REMOVAL

ENDOBONCHIAL SHAVER BLADES

1.2

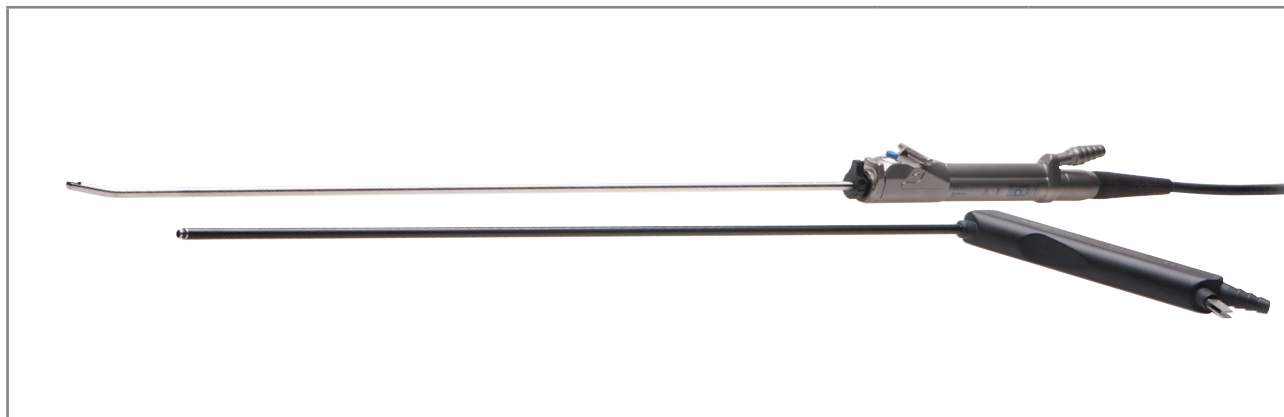





	Reusable (1 pc)	WL	Ø	Product no.
	Resector, curved Ø 4.5 mm WL 460 mm	460 mm	4.5 mm	825620446
	Resector, curved, smooth Ø 4.5 mm WL 460 mm		4.5 mm	825610446
	Resector, aggressive Ø 5.5 mm WL 460 mm		5.5 mm	825630546
	Secretion remover Ø 5.5 mm WL 448 mm		5.5 mm	825640546
	HF coagulation suction tube OD 5.2 mm WL 460 mm		5.2 mm	844202110

Recommended accessories	Product no.
Optic element bundle Endoscope with fiber image guide, TEXAS model, DOV 12°, with integrated lens irrigation and protective sheath	82510.1400
Tracheoscope tube ID 11 mm for telescope element 82510.1400, OD 13.2 mm, WL 295.5 mm	825210830
Tracheoscope tube ID 13 mm for telescope element 82510.1400, OD 15.2 mm, WL 299 mm	825211030

V124 || Subject to modifications. Please note that some products may not be available in all countries. Please always take note of the information that is provided with the product. For more detailed information, please consult with your contact partner or directly with Richard Wolf GmbH.

ARTICULATED FORCEPS FOR RIGID BRONCHOSCOPY TIPCONTROL



TipControl	Outer Ø	WL	TL	Product no.
Biopsy forceps Ø 5.2 mm 483 mm 	5.2 mm	483 mm	645 mm	823400001
Grasping forceps Ø 5.2 mm 485 mm 	5.2 mm	485 mm	647 mm	823400002
Scissors Ø 5.2 mm 482 mm 	5.2 mm	482 mm	644 mm	823400003

Optional accessories	Product no.
Luer sealing cap	15023205



BIPOLAR FORCEPS FOR EXCISIONAL BIOPSY
FOR RIGID BRONCHOSCOPY

ERAGON bipolar



ERAGONBIPOLAR FORCEPS

1.3

Jaw insert		Sheath tube Ø 5.5 mm SL 435 mm	Handle, pistol-shaped, bipo	Complete instrument • Jaw insert with sheath tube • Handle
		SL 435 mm	rotatable	
Product no.		82340024	839300102	Product no.
Bipolar forceps bndl Ø 5.5 mm 		82340014	•	•
				823400005

Optional accessories	
Bipolar connection cable	See THORAX109/110

BRONCHOSCOPE TUBE

WOLF model

with distal illumination

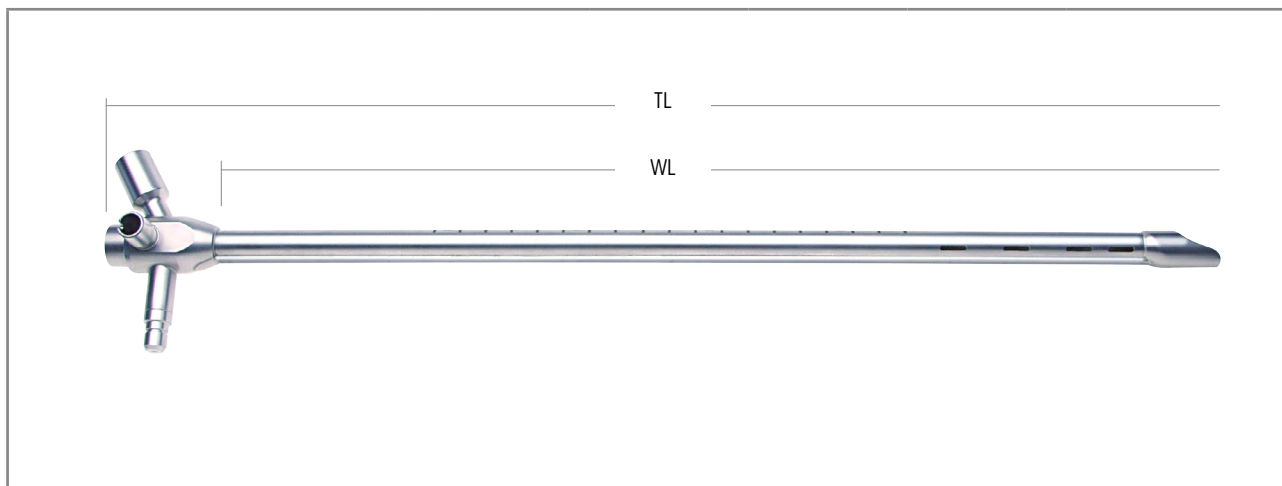

with fixed distal light carrier	Inner Ø	Outer Ø	WL	TL	Product no.
Bronchoscope tube bndl consisting of: Bronchoscope tube ID 7.5 mm (8214.072) and sealing cap (8205.13*)	7.5 mm	8.5 mm	357 mm	400 mm	8214.0721
Bronchoscope tube bndl consisting of: Bronchoscope tube ID 8.5 mm (8214.082) and sealing cap (8205.13*)	8.5 mm	9.5 mm		400 mm	8214.0821
Bronchoscope tube bndl consisting of: Bronchoscope tube ID 7.5 mm (8214.092) and sealing cap (8205.13*)	9.5 mm	8.5 mm		400 mm	8214.0921
Bronchoscope tube bndl consisting of: Bronchoscope tube ID 10.5 mm (8214.102) and sealing cap (8205.13*)	10.5 mm	11.5 mm	387 mm	430 mm	8214.1021

* for the lateral respiration nozzle.

Matching adapter for telescope			
Matching bronchoscope tube bndl	8214.1021	8214.0721 8214.0821 8214.0921	
Matching telescope 0° Ø 5.5 mm WL 488 mm	8465.30	8465.30 8465.30	
Adapter for telescope TL 94 mm	8215.714		
Adapter for telescope TL 124 mm		8215.715	

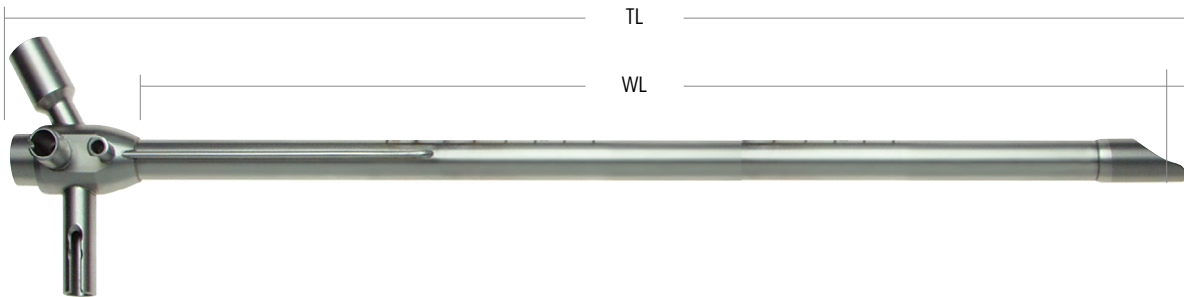

V124 || Subject to modifications. Please note that some products may not be available in all countries. Please always take note of the information that is provided with the product. For more detailed information, please consult with your contact partner or directly with Richard Wolf GmbH.

BRONCHOSCOPE TUBE HEMER MODEL

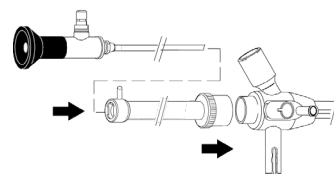

with proximal illumination and sampling channel, graduated	Inner Ø	Outer Ø	WL	TL	Product no.
Bronchoscope tube bndl consisting of: Bronchoscope tube ID 6.5 mm (8214.064), Luer sealing cap (15023205), sealing cap (8205.13*), and sealing plug TL 25 mm (8256.99)	6.5 mm	7.5 mm	357 mm	400 mm	8214.0641
Bronchoscope tube bndl consisting of: Bronchoscope tube ID 7.5 mm (8214.074), Luer sealing cap (15023205), sealing cap (8205.13*), and sealing plug TL 25 mm (8256.99)	7.5 mm	8.5 mm			8214.0741
Bronchoscope tube bndl consisting of: Bronchoscope tube ID 8.5 mm (8214.084), Luer sealing cap (15023205), sealing cap (8205.13*), and sealing plug TL 25 mm (8256.99)	8.5 mm	9.5 mm	387 mm	430 mm	8214.0841
Bronchoscope tube bndl consisting of: Bronchoscope tube ID 9.5 mm (8214.094), Luer sealing cap (15023205), sealing cap (8205.13*), and sealing plug TL 25 mm (8256.99)	9.5 mm	10.5 mm			8214.0941
Bronchoscope tube bndl consisting of: Bronchoscope tube ID 10.5 mm (8214.104), Luer sealing cap (15023205), sealing cap (8205.13*), and sealing plug TL 25 mm (8256.99)	10.5 mm	11.5 mm			8214.1041
Bronchoscope tube bndl consisting of: Bronchoscope tube ID 12 mm (8214.126), Luer sealing cap (15023205), sealing cap (8205.13*), and sealing plug TL 25 mm (8256.99)	12.0 mm	13.0 mm			8214.1261

* for the lateral respiration nozzle.

Matching adapter for telescope				
Matching Bronchoscope tube bndl	8214.0841 8214.0941 8214.1041 8214.1261	8214.0641 8214.0741	8214.1241	
Matching telescope 0° Ø 5.5 mm WL 488 mm	8465.30	8465.30	8465.30	
Adapter for telescope TL 94 mm	8215.714			
Adapter for telescope TL 124 mm		8215.715		
Adapter for telescope TL 174 mm			8215.716	

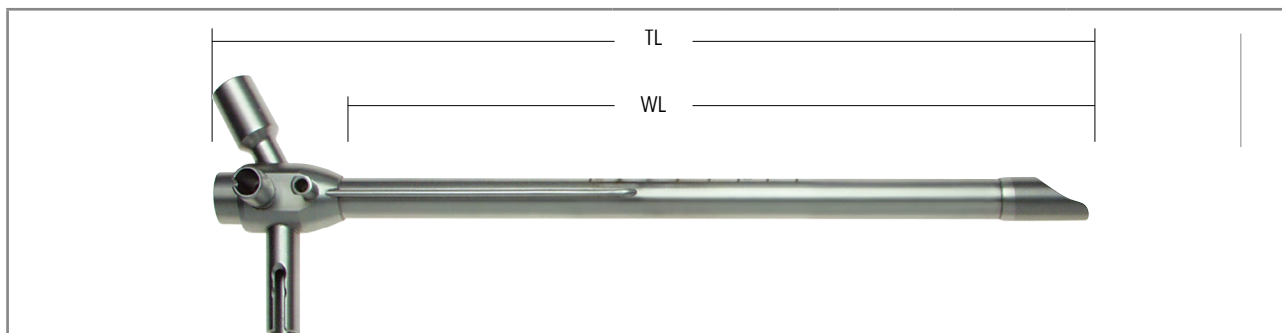

V124 | Subject to modifications. Please note that some products may not be available in all countries. Please always take note of the information that is provided with the product. For more detailed information, please consult with your contact partner or directly with Richard Wolf GmbH.

TRACHEOSCOPE TUBE HEMER MODEL

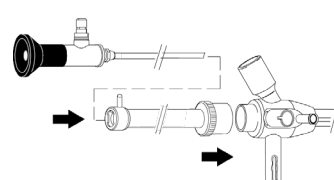

with proximal illumination and sampling channel, graduated	Inner Ø	Outer Ø	WL	TL	Product no.
Tracheoscope tube bndl consisting of: Tracheoscope tube ID 12 mm (8214.124) Luer sealing cap (15023205), sealing cap (8205.13*), and sealing plug TL 25 mm (8256.99)	12 mm	13 mm	307 mm	350 mm	8214.1241
Tracheoscope tube bndl consisting of: Tracheoscope tube ID 12 m (8214.128), Luer sealing cap (15023205), sealing cap (8205.13*), and sealing plug TL 25 mm (8256.99)	12 mm	13 mm	257 mm	300 mm	8214.1281
Tracheoscope tube bndl consisting of: Tracheoscope tube ID 14 mm (8214.144), Luer sealing cap (15023205), sealing cap (8205.13*), and sealing plug TL 25 mm (8256.99)	14 mm	15 mm		300 mm	8214.1441

* for the lateral respiration nozzle.









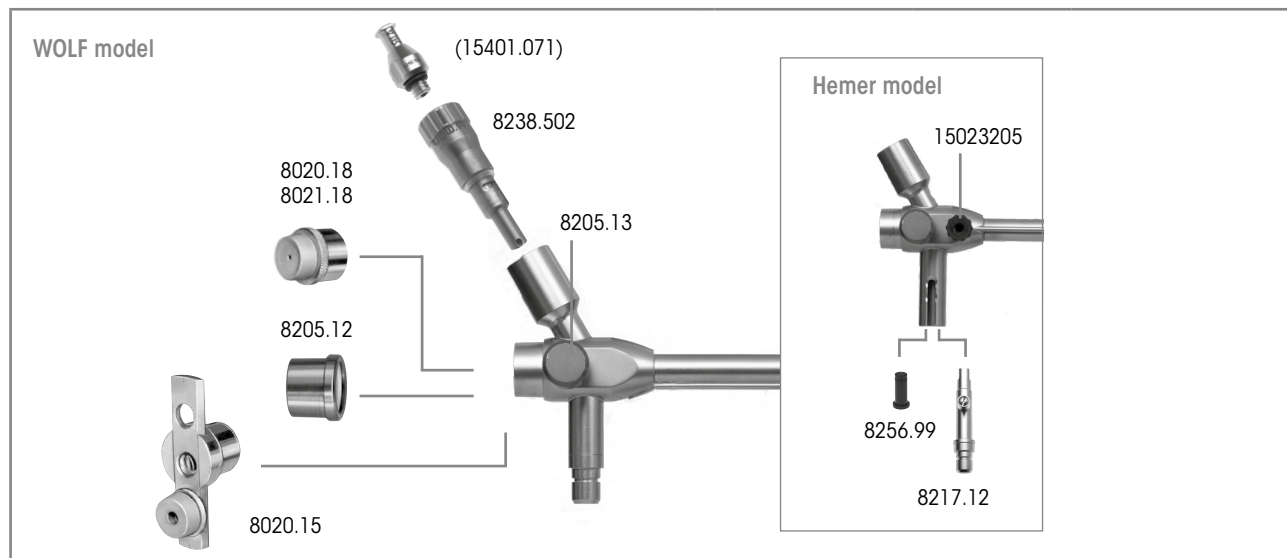





Matching adapter for telescope		
Matching tracheoscope tube bndl	8214.1281 8214.1441	
Matching telescope 0° Ø 5.5 mm WL 488 mm	8465.30	
Adapter for telescope TL 211 mm	8215.713	

WOLF MODEL BRONCHOSCOPE TUBE

HEMER MODEL BRONCHOSCOPE / TRACHEOSCOPE TUBE

ACCESSORIES AND AUXILIARY INSTRUMENTS



Recommended accessories		Product no.
	Sealing cap with monitoring window	8205.12
	Sealing cap (blue)	8205.13
	Luer sealing cap	15023205
	Sealing cap for bronchoscope with telescope sealing cap for telescopes Ø 5.5 mm	8202.18
	Sealing cap for bronchoscope with telescope sealing cap for telescopes Ø 4 mm, 3.4 mm, and 2.7 mm	8201.18
	Universal cap for bronch.	8202.15
	Spare telescope sealing caps (Pack=10 PCS)	
	for telescopes Ø 5,5 mm	Sealing cap cap 5.1-6.0 mm 89.03
	for telescopes Ø 4 mm	Sealing cap cap 3.4-5.1 mm 89.02
	for telescopes Ø 2,7 mm and 3,4 mm	Sealing cap cap 2.4-3.4 mm 89.01
	Respiration adapter jet ventilation bndl consisting of:	8238.5021
	Respiration adapter for jet ventilation (8238.502) and Luer connector (15401.071)	
	Illumination insert	8217.12
	Endoscope-side adapter for connecting a WOLF light cable to WOLF endoscopes (only with models 82514.xxx in connection with 8217.12)	8095.00
	Sealing plugs TL 25 mm	8256.99
	(W x H x D) 500 x 60 x 200 mm	33024
	Perforated basket for small parts (W x H x D): 128 x 35 x 121 mm	33006

V124 || Subject to modifications. Please note that some products may not be available in all countries. Please always take note of the information that is provided with the product. For more detailed information, please consult with your contact partner or directly with Richard Wolf GmbH.

PANOVIEW TELESCOPE

Ø 3.4 MM / Ø 4.0 MM / Ø 5.5 MM

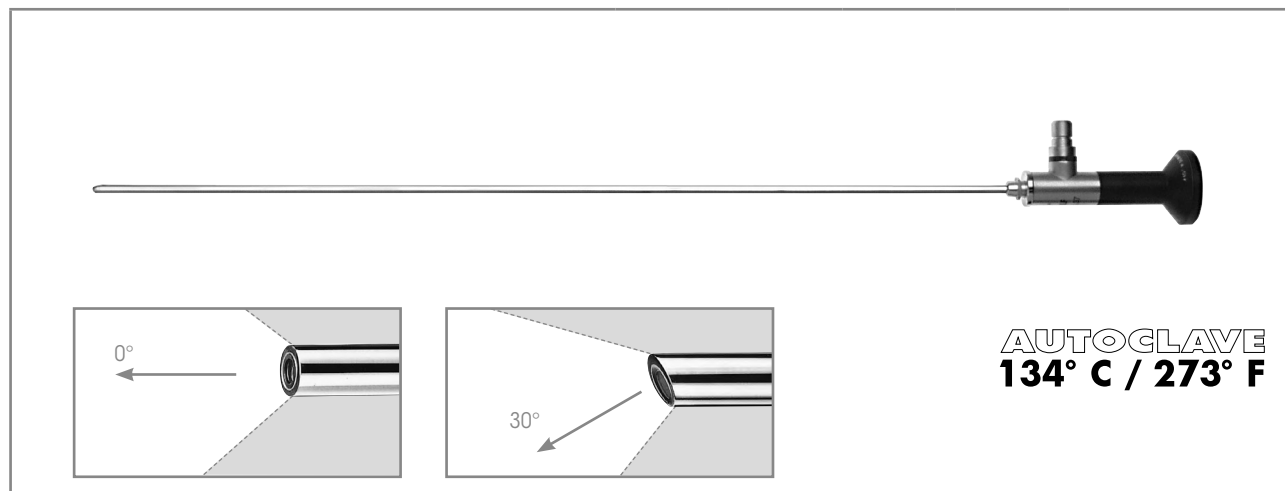





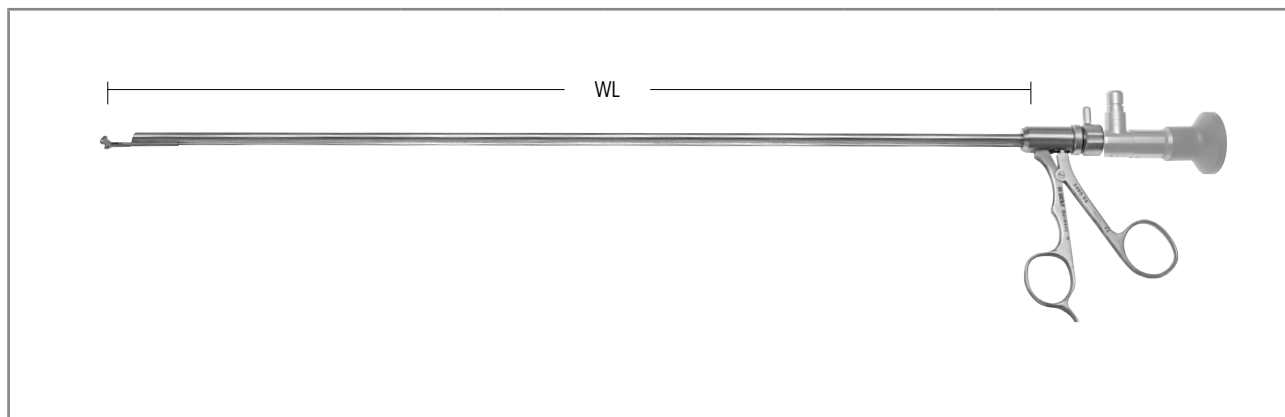

	Direction of view	WL	TL	Ø	Product no.
PANOVIEW Telescope 0° Ø 3.4 mm WL 378 mm	0°	378 mm	457 mm	3.4 mm	8464.30
PANOVIEW PLUS Telescope 0° Ø 4 mm WL 519 mm	0°	519 mm	595 mm	4.0 mm	82514.431
PANOVIEW PLUS Telescope 30° Ø 4 mm WL 519 mm	30°				82514.433
PANOVIEW Telescope 0° Ø 5.5 mm WL 488 mm	0°	488 mm	564 mm	5.5 mm	8465.30
PANOVIEW Telescope 30° Ø 5.5 mm WL 489 mm	30°	489 mm	565 mm		8465.32

Recommended accessories		Product no.
Perforated basket for standard telescope 2	(W x H x D) 481 x 54 x 59 mm	38016
Perforated basket for standard telescope 3	(W x H x D) 619 x 54 x 59 mm	38017
Fiber light cable bndl consisting of: Fiber light cable (80662523), projector-side adapter (8095.07), and endoscope-side adapter (809509)	Ø 2.5 mm, 2.3 m long	806625231

OPTICAL FORCEPS

FOR BRONCHOSCOPE TUBE AND Ø 3.4 MM TELESCOPE





	WL	Inner Ø	Height	Matching bronchoscope tubes	Matching telescope	Product no.	
Pike-mouth grasping forceps Ø 3.5 mm TL 420 mm Jaw section curved upward 	359 mm	3.5 mm	5.5 mm			8464.61	
Biopsy forceps Ø 3.5 mm TL 420 mm with double spoon jaw 	359 mm	3.5 mm	5.5 mm			Hemer model 8214.1241 (ID 12.0) 8241.1281 (ID 12.0) 8214.1441 (ID 14.0)	8464.63
Biopsy forceps Ø 3.5 mm TL 420 mm with retrograde spoon jaw 	359 mm	3.5 mm	5.5 mm			Pediatric bronchoscope tubes 82510.5530 (ID 5.7) 82514.6030 (ID 6.2) 82510.6035 (ID 6.2) 82510.65351 (ID 6.7) 82514.65351 (ID 6.7)	8464.30 8464.64
Opt. grasping forceps WL 358 mm Straight jaw section  for soft foreign bodies	358 mm	3.4 mm	5.4 mm			82530.0404	
Opt. universal forceps WL 358 mm Jaw section curved upward 	358 mm	3.4 mm	5.4 mm			82530.0405	

OPTICAL FORCEPS

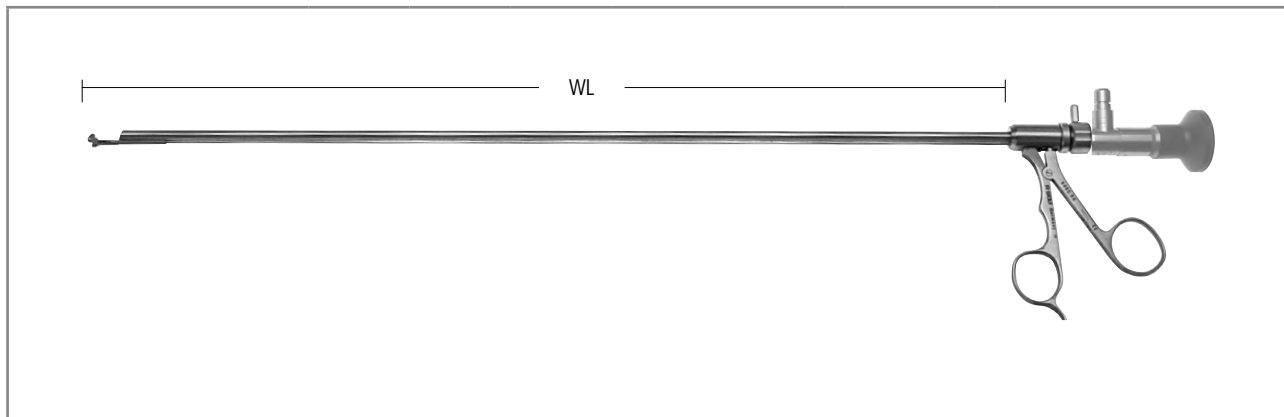
FOR BRONCHOSCOPE TUBE AND Ø 4.0 MM TELESCOPE



	WL	Inner Ø	Height	Matching bronchoscope tubes	Matching telescope	Product no.
Opt. grasping forceps WL 473 mm Jaw section curved upward 	473 mm	5.6 mm	8.4 mm	Hemer model 8214.0841 (ID 8.5) 8214.0941 (ID 9.5) 8214.1041 (ID 10.5) 8214.1241 (ID 12.0) 8214.1261 (ID 12.0) 8241.1281 (ID 12.0) 8214.1441 (ID 14.0) Wolf model 8214.0821 (ID 8.5) 8214.0921 (ID 9.5) 8214.1021 (ID 10.5)	8465.30	8465.61
Opt. biopsy forceps WL 472 mm Straight jaw section 	472 mm	5.6 mm	8.4 mm			8465.63
Opt. biopsy forceps WL 473 mm Jaw section retrograde 	473 mm	5.6 mm	8.4 mm			8465.64





OPTICAL FORCEPS

1.6

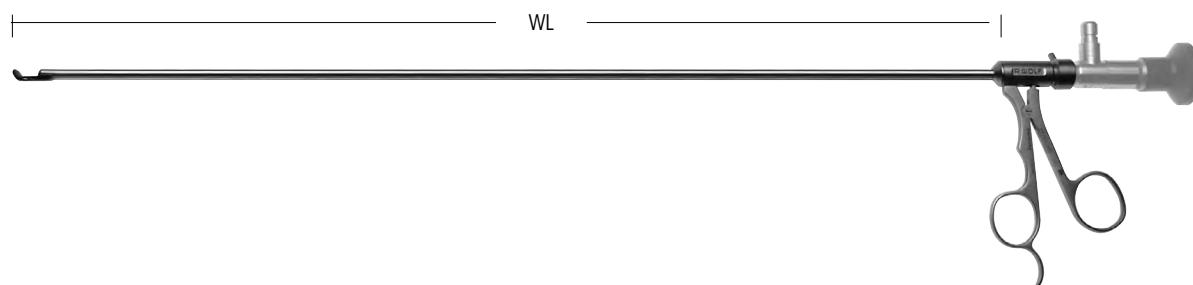
OPTICAL FORCEPS

FOR BRONCHOSCOPE TUBE AND Ø 4.0 MM TELESCOPE







	WL	Inner Ø	Height	Matching bronchoscope tubes	Matching telescope	Product no.
Opt. biopsy forceps WL 500 mm Jaw section curved upward 	500 mm	4.1 mm	6.4 mm	Hemer model 8214.0641 (ID 6.5) 8214.0741 (ID 7.5) 8214.0841 (ID 8.5) 8214.0941 (ID 9.5) 8214.1041 (ID 10.5) 8214.1241 (ID 12.0) 8214.1261 (ID 12.0) 8241.1281 (ID 12.0) 8214.1441 (ID 14.0) Wolf model 8214.0721 (ID 7.5) 8214.0821 (ID 8.5) 8214.0921 (ID 9.5) 8214.1021 (ID 10.5) Pediatric bronchoscope tubes 82510.65351 (ID 6.7) 82514.65351 (ID 6.7)	82514.431	82530.0701
Opt. biopsy forceps WL 498 mm Jaw section retrograde and curved upward 	498 mm	4.1 mm	6.4 mm			82530.0702
Opt. grasping forceps WL 500 mm Jaw section curved upward 	500 mm	4.1 mm	6.4 mm			82530.0703
Opt. grasping forceps WL 504 mm Straight jaw section 	504 mm	4.1 mm	6.4 mm			82530.0704
Opt. grasping forceps WL 500 mm Jaw section curved upward 	500 mm	4.1 mm	6.4 mm			82530.0705

V124 || Subject to modifications. Please note that some products may not be available in all countries. Please always take note of the information that is provided with the product. For more detailed information, please consult with your contact partner or directly with Richard Wolf GmbH.

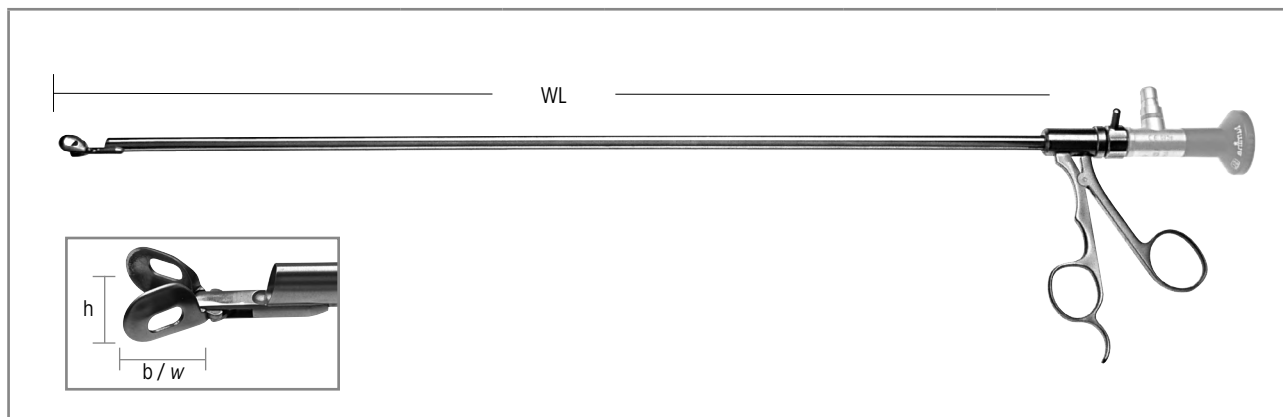
OPTICAL FORCEPS

FOR BRONCHOSCOPE TUBE AND Ø 5.5 MM TELESCOPE





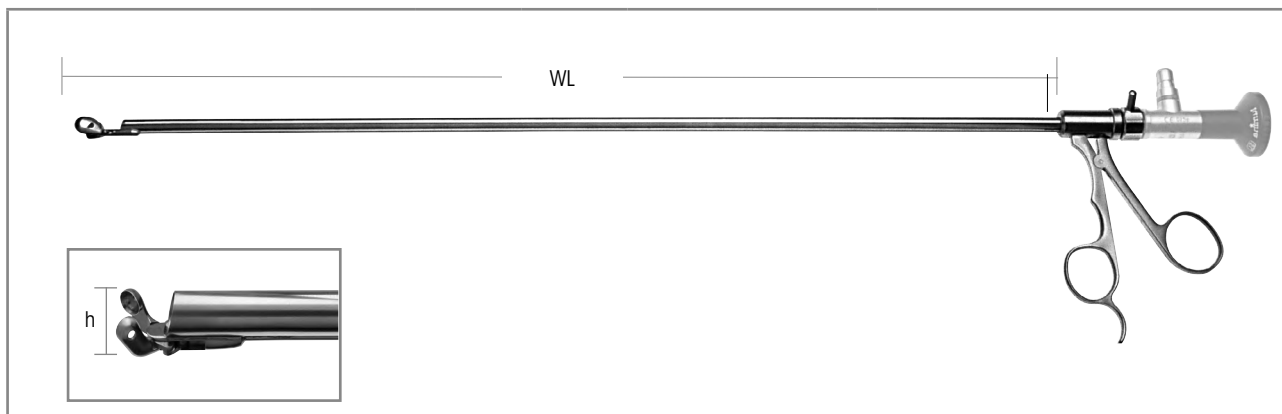

	WL	Inner Ø	Height	Matching bronchoscope tubes	Matching telescope	Product no.
Opt. biopsy forceps WL 474 mm Reichle, straight jaw section Bagger XL 	474 mm	5.6 mm	8.5 mm	Hemer model 8214.0941 (ID 9.5) 8214.1041 (ID 10.5) 8214.1241 (ID 12.0) 8214.1261 (ID 12.0) 8241.1281 (ID 12.0) 8214.1441 (ID 14.0) Wolf model 8214.0921 (ID 9.5) 8214.1021 (ID 10.5)	8465.30	8466.651
Opt. biopsy forceps WL 478 mm Reichle, straight jaw section Bagger XXL 	478 mm	5.6 mm	9.0 mm			8466.652
Opt. grasping forceps WL 479 mm Reichle, straight jaw section Grasper XXL 	479 mm	4.1 mm	8.4 mm			8466.653
Opt. grasping forceps WL 482 mm Straight jaw section Grasper 3XL 	482 mm	5.7 mm	∅ 10.5 mm			8466.654

OPTICAL FORCEPS

FOR BRONCHOSCOPE TUBE AND Ø 5.5 MM TELESCOPE







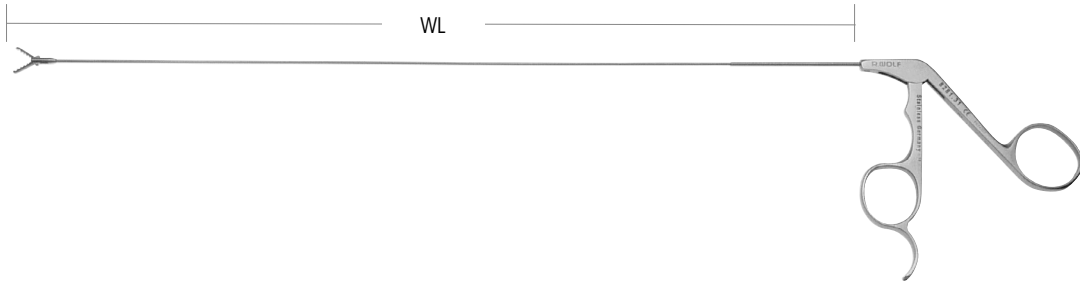

	WL	Inner Ø	Height	Matching bronchoscope tubes	Matching telescope	Product no.
Opt. biopsy forceps WL 462 mm Jaw section curved upward 	462 mm	5.6 mm	8.4 mm			82530.0601
Opt. biopsy forceps WL 462 mm Jaw section retrograde and curved upward 	462 mm	5.6 mm	8.4 mm	Hemer model 8214.0841 (ID 8.5) 8214.0941 (ID 9.5) 8214.1041 (ID 10.5) 8214.1241 (ID 12.0) 8214.1261 (ID 12.0) 8241.1281 (ID 12.0) 8214.1441 (ID 14.0)	8465.30	82530.0602
Opt. grasping forceps WL 469 mm Straight jaw section  for soft foreign bodies	469 mm	5.6 mm	8.4 mm	Wolf model 8214.0821 (ID 8.5) 8214.0921 (ID 9.5) 8214.1021 (ID 10.5)		82530.0604
Opt. universal forceps WL 464 mm Jaw section curved upward 	464 mm	5.6 mm	8.4 mm			82530.0605

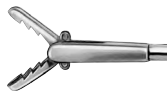
V124 || Subject to modifications. Please note that some products may not be available in all countries. Please always take note of the information that is provided with the product. For more detailed information, please consult with your contact partner or directly with Richard Wolf GmbH.



BRONCHOSCOPE FORCEPS





For bronchoscope tubes with inner Ø		≥ 6 mm	4 mm	≤ 4 mm	Product no.
	Grasping forceps WL 465 mm serrated	•			8280.41
	Foreign body grasping forceps Ø 3 mm serrated, TL 450 mm		•		8281.311
	Universal forceps WL 465 mm serrated	•			8280.42
	Biopsy forceps WL 460 mm smooth	•			8280.43
	Biopsy forceps WL 335 mm smooth			•	8281.33
	Spoon forceps WL 460 mm smooth	•			8280.44
	Tumor forceps WL 460 mm severing	•			8280.45
	Rotation forceps WL 465 mm for hard foreign bodies	•			8280.46
	Grasping forceps WL 465 mm rippled, for soft foreign bodies	•			8280.47
	Grasping forceps WL 365 mm rippled, for soft foreign bodies		•		8281.37
	Grasping forceps WL 330 mm rippled, for soft foreign bodies			•	8282.37
	Biopsy forceps WL 360 mm			•	8282.33

AUXILIARY INSTRUMENTS

ACCESSORIES FOR SUCTION AND IRRIGATION

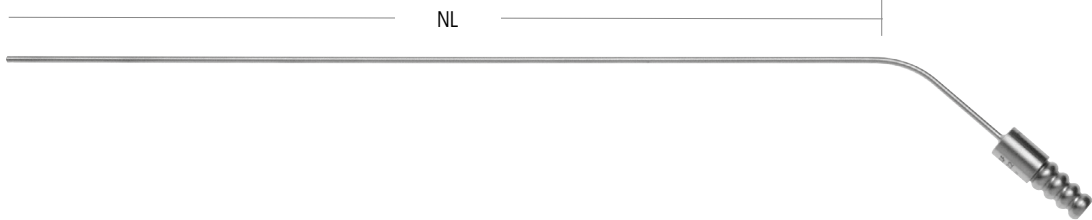
		Ø	WL	Product no.
	Cotton swabs Ø 3.0 mm WL 350 mm	3.0 mm	350 mm	8295.35
	Cotton swabs Ø 3.0 mm WL 500 mm		500 mm	8295.50
	Cotton applicator Ø 3.4 mm WL 490 mm	3.4 mm	490 mm	8296.51

		Outer Ø	WL	Product no.
				
For suction and irrigation		Outer Ø	WL	Product no.
	Suction tube OD 4 mm WL 500 mm central, lateral openings, rigid	4.0 mm	500 mm	8291.45

		Outer Ø	TL	Product no.
	Hand blower with disposable filter, sterile (PACK = 5 PCS)	49 mm	567 mm	412700

V124 || Subject to modifications. Please note that some products may not be available in all countries. Please always take note of the information that is provided with the product. For more detailed information, please consult with your contact partner or directly with Richard Wolf GmbH.

THORACIC ENDOSCOPY

1 BRONCHOSCOPY

2 PEDIATRIC BRONCHOSCOPY

2.1 PEDIATRIC BRONCHOSCOPE TUBE

2.2 PANOVIEW TELESCOPES

2.3 BRONCHOSCOPE FORCEPS

2.4 ACCESSORIES

3 THORACOSCOPY

4 MEDIASTINOSCOPY

PEDIATRIC BRONCHOSCOPE TUBE MUNICH MODEL WITH PROXIMAL ILLUMINATION

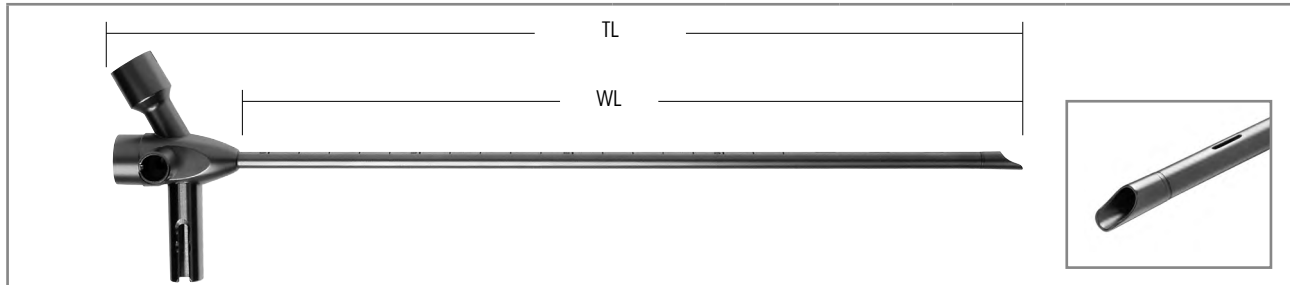

Bronchoscope tube bndl	Inner Ø	Outer Ø	WL	TL	Product no.
For premature babies Bronchoscope tube bndl consisting of: Bronchoscope tube ID 2.8 mm (82514.2716) Sealing cap (8205.13*) and sealing plug TL 25 mm (8256.99**)	2.8 mm	3.4 mm	122 mm	160 mm	82514.27161
For neonates Bronchoscope tube bndl consisting of: Bronchoscope tube ID 3.7 mm (82514.3520) Sealing cap (8205.13*) and sealing plug TL 25 mm (8256.99**)	3.7 mm	4.3 mm	162 mm	200 mm	82514.35201
For newborns and infants Bronchoscope tube bndl consisting of: Bronchoscope tube ID 3.7 mm (82514.3528), sealing cap (8205.13*) and sealing plug TL 25 mm (8256.99**)	3.7 mm	4.3 mm	242 mm	280 mm	82514.35281
For infants Bronchoscope tube bndl consisting of: Bronchoscope tube 4.4 mm (82514.4025), sealing cap (8205.13*), and sealing plug TL 25 mm (8256.99**)	4.4 mm	5.0 mm	210 mm	250 mm	82514.40251

* for the lateral respiration nozzle

** for the proximal lighting socket

Bronchoscope tube individually	Inner Ø	Outer Ø	WL	TL	Product no.
For infants Bronchoscope-tube ID 4,4 mm	4,4 mm	5,0 mm	262 mm	300 mm	82514.4030
For infants / small children Bronchoscope-tube ID 4,7 mm	4,7 mm	5,3 mm	212 mm	250 mm	82514.4525
For infants / small children Bronchoscope-tube ID 4,7 mm ohne distale Schlitzte	4,7 mm	5,3 mm	212 mm	250 mm	82514.4524
For small children Bronchoscope-tube ID 4,7 mm	4,7 mm	5,3 mm	262 mm	300 mm	82514.4530
For small children Bronchoscope-tube ID 5,2 mm	5,2 mm	5,8 mm	262 mm	300 mm	82514.5030
For children under 10 years Bronchoscope-tube ID 6,2 mm	6,2 mm	6,8 mm	262 mm	300 mm	82514.6030
For children over 10 years Bronchoscope-tube ID 6,7 mm	6,7 mm	7,3 mm	312 mm	350 mm	82514.6535
also: (sealing cap and sealing plug must be ordered separately)					
Sealing cap or the lateral respiration nozzle					8205.13
Sealing plug TL 25 mm for the proximal lighting socket					8256.99

PEDIATRIC BRONCHOSCOPE TUBE NICOLAI-MANTEL WITHOUT PROXIMAL ILLUMINATION

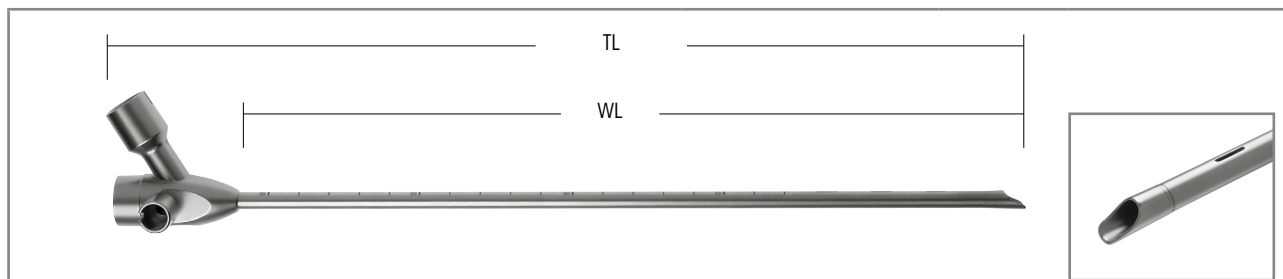

	Inner Ø	Outer Ø	WL	TL	Product no.
For premature babies Bronchoscope tube bndl consisting of: Bronchoscope tube ID 3.2 mm (82510.3016) and sealing cap (8205.13*)	3.2 mm	3.8 mm	122 mm	160 mm	82510.30161
For premature babies Bronchoscope tube bndl consisting of: Bronchoscope tube ID 3.2 mm (82510.3028) and sealing cap (8205.13*)	3.2 mm	3.8 mm	242 mm	280 mm	82510.30281
For neonates Bronchoscope tube bndl consisting of: Bronchoscope tube ID 3.7 mm (82510.3520) and sealing cap (8205.13*)	3.7 mm	4.3 mm	162 mm	200 mm	82510.35201
For newborns and infants Bronchoscope tube bndl consisting of: Bronchoscope tube ID 3.7 mm (82510.3528) and sealing cap (8205.13*)	3.7 mm	4.3 mm	242 mm	280 mm	82510.35281
For infants Bronchoscope tube bndl consisting of: Bronchoscope tube ID 4.4 mm (82510.4025) and sealing cap (8205.13*)	4.4 mm	5.0	212 mm	250 mm	82510.40251
For infants Bronchoscope tube bndl consisting of: Bronchoscope tube ID 4.4 mm (82510.4030) and sealing cap (8205.13*)	4.4 mm	5.0	262 mm	300 mm	82510.40301
For infants Bronchoscope tube bndl consisting of: Bronchoscope tube ID 4.7 mm (82510.4530) and sealing cap (8205.13*)	4.7 mm	5.3	262 mm	300 mm	82510.45301

* for the lateral respiration nozzle.

Matching adapter for telescope		
Matching Bronchoscope tube bndl	82510.40301 82510.45301	
Matching Telescope 0° Ø 3.4 mm WL 378 mm	8464.30	
Adapter for telescope TL 98 mm	8215.711	

PEDIATRIC BRONCHOSCOPE TUBE NICOLAI-MANTEL WITHOUT PROXIMAL ILLUMINATION

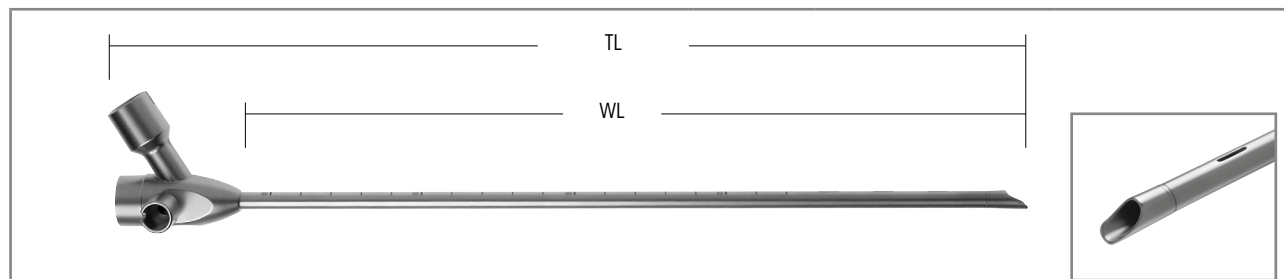

	Inner Ø	Outer Ø	WL	TL	Product no.
For infants and small children Bronchoscope tube bndl consisting of: Bronchoscope tube ID 4.7 mm (82510.4525) and sealing cap (8205.13*)	4.7 mm	5.3 mm	210 mm	250 mm	82510.45251
For infants and small children Bronchoscope tube bndl , distal, without slits, consisting of: Tracheoscope tube ID 4.7 mm (82510.4524) and sealing cap (8205.13*)	4.7 mm	5.3 mm	210 mm	250 mm	82510.45241
For infants Bronchoscope tube bndl consisting of: Bronchoscope tube ID 5.2 mm (82510.5025) and sealing cap (8205.13*)	5.2 mm	5.8 mm	210 mm	250 mm	82510.50251
For infants Bronchoscope tube bndl consisting of: Bronchoscope tube ID 5.2 mm (82510.5030) and sealing cap (8205.13*)	5.2 mm	5.8 mm	260 mm	300 mm	82510.50301
For children under 10 years of age Bronchoscope tube bndl consisting of: Bronchoscope tube ID 5.7 mm (82510.5530) and sealing cap (8205.13*)	5.7 mm	6.3 mm	260 mm	300 mm	82510.55301
For infants Bronchoscope tube bndl consisting of: Bronchoscope tube ID 6.2 mm (82510.6035) and sealing cap (8205.13*)	6.2 mm	6.8 mm	310 mm	350 mm	82510.60351
For infants Bronchoscope tube bndl consisting of: Bronchoscope tube ID 6.7 mm (82510.6535) and sealing cap (8205.13*)	6.7 mm	7.3 mm	310 mm	350 mm	82510.65351









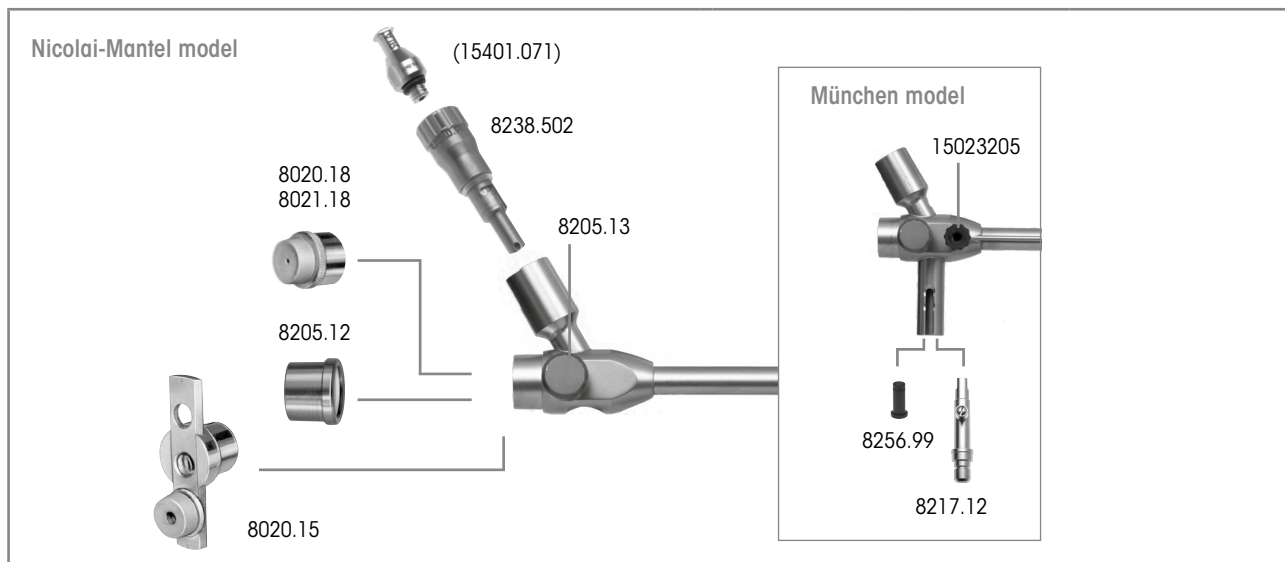



* for the lateral respiration nozzle.

Matching adapter for telescope				
Matching bronchoscope tube bndl	82510.50301 82510.55301	82510.55301	82510.60351 82510.65351	
Matching telescope 0° Ø 3.4 mm WL 378 mm	8464.30			
telescope 0° Ø 5.5 mm WL 488 mm		8465.30	8465.30	
Adapter for telescope TL 98 mm	8215.711			
Adapter for telescope TL 211 mm		8215.713		
Adapter for telescope TL 174 mm			8215.716	

PEDIATRIC BRONCHOSCOPE TUBES

ACCESSORIES AND AUXILIARY INSTRUMENTS



Recommended accessories		Product no.	
	Sealing cap with monitoring window	8205.12	
	Sealing cap (blue)	8205.13	
	Luer sealing cap	15023205	
	Sealing cap for bronchoscope with telescope sealing cap for telescopes Ø 5.5 mm	8020.18	
	Sealing cap for bronchoscope with telescope sealing cap for telescopes Ø 4 mm, 3.4 mm, and 2.7 mm	8021.18	
	Universal cap for bronch.	8020.15	
	Spare telescope sealing caps (Pack=10 PCS)		
	for telescopes Ø 5,5 mm	Sealing cap cap 5.1-6.0 mm	89.03
	for telescopes Ø 4 mm	Sealing cap cap 3.4-5.1 mm	89.02
	for telescopes Ø 2,7 mm and 3,4 mm	Sealing cap cap 2.4-3.4 mm	89.01
 8238.502	Respiration adapter jet ventilation bndl consisting of: Respiration adapter for jet ventilation (8238.502) and Luer connector (15401.071)	8238.5021	
 15401.071			
	Illumination insert	8217.12	
	Endoscope-side adapter for connecting a WOLF light cable to WOLF endoscopes (only with models 82514.xxx in connection with 8217.12)	8095.00	
	Sealing plugs TL 25 mm	8256.99	
	(W x H x D) 500 x 60 x 200 mm	33024	
	Perforated basket for small parts (W x H x D): 128 x 35 x 121 mm	33006	

V124 || Subject to modifications. Please note that some products may not be available in all countries. Please always take note of the information that is provided with the product. For more detailed information, please consult with your contact partner or directly with Richard Wolf GmbH.

TELESCOPE

Ø 2.0 MM, SEMI-RIGID

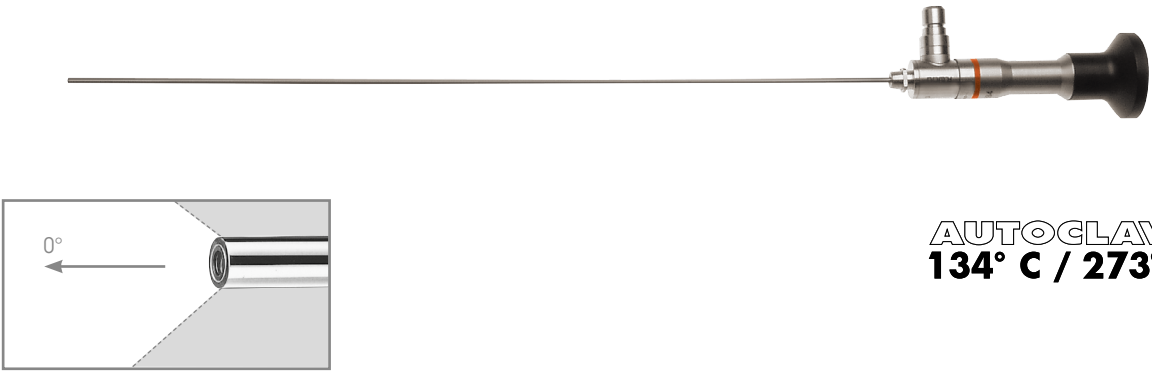

AUTOCLAVE
134° C / 273° F

	Direction of view	WL	TL	Ø	Product no.
Telescope 0° Ø 2 mm WL 296 mm semi-rigid	0°	296 mm	388 mm	2.0 mm	82512.431

Recommended accessories		Product no.
Perforated basket for standard telescope 2	(W x H x D) 481 x 54 x 59 mm	38016
Fiber light cable bndl consisting of: Fiber light cable (80662523), projector-side adapter (8095.07), and endoscope-side adapter (809509)	Ø 2.5 mm, 2.3 m long	806625231

V124 | Subject to modifications. Please note that some products may not be available in all countries. Please always take note of the information that is provided with the product. For more detailed information, please consult with your contact partner or directly with Richard Wolf GmbH.

PANOVIEW TELESCOPE

Ø 2.7 MM FOR PEDIATRIC BRONCHOSCOPES WITH A LENGTH UP TO 160 MM

Ø 4.0 MM FOR PEDIATRIC BRONCHOSCOPES WITH A LENGTH UP TO 160 MM

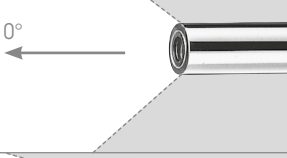
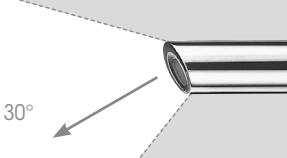
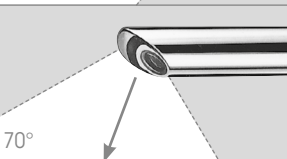
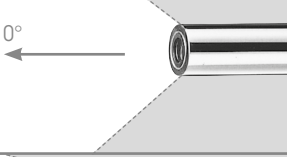
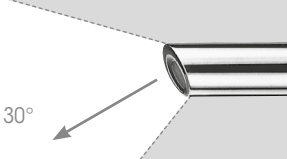
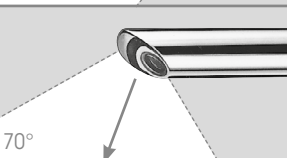

AUTOCLAVE
134° C / 273° F

Direction of view	Ø 2.7 mm	Ø	WL	TL	Product no.
	PANOVIEW Telescope 0° Ø 2.7 mm WL 182 mm	2.7 mm	182 mm	249 mm	8672.421
	PANOVIEW Telescope 30° Ø 2.7 mm WL 182 mm		182 mm	247 mm	8672.422
	PANOVIEW Telescope 70° Ø 2.7 mm WL 185 mm		185 mm	247 mm	8672.425
Direction of view	Ø 4.0 mm	Ø	WL	TL	Product no.
	PANOVIEW Telescope 0° Ø 4 mm WL 298 mm	4.0 mm	298 mm	365 mm	8650.414
	PANOVIEW Telescope 30° Ø 4 mm WL 300 mm		300 mm	247 mm	8654.422
	PANOVIEW Telescope 70° Ø 4 mm WL 302 mm		302 mm	247 mm	8650.415

Recommended accessories		Product no.
Perforated basket for standard telescope 1	(W x H x D) 297 x 54 x 59 mm	38015
Perforated basket for standard telescope 2	(W x H x D) 481 x 54 x 59 mm	38016
Fiber light cable bndl consisting of: Fiber light cable (80662523), projector-side adapter (8095.07), and endoscope-side adapter (809509)	Ø 2.5 mm, 2.3 m long	806625231

PANOVIEW TELESCOPE

Ø 2.7 MM FOR PEDIATRIC BRONCHOSCOPES WITH A LENGTH UP TO 280 MM

Ø 3.4 MM FOR PEDIATRIC BRONCHOSCOPES WITH A LENGTH UP TO 350 MM

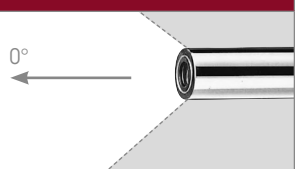

AUTOCLAVE
134° C / 273° F

Direction of view		Ø	WL	TL	Product no.
	PANOVIEW Telescope 0° Ø 2.7 mm WL 310 mm	2.7 mm	310 mm	371 mm	8462.30



AUTOCLAVE
134° C / 273° F

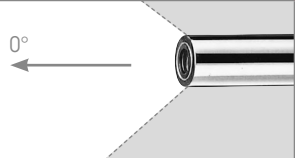

Direction of view		Ø	WL	TL	Product no.
	PANOVIEW Telescope 0° Ø 3.4 mm WL 378 mm	3.4 mm	378 mm	457 mm	8464.30

Recommended accessories		Product no.
Perforated basket for standard telescope 2	(W x H x D) 481 x 54 x 59 mm	38016
Fiber light cable bndl consisting of: Fiber light cable (80662523), projector-side adapter (8095.07), and endoscope-side adapter (809509)	Ø 2.5 mm, 2.3 m long	806625231



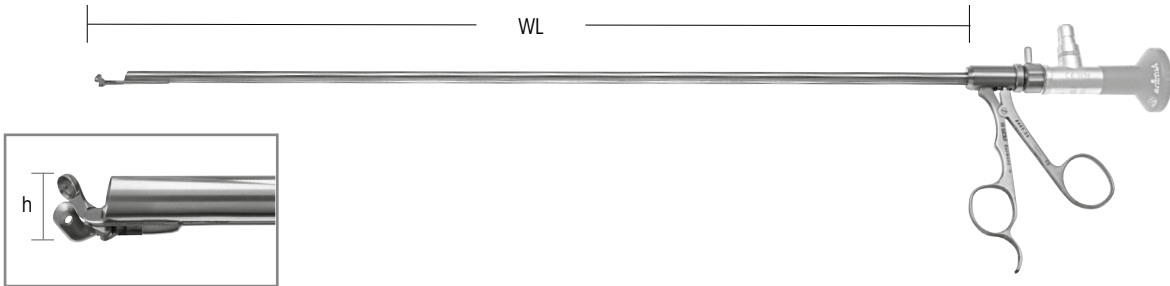



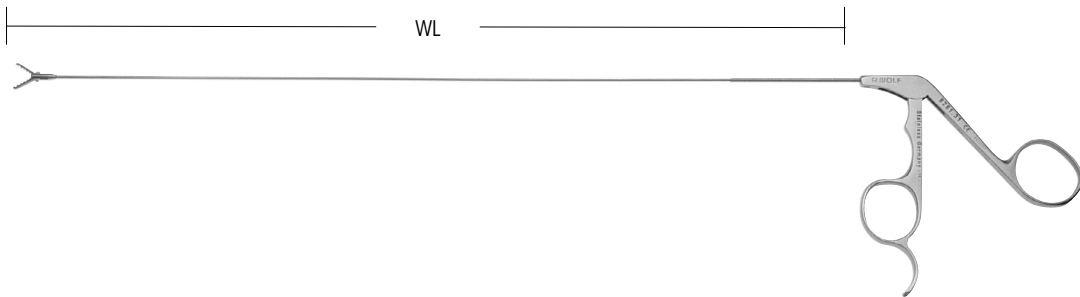

OPTICAL FORCEPS

FOR BRONCHOSCOPE TUBE AND Ø 2.7 / Ø 3.4 MM TELESCOPE

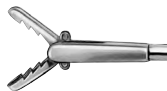

	WL	Inner Ø	Height	Matching bronchoscope tubes	Matching telescope	Product no.
Opt. universal forceps WL 294 mm Jaw section curved upward 	294 mm	2.8 mm	4.7 mm	82510.4524 (ID 4.7) 82510.4525 (ID 4.7) 82510.5025 (ID 5.2)	8462.30	8462.62
Opt. grasping forceps WL 299 mm Straight jaw section 	299 mm	2.8 mm	4.2 mm	82510.4025 (ID 4.4) 82510.4525 (ID 4.7) 82510.4524 (ID 4.7) 82510.5025 (ID 5.2)		8462.64
Pike-mouth grasping forceps Ø 3.5 mm TL 420 mm, curved upward 	359 mm	3.5 mm	5.5 mm	82510.4025 (ID 4.4) 82510.4525 (ID 4.7) 82510.4524 (ID 4.7) 82510.5025 (ID 5.2)	8464.30	8464.61
Biopsy forceps Ø 3.5 mm TL 420 mm with double spoon jaw 	359 mm	3.5 mm	5.5 mm	82510.5530 (ID 5.7) 82510.6030 (ID 6.2) 82510.6035 (ID 6.2) 82510.6535 (ID 6.7)		8464.63
Biopsy forceps Ø 3.5 mm TL 420 mm with retrograde double spoon jaw 	359 mm	3.5 mm	5.5 mm			8464.64
Opt. grasping forceps WL 358 mm Straight jaw section 	358 mm	3.4 mm	5.5 mm	82510.5530 (ID 5.7) 82510.6030 (ID 6.2) 82510.6035 (ID 6.2) 82510.6535 (ID 6.7)	82530.0404	
Opt. universal forceps WL 358 mm Jaw section curved upward 	355 mm	3.4 mm	5.5 mm		82530.0405	

BRONCHOSCOPE FORCEPS

		For bronchoscope tubes with inner Ø			Product no.
		≥ 6 mm	4 mm	≤ 4 mm	
					
	Grasping forceps WL 465 mm serrated	●			8280.41
	Foreign body grasping forceps Ø 3 mm serrated, TL 450 mm		●		8281.311
	Universal forceps WL 465 mm serrated	●			8280.42
	Biopsy forceps WL 460 mm smooth	●			8280.43
	Biopsy forceps WL 335 mm smooth			●	8282.33
	Spoon forceps WL 460 mm smooth	●			8280.44
	Tumor forceps WL 460 mm severing	●			8280.45
	Rotation forceps WL 465 mm for hard foreign bodies	●			8280.46
	Grasping forceps WL 465 mm rippled, for soft foreign bodies	●			8280.47
	Grasping forceps WL 365 mm rippled, for soft foreign bodies		●		8281.37
	Grasping forceps WL 330 mm rippled, for soft foreign bodies			●	8282.37
	Biopsy forceps WL 360 mm			●	8281.33

ACCESSORIES



FOR PEDIATRIC BRONCHOSCOPE TUBES



		WL	Product no.
	Magnetic extractor WL 510 mm for removing magnetizable foreign bodies	510 mm	8250.01





		WL	Product no.
	Extractor WL 470 mm for removing soft foreign bodies that are hard to grasp (miniature corkscrew)	470 mm	8250.10

		Ø	WL	Product no.
	Cotton swabs Ø 3.0 mm WL 350 mm	3.0 mm	350 mm	8295.35
	Cotton swabs Ø 3.0 mm WL 500 mm		500 mm	8295.50
	Cotton applicator Ø 3.4 mm WL 490 mm	3.4 mm	490 mm	8296.51

ACCESSORIES









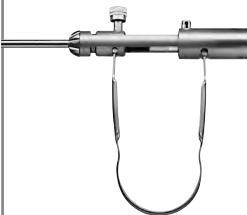

FOR SUCTION AND IRRIGATION

		Outer Ø	TL	Product no.
	Hand blower with disposable filter, sterile (PU = 5 PCS)	49 mm	567 mm	412700





For suction and irrigation		Outer Ø	WL	Product no.
	Suction tube OD 2 mm WL 250 mm central, lateral openings, rigid	2.0 mm	250 mm	8291.22
	Suction tube OD 2.5 mm WL 250 mm central, lateral openings, rigid	2.5 mm	250 mm	8291.23
	Suction tube OD 3 mm WL 250 mm central, lateral openings, rigid	3.0 mm	250 mm	8291.24
	Suction tube, bipo Ø 3.2 mm WL 240 mm	3.2 mm	240 mm	8298.24
for this:	Bipolar connection cable		See THORAX109/110	

V124 | Subject to modifications. Please note that some products may not be available in all countries. Please always take note of the information that is provided with the product. For more detailed information, please consult with your contact partner or directly with Richard Wolf GmbH.

BIPO HF CONNECTION CABLE 8108XXX

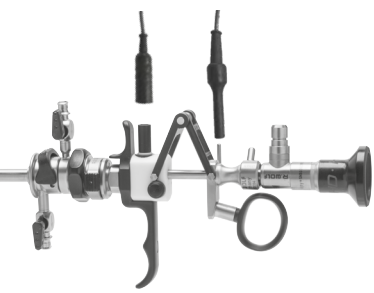
Instrument connector	Device connector		Product no.	
WOLF Bipolar forceps 	 ERBE (ACC/ICC/T)/BOWA (EU) R. Wolf HF surgical generator 400 kHz 2260001/2260002	HF connection cable bipo; L 3 m	8108.032	
		HF connection cable bipo; L 5 m	8108.052	
	 International / 2-pin Valleylab R. Wolf HF surgical generator 400 kHz 2260001/2260002	HF connection cable bipo; L 3 m	8108.033	
		HF connection cable bipo; L 5 m	8108.053	
	 WOLF/Martin (M-version)/ Berchtold/Aesculap	HF connection cable bipo; L 3 m	8108.031	
		HF connection cable bipo; L 5 m	8108.051	
	 EMC Dolley	HF connection cable bipo; L 3 m	8108035	
	Bipolar tweezers connection 	 ERBE (ACC/ICC/T)/BOWA (EU) R. Wolf HF surgical generator 400 kHz 2260001/2260002	HF connection cable bipo; L 3 m	8108.132
			HF connection cable bipo; L 5 m	8108.152
 International / 2-pin Valleylab R. Wolf HF surgical generator 400 kHz 2260001/2260002		HF connection cable bipo; L 3 m	8108.133	
		HF connection cable bipo; L 5 m	8108.153	
 Martin (M-version)/Berchtold/ Aesculap		HF connection cable bipo; L 3 m	8108.131	
		HF connection cable bipo; L 5 m	8108.151	
 EMC Dolley		HF connection cable bipo; L 3 m	8108135	

**HF CONNECTION CABLE BIPO
FOR RESECTION IN SALINE SOLUTION**

Instrument connector	Device connector		Product no.
<p>WOLF S(a)line resectoscopes</p> 	 Erbe VIO 300D	<p>Bipolar cable; TUR/TCR; WOLF</p> <p>MF plug; L 4 m</p>	<p>20196-119</p>
	 Erbe VIO 3	<p>BIPOLAR CABLE; MF-U</p> <p>MF plug; L 4.5 m</p>	<p>21196-119</p>
	 KLS Martin	<p>HF connection cable bipo; L 3 m</p>	<p>8108.231</p>
		<p>HF connection cable bipo; L 5 m</p>	<p>8108.251</p>
	 R. Wolf HF surgical generator 400 kHz 2260001/2260002	<p>HF connection cable bipo; L 3 m</p>	<p>8108233</p>
		<p>HF connection cable bipo; L 5 m</p>	<p>8108253</p>

VI24 || Subject to modifications. Please note that some products may not be available in all countries. Please always take note of the information that is provided with the product. For more detailed information, please consult with your contact partner or directly with Richard Wolf GmbH.

THORACIC ENDOSCOPY

1**BRONCHOSCOPY****2****PEDIATRIC BRONCHOSCOPY****3****THORACOSCOPY****3.1****MINI OR ENDOSCOPE / PANOVVIEW TELESCOPES****3.2****TROCAR SLEEVES****3.3****SURGICAL PROBES / VESSEL CLAMP/PARENCHYMA FORCEPS / LUNG GRASPING FORCEPS****3.4****ERAGONMODULAR INSTRUMENTS****3.5****SCISSORS / TISSUE RETRACTORS****3.6****ACCESSORIES FOR SUCTION AND IRRIGATION****3.7****MULTIFUNCTIONAL SUCTION IRRIGATION SYSTEM****3.8****ELECTRODES****3.9****NEEDLE HOLDERS / KNOT PUSHERS / CANNULAS / SPONGE FORCEPS****3.10****BEE-SYSTEM II BATTERY-POWERED MACHINES****3.11****HF CONNECTION CABLE (MONOPOLAR / BIPOLAR)****4****MEDIASTINOSCOPY**

BASIC SET

MINI THORASCOPY SET

FOR SINGLE-PORT TECHNOLOGY

Product	Product no.	Quantity	Catalog/Section
OR endoscope bndl consisting of:	8920.4011		Thoracic endoscopy / 3
OR endoscope 0° Ø 5.5 mm SL 215 mm	8920.401	1	Thoracic endoscopy / 3
Autom. sealing element ID 5.7 mm 8920.311	8920.311		Thoracic endoscopy / 3
Sealing membrane Ø 17 mm (PU = 10 pcs)	89.103	1	Thoracic endoscopy / 3
Sealing cap, red-orange	15176.020		Thoracic endoscopy / 3
Trocar sleeve straight capacity 5.8 mm WL 62 mm	8905.331	1	Thoracic endoscopy / 3
Trocar tip blunt SZ 5.5 mm WL 80 mm, tip tapered / blunt	8905.3315	1	Thoracic endoscopy / 3
Trocar sleeve, straight, capacity 5.7 mm WL 60 mm	8906.051	1	Thoracic endoscopy / 3
Trocar tip dull SZ 5.5 mm WL 83 mm, tip tapered / blunt	8906.151		Thoracic endoscopy / 3
Double spoon forceps mono Ø 3.5 mm bndl	83912167	1	Thoracic endoscopy / 3
Hook electrode mono Ø 3.5 mm WL 310 mm	8379.452	1	Laparoscopy / Electrodes
Coagulation electrode mono Ø 3.5 mm WL 310 mm	8379.462	1	Laparoscopy / Electrodes
Surgical probe 3.5 mm WL 350 mm	8379.672	1	Laparoscopy / Probes
Saugrohr AD 2,8 mm NL 450 mm	8380.68	1	Thoracic endoscopy / 3
allos:			
Fiber light cable bndl	806625231	1	Thoracic endoscopy / 3
Reprocessing basket	38008	1	Thoracic endoscopy / 3



* Suitable pleurodesis sets are available on the market, e.g. STERITALC PF3 from Novatech

MINI THORACOSCOPE FOR SINGLE PORT TECHNOLOGY

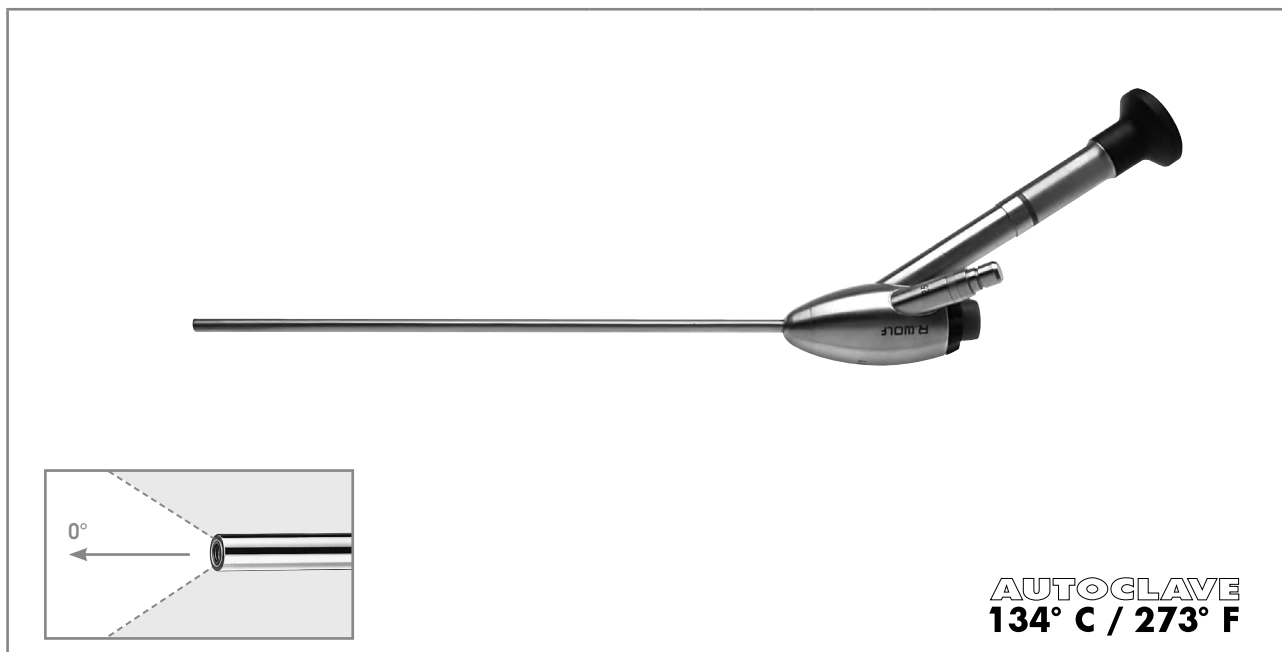
5.5 MM WITH 3.5 MM WORKING CHANNEL

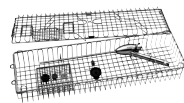

	Direction of view	SL	TL	Ø	Working channel Ø	Product no.
OR endoscope bndl consisting of: OR endoscope 0° Ø 5.5 mm SL 215 mm (8920.401) Autom. sealing element ID 5.7 mm (8920.311) Sealing cap, red-orange (15176.020) Sealing membrane Ø 17 mm (PU = 10 PCS) (89.103)	0°	215 mm	370 mm	5.5 mm	3.5 mm	8920.4011

Recommended accessories		Product no.
Trocar sleeve straight capacity 5.8 mm WL 62 mm		8905.331
also: Trocar tip blunt SZ 5.5 mm WL 80 mm tip tapered / blunt		8905.3315
Trocar sleeve, straight, capacity 5.7 mm WL 60 mm		8906.051
also: Trocar tip dull SZ 5.5 mm WL 83mm, tip tapered / blunt		8906.151
Perforated basket for telescope Dimensions (W x L x H): 132 x 467 x 75 mm		38008
Fiber light cable bndl consisting of: Fiber light cable (80663523), projector-side adapter (8095.07), and endoscope-side adapter (809509)	Ø 3.5 mm, 2.3 m long	806635231

PANOVIEW TELESCOPE Ø 4.0 mm
OPTICAL FORCEPS FOR PANOVIEW TELESCOPE

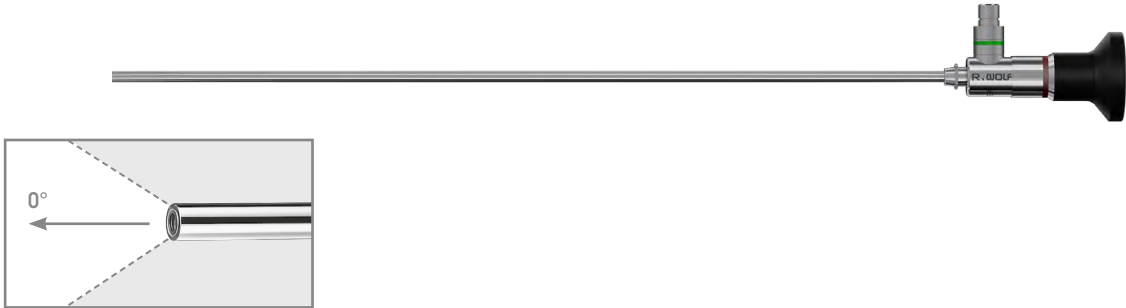

	Direction of view	WL	TL	Ø	Product no.
PANOVIEW Telescope 0° Ø 4 mm WL 289 mm	0°	298 mm	365 mm	4.0 mm	8650.414

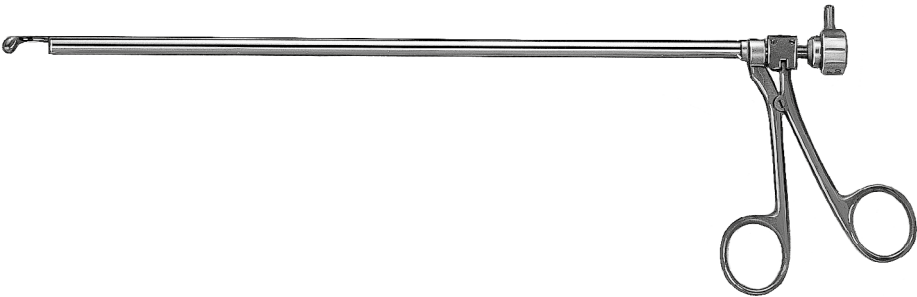

		Outer Ø	WL	Product no.
	Opt. grasping forceps Ø 7 mm WL 281 mm smooth, with double spoon jaw	7.0 mm	281 mm	8913.60

Recommended accessories		Product no.
Perforated basket for standard telescope 2	(W x H x D) 481 x 54 x 59 mm	38016
Fiber light cable bndl consisting of: Fiber light cable (80662523), projector-side adapter (8095.07), and endoscope-side adapter (809509)	Ø 2.5 mm, 2.3 m long	806625231

PANOVIEW TELESCOPE Ø 5.3 MM



free of distortion

full screen

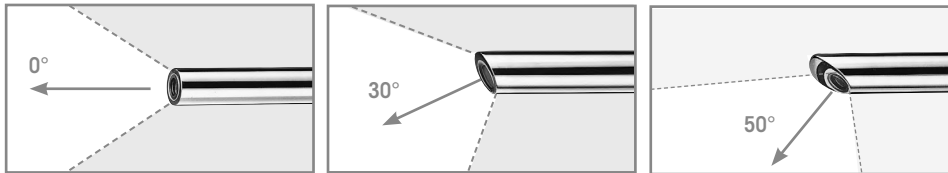
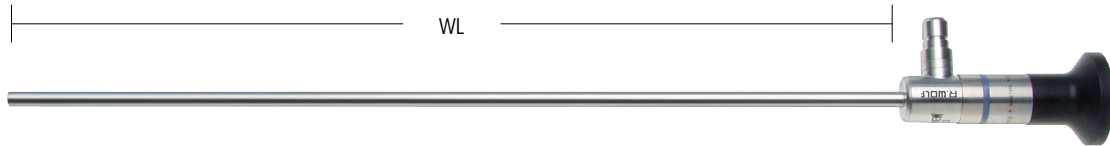

AUTOCLAVE
134° C / 273° F

	Direction of view	WL	TL	Ø	Product no.
PANOVIEW Telescope 0° Ø 5.3 mm WL 303 mm	0°	303 mm	372 mm	5.3 mm	8935.441
PANOVIEW Telescope 30° Ø 5.3 mm WL 303 mm	30°		373 mm		8935.442
PANOVIEW Telescope 50° Ø 5.3 mm WL 309 mm	50°	309 mm	377 mm		8935.443

Recommended accessories		Product no.
Perforated basket for standard telescope 2	(W x H x D) 481 x 54 x 59 mm	38016
Fiber light cable bndl consisting of: Fiber light cable (80662523), projector-side adapter (8095.07), and endoscope-side adapter (809509)	Ø 2.5 mm, 2.3 m long	806625231

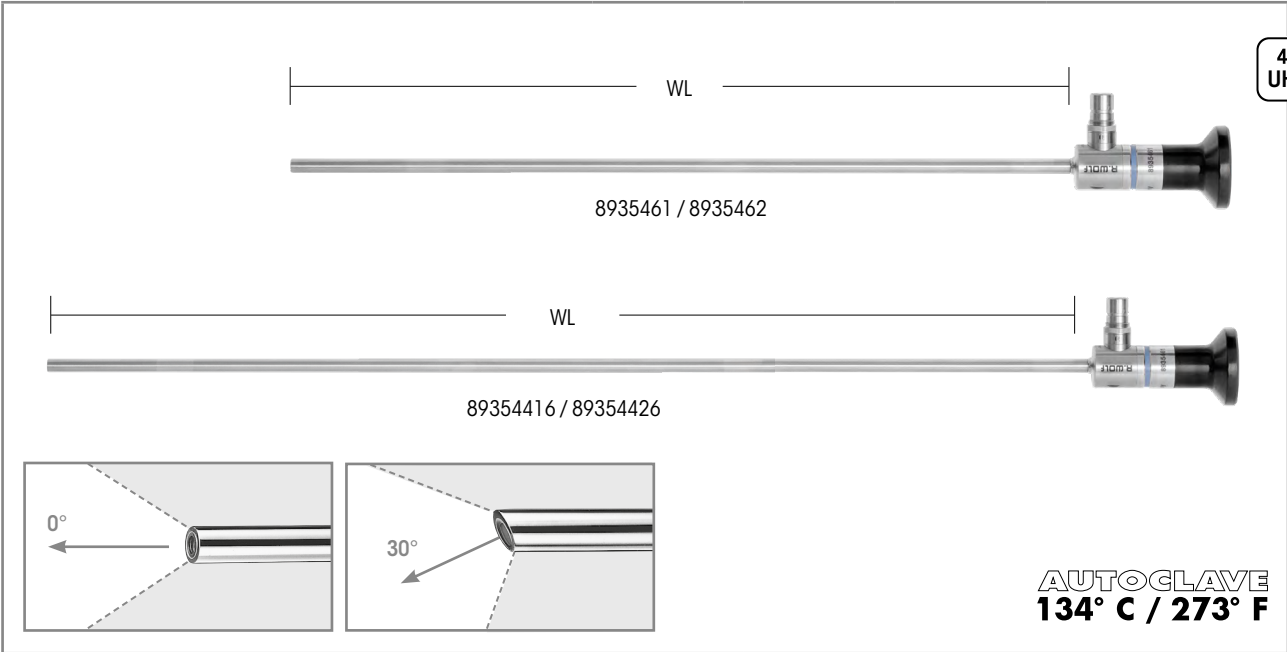

	Direction of view	WL	Ø	Product no.
PANOVIEW ULTRA Telescope Ø 5.5 mm WL 300 mm	0°	300 mm	5.5 mm	8935461
PANOVIEW ULTRA Telescope Ø 5.5 mm WL 300 mm	30°			8935462
PANOVIEW ULTRA Telescope Ø 5.5 mm WL 430 mm	0°	430 mm		89354416
PANOVIEW ULTRA Telescope Ø 5.5 mm WL 430 mm	30°			89354426

Recommended accessories		Product no.
Perforated basket for standard telescope 2 (for telescope 8935416/8935426)	(W x H x D) 481 x 54 x 59 mm	38016
Perforated basket for standard telescope 3 (for telescope 89354416/89354426)	(W x H x D) 619 x 54 x 59 mm	38017
Fiber lightcable bndl consisting of: Fiber light cable Ø 5 mm TL 2.3 m (80665023), projector-side adapter (8095.07), and endoscope-side adapter (809509)	Ø 5.0 mm, 2.3 m long	806650231
Fusion Fiber light cable bndl consisting of: Fiber light cable Ø 5 mm TL 2.3 m (80655023), projector-side adapter (8095.07), and endoscope-side adapter (809509)	Ø 5.0 mm, 2.3 m long	806550231

V124 || Subject to modifications. Please note that some products may not be available in all countries. Please always take note of the information that is provided with the product. For more detailed information, please consult with your contact partner or directly with Richard Wolf GmbH.

PANOVIEW PLUS TELESCOPE Ø 7.0 MM

‡ FREE OF DISTORTION

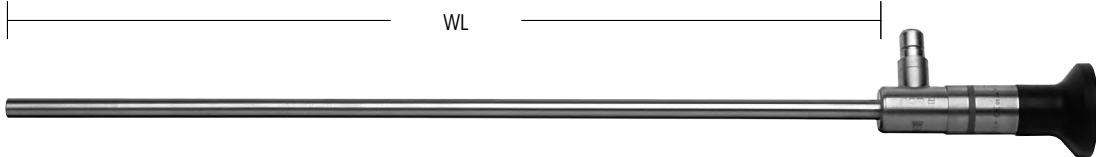

HD
High Definition

AUTOCLAVE
134° C / 273° F

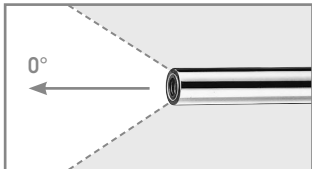
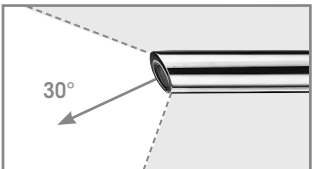
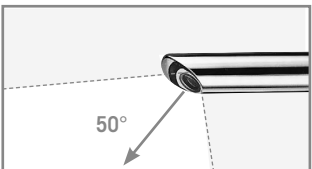
	Direction of view	WL	TL	Ø	Product no.
PANOVIEW PLUS Telescope 0° Ø 7 mm WL 297 mm	0°	297 mm	368 mm	7.0 mm	8933.431
PANOVIEW Telescope 30° Ø 7 mm WL 297 mm	30°		368 mm		8933.432
PANOVIEW Telescope 50° Ø 7 mm WL 300 mm	50°	300 mm	369 mm		8933.433

Recommended accessories	Product no.
Perforated basket for standard telescope 2	(W x H x D) 481 x 54 x 59 mm 38016
Fiber light cable bndl consisting of: Fiber light cable (80662523), projector-side adapter (8095.07), and endoscope-side adapter (809509)	Ø 2.5 mm, 2.3 m long 806625231

PANOVIEW PLUS TELESCOPE Ø 10 MM

≠ FREE OF DISTORTION

≠ free of distortion

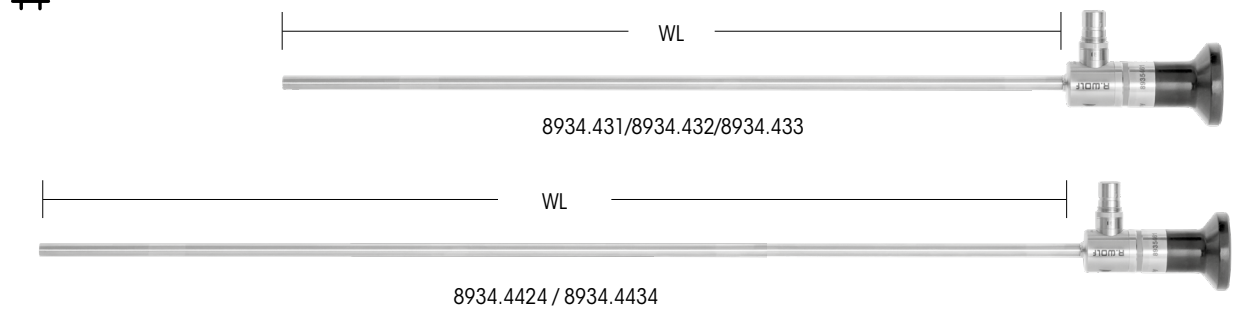
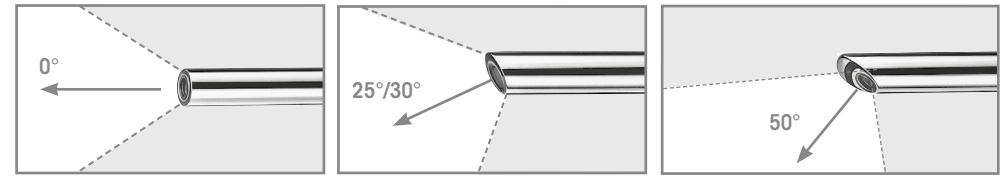
AUTOGLAVE
134° C / 273° F





	Direction of view	WL	TL	Ø	Product no.
PANOVIEW Telescope 0° Ø 10 mm WL 307 mm	0°	307 mm	375 mm	10 mm	8934.431
PANOVIEW Telescope 30° Ø 10 mm WL 307 mm	30°	307 mm	375 mm		8934.432
PANOVIEW Telescope 50° Ø 10 mm WL 310 mm	50°	310 mm	378 mm		8934.433
PANOVIEW PLUS Telescope 25° Ø 10 mm WL 438 mm	25°	438 mm	507 mm		8934.4424
PANOVIEW PLUS Telescope 50° Ø 10 mm WL 447 mm	50°	447 mm	516 mm		8934.4434





Recommended accessories		Product no.
Perforated basket for standard telescope 2 (for telescope 8934.431/432/433)	(W x H x D) 481 x 54 x 59 mm	38016
Perforated basket for standard telescope 3 (for telescope 8934.4424/4434)	(W x H x D) 619 x 54 x 59 mm	38017
Fiber lightcable bndl consisting of: Fiber light cable Ø 5 mm TL 2.3 m (80665023), projector-side adapter (8095.07), and endoscope-side adapter (809509)	Ø 5.0 mm, 2.3 m long	806650231
Fusion Fiber light cable bndl consisting of: Fiber light cable Ø 5 mm TL 2.3 m (80655023), projector-side adapter (8095.07), and endoscope-side adapter (809509)	Ø 5.0 mm, 2.3 m long	806550231

V124 || Subject to modifications. Please note that some products may not be available in all countries. Please always take note of the information that is provided with the product. For more detailed information, please consult with your contact partner or directly with Richard Wolf GmbH.

TROCAR SLEEVE 5.5 MM / 5.8 MM

PLASTIC WITH SEALING MEMBRANE







 <p>AUTOCLAVE 134° C / 273° F</p>					Tip tapered/blunt	Tip tapered/pointed	Tip triangular
							
					Trocar tip blunt SZ 5.5 mm	Trocar tip pointed SZ 5.5 mm	Trocar tip triangular SZ 5.5 mm
Flexible plastic sheath tube with thread	WL	Capacity	with stopcock	Product no.	WL 104 mm	WL 104 mm	WL 104 mm
Trocar sleeve straight capacity 5.5 mm WL 62 mm with membrane valve	62 mm	5.5 mm	●	8919.333	8919.3311	8919.3312	8919.3313
				8919.331			
					WL 144 mm	WL 144 mm	WL 144 mm
Trocar sleeve straight capacity 5.5 mm WL 102 mm with membrane valve	102 mm	5.5 mm	●	8919.353	8919.3511	8919.3512	8919.3513
				8919.351			

 <p>AUTOCLAVE 134° C / 273° F</p>				Tip tapered/blunt	Tip tapered/pointed	Tip triangular	Tip tapered/blunt
							
				Trocar tip blunt SZ 5.5 mm	Trocar tip pointed SZ 5.5 mm	Trocar tip triangular SZ 5.5 mm	Trocar tip blunt SZ 5.5 mm
Flexible plastic sheath tube, with thread	WL	Capacity	Product no.	WL 80 mm	WL 80 mm	WL 80 mm	WL 80 mm
Trocar sleeve straight capacity 5.8 mm WL 62 mm with membrane valve	62 mm	5.8 mm	8905.331	8905.3311	8905.3312	8905.3313	8905.3315
				WL 120 mm	WL 120 mm	WL 120 mm	WL 120 mm
Trocar sleeve straight capacity 5.8 mm WL 102 mm with membrane valve	102 mm	5.8 mm	8905.351	8905.3511	8905.3512	8905.3513	8905.3515



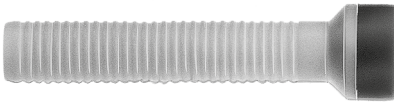



Accessories	Product no.
Sealing membrane Ø 17 mm, yellow (PU = 10 PCS)	89.103
Stopcock insert bndl cap 3.0 mm (PU = 5 PCS)	896.0002

TROCAR SLEEVE 5.7 MM/7 MM/10 MM/15.5 MM

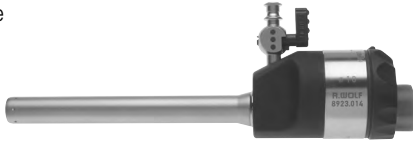
FLEXIBLE PLASTIC SHEATH TUBE

				Tip tapered/blunt	
				Trocar tip blunt	
Flexible plastic sheath tube with thread	WL	Capacity	Product no.	Size 5.5 mm/WL 83 mm	
Trocar sleeve, straight, capacity 5.7 mm WL 60 mm with rubber cap	60 mm	5.7 mm	8906.051	8906.151	
				Tip tapered/blunt	
				Trocar tip blunt	
Ribbed flexible plastic sheath tube	WL	Capacity	Product no.	Size 7.3 mm/TL 108 mm	
Trocar sleeve flexible capacity 7 mm WL 74 mm with universal seal	74 mm	7 mm	8906.001	8913.11	
				Size 10 mm/TL 85 mm	
Trocar sleeve flexible capacity 10 mm WL 56 mm with universal seal	56 mm	10 mm	8906.011	8906.111	
				Size 12.5 mm/TL 86 mm	
Trocar sleeve flexible capacity 12.5 mm WL 57 mm with universal seal	57 mm	12.5 mm	8906.031	8906.131	
				Tip, semi-blunt	
				Trocar tip blunt SZ 13.5 x 18 mm	
Stainless steel sheath tube	WL	Capacity	Product no.	TL 78 mm	
Trocar sleeve cap 13.6 x 18 mm WL 56 mm	56 mm	13.6 x 18 mm	8906.081	8906.181	

TROCAR SLEEVE 10 MM WITH INSUFFLATION STOPCOCK

RIWO-ART trocar sleeves with magnetic ball valve 					Tip tapered/blunt	Tip tapered/pointed	Tip triangular
					Trocar tip blunt SZ 10 mm	Trocar tip pointed SZ 10 mm	Trocar tip triangular SZ 10 mm
Stainless steel sheath tube		WL	Capacity	Product no.	WL 164 mm	WL 164 mm	WL 164 mm
Trocar sleeve straight capacity 10 mm WL 100 mm		100 mm	10 mm	8923.014	8923.103	8923.113	8923.123
Trocar sleeve slanted capacity 10 mm WL 100 mm		100 mm	10 mm	8923.013	8923.103	8923.113	8923.123
Trocar sleeve straight capacity 10 mm WL 100 mm with thread		100 mm	10 mm	8923.024	8923.103	8923.113	8923.123
Trocar sleeve slanted capacity 10 mm WL 100 mm with thread		100 mm	10 mm	8923.023	8923.103	8923.113	8923.123
					WL 214 mm	WL 214 mm	WL 214 mm
Trocar sleeve straight capacity 10 mm WL 150 mm		150 mm	10 mm	8923.016	-	8923.115	8923.125
Trocar sleeve straight capacity 10 mm WL 150 mm with thread		150 mm	10 mm	8923.026	-	8923.115	8923.125

Accessories	Product no.
Spare ball capacity 7 mm	8923.901
Spare O-rings capacity 7 mm (PU = 10 PCS), capacity Ø 7–12.5 mm	8923.951
Sealing cap capacity 9.5–10.1 mm (PU = 10 PCS) red	89.08
Stopcock insert bndl cap. 3.0 mm (PU = 5 PCS)	896.0002

SURGICAL PROBES

SURGICAL PROBES



		Ø	WL	Product no.
	Surgical probe 3.5 mm WL 350 mm graduated	3.5 mm	350 mm	8379.672



		Ø	WL	Product no.
	Surgical probe Ø 5 mm WL 328 mm graduated	5.0 mm	328 mm	8383.66
	Surgical probe Ø 5 mm WL 448 mm graduated	5.0 mm	448 mm	8384.66





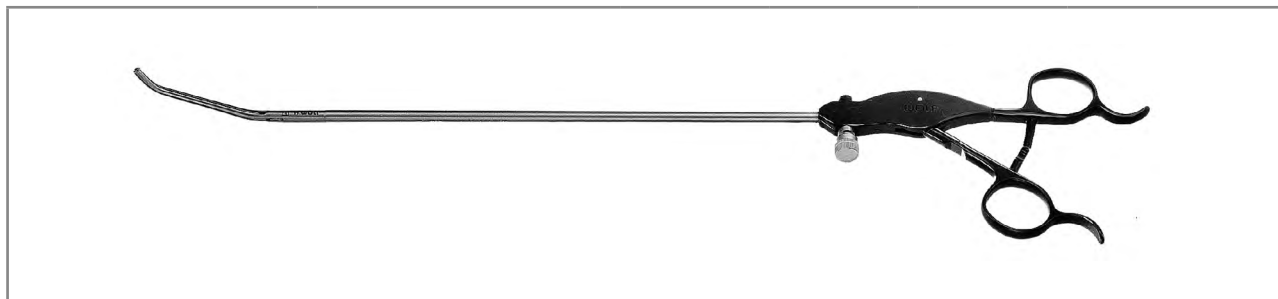

V124 || Subject to modifications. Please note that some products may not be available in all countries. Please always take note of the information that is provided with the product. For more detailed information, please consult with your contact partner or directly with Richard Wolf GmbH.

VESSEL CLAMP / PARENCHYMA FORCEPS 5 MM

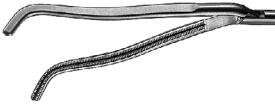
LUNG GRASPING FORCEPS 5 MM

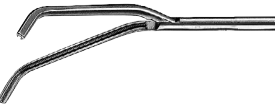
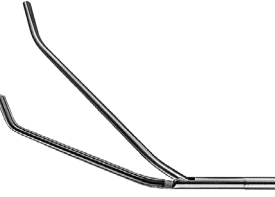
LINDNER

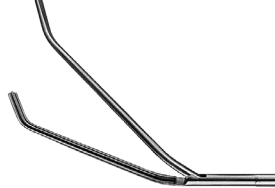

with irrigation connector		Ø	WL	TL	Product no.
	Dimensions: Ø 5 mm jaw section curved to the left	5 mm	260 mm	415 mm	8242.651
	Dimensions: Ø 5 mm jaw section curved to the right				8242.652
	Parenchyma forceps Ø 5 mm WL 270 mm 30 mm curved to the left	5 mm	270 mm	402 mm	8242.601
	Parenchyma forceps Ø 5 mm WL 270 mm 30 mm curved to the right				8242.602
	Parenchyma forceps Ø 5 mm WL 280 mm 50 mm curved to the left	5 mm	280 mm	412 mm	8242.603
	Parenchyma forceps Ø 5 mm WL 280 mm jaw section curved to the right				8242.604
	Lung grasping forceps WL 270 mm angled	5 mm	270 mm	402 mm	8242.611

ERAGON^{modular}

THE LAPAROSCOPIC TOOLBOX

The toolbox principle

ERAGONmodular offers surgeons every possible way of creating their dream set of laparoscopic instruments. Ergonomic handles, all practical diameters, useful working lengths, and a diverse range of jaw parts can be combined in any configuration. This universal compatibility also ensures that individual trays can comprise just a few instruments – for more efficiency and one way of cutting costs.

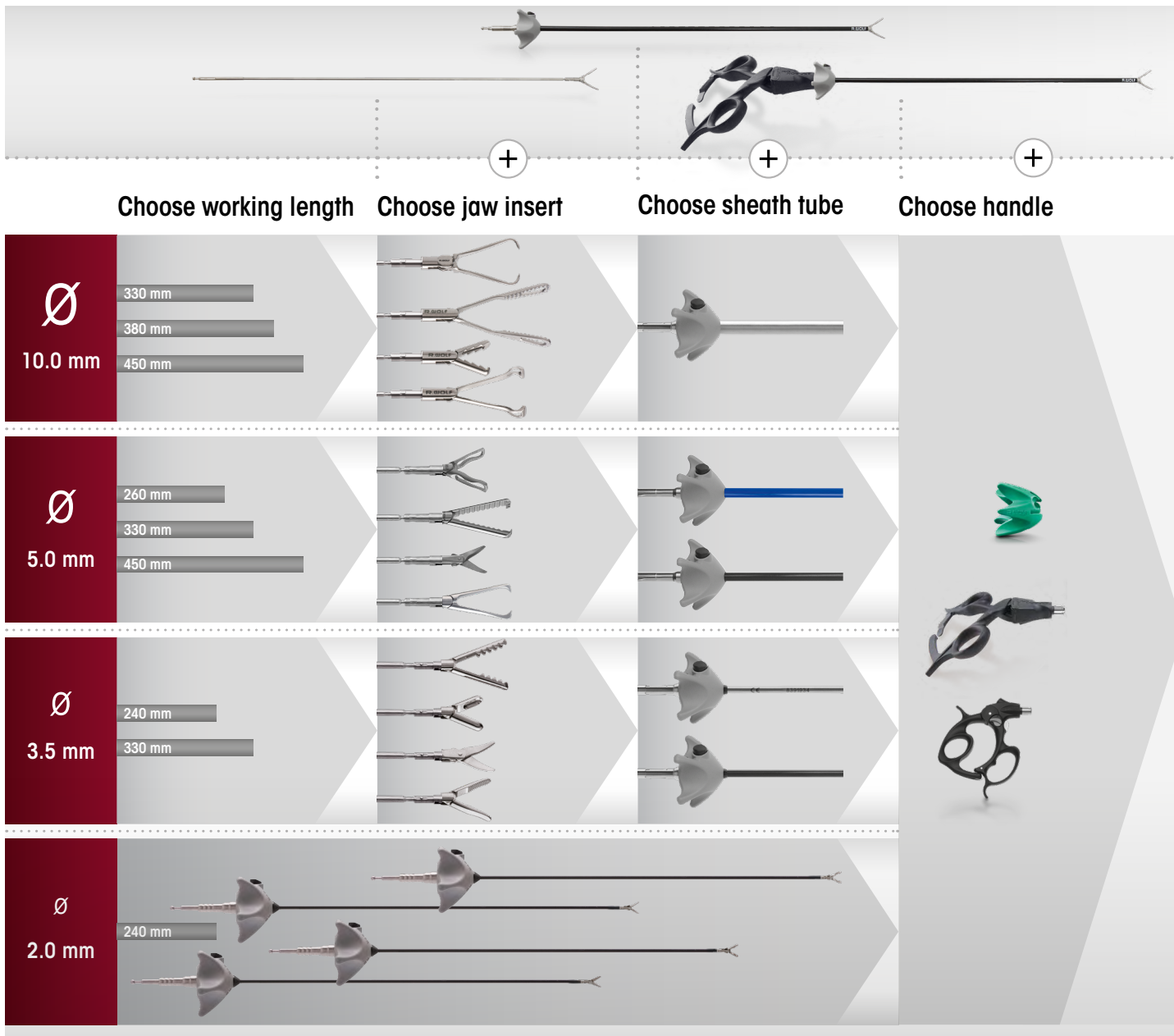

ERAGONMODULAR

3.4



Complete instrument/tray

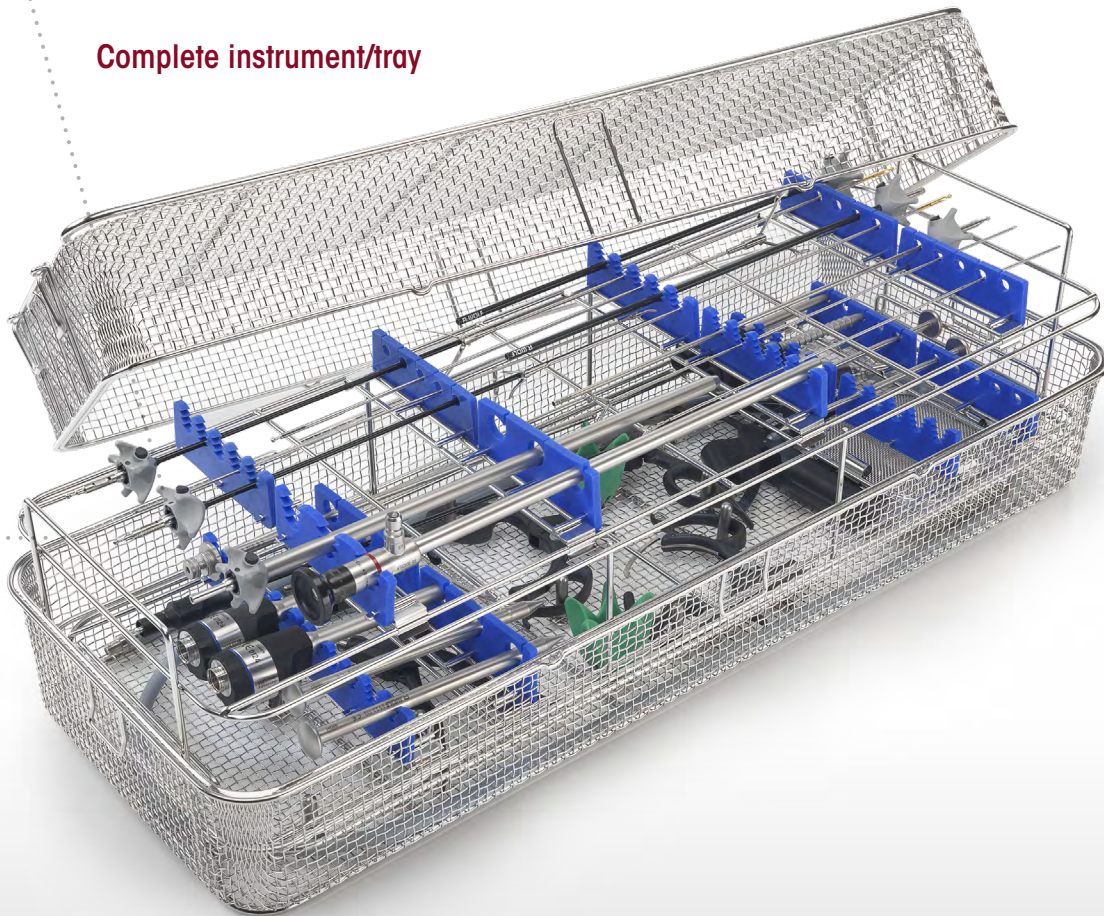

ERAGON modular

THE ERGONOMIC GENERATION OF NEEDLE HOLDERS

Thanks to the custom combination options it offers, **ERAGONstitch** can accommodate any user requirement. The way in which it brings together ergonomics, versatility, modularity, and precision sets new standards in comfort.

ERAGONMODULAR

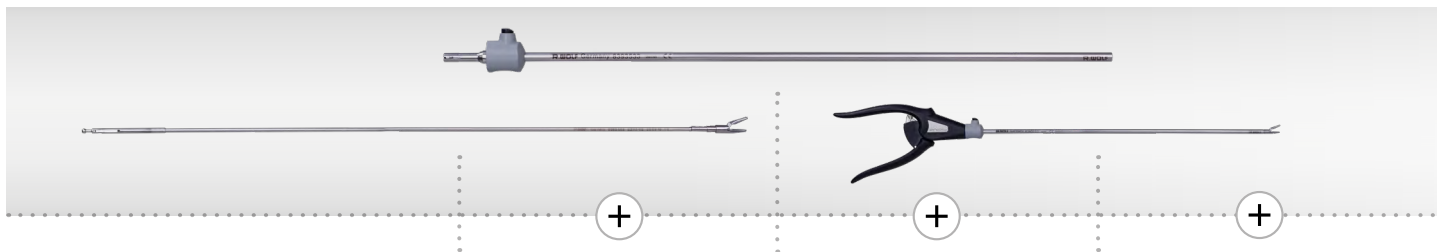

Choose working length

Choose jaw insert

Choose sheath tube

Choose handle

3.4

<p>Ø 5.0 mm</p>	<p>330 mm</p> <p>450 mm</p>			
	<p>Ø 3.5 mm</p>	<p>240 mm</p> <p>330 mm</p>		









ERAGONstitch needle holders



ERAGON *modular micro*
Ø 2 MM, INSULATED





ERAGONMODULAR

3.4

		Handle, axial		
ERAGON <i>axial</i>				
All jaw inserts and sheath tubes can also be combined with ERAGON axial.		without lock, with HF connector	without lock, with HF connector	
Rotatable knob	Product no.	83930083	83930084	
	8988	•	•	
Jaw insert		Sheath tube, Ø 2.0 mm, insulated	Handle, pistol-shaped	Complete instrument
				<ul style="list-style-type: none"> • Jaw insert with sheath tube • Handle
		WL 240 mm	without lock, with HF, mono	
	JL*	Product no.	83930073	Product no.
	7 mm	8388200	•	83882007
Scissors mono Ø 2 mm bndl straight, double-action				
	7 mm	8388201	•	83882017
Dissector forceps mono Ø 2 mm bndl straight, double-action				
	7 mm	8388202	•	83882027
Atraumat. grasping forceps mono Ø 2 mm bndl fenestrated, double-action				

* JL = jaw length when jaw section closed (approximate measurements)
HF connection cable: see page THORAX105/106

ERAGON modular
micro
Ø 2 MM, INSULATED

Jaw insert			Sheath tube, Ø 2.0 mm, insulated	Handle, pistol-shaped	Complete instrument • Jaw insert with sheath tube • Handle
					
			WL 240 mm	with lock, with HF, mono	
	JL*	Product no.		83930074	Product no.
 Grasping forceps mono Ø 2 mm bndl double-action	7 mm	8388203	•	•	83882037

* JL = jaw length when jaw section closed (approximate measurements)
 HF connection cable: see page THORAX105/106



Accessories for manual and machine reprocessing		Product no.
	Irrigation adapter Ø 9 mm, length 64 mm	163502







ERAGON modular mini

Ø 3.5 MM, INSULATED

ERAGONMODULAR

3.4

		Handle, axial	
ERAGON axial			
All jaw inserts and sheath tubes can also be combined with ERAGONaxial.		without lock, with HF connector	without lock, with HF connector
Rotatable knob	Product no.	83930083	83930084
	8988	.	.

Jaw insert		Sheath tube, Ø 3.5 mm, insulated		Handle, pistol-shaped	Complete instrument	
					<ul style="list-style-type: none"> • Jaw insert with sheath tube • Handle 	
		WL 240 mm	WL 330 mm	with lock, with HF, mono		
	JL*	Product no.	8390933	8391933	83930074	Product no.
	15 mm	8390207	.	.	.	83902077
curved to the left, double-action		8391207	.	.	.	83912077
	18 mm	8390221	.	.	.	83902217
long, fine tip, double-action		8391221	.	.	.	83912217
	14 mm	8390222	.	.	.	83902227
short, fine tip, double-action		8391222	.	.	.	83912227
	14 mm	8390223	.	.	.	83902237
angled, double-action		8391223	.	.	.	83912237









* JL = jaw length when jaw section closed (approximate measurements)

HF connection cable: see page THORAX105/106

V124 || Subject to modifications. Please note that some products may not be available in all countries. Please always take note of the information that is provided with the product. For more detailed information, please consult with your contact partner or directly with Richard Wolf GmbH.

ERAGON modular mini

Ø 3.5 MM, INSULATED





Jaw insert			Sheath tube, Ø 3.5 mm, insulated		Handle, pistol-shaped		Complete instrument • Jaw insert with sheath tube • Handle
							
			WL 240 mm	WL 330 mm	without lock, with HF, mono	with lock, with HF, mono	
	JL*	Product no.	8390933	8391933	83930073	83930074	Product no.
 Metzenbaum scissors mono Ø 3.5 mm bndl double-action	16 mm	8390215	•		•		83902157
		8391215			•		83912157
 Metzenbaum scissors mono Ø 3.5 mm bndl fine-toothed, curved, double-action	14 mm	8390224	•		•		83902247
		8391224			•		83912247
 Hook scissors mono Ø 3.5 mm bndl single-action	8 mm	8390227	•		•		83902277
		8391227			•		83912277
 Double spoon forceps mono Ø 3.5 mm bndl	12 mm	8390216	•			•	83902167
		8391216			•		83912167
 Friedel punch mono Ø 3.5 mm bndl	10 mm	8390217	•			•	83902177
		8391217			•		83912177







* JL = jaw length when jaw section closed (approximate measurements)

HF connection cable: see page THORAX105/106

Accessories for manual and machine reprocessing		Product no.
	Irrigation adapter Ø 9 mm, length 64 mm	163502







ERAGON modular mini
Ø 3.5 MM, UNINSULATED

		Handle, axial	
 All jaw inserts and sheath tubes can also be combined with ERAGONaxial.			
		with lock, without HF connector	with lock, without HF connector, not rotatable
Rotatable knob	Product no.	83930082	83930085
	8988	.	.

Jaw insert		Sheath tube, Ø 3.5 mm, uninsulated		Handle, pistol-shaped	Complete instrument	
					• Jaw insert with sheath tube • Handle	
		WL 240 mm	WL 330 mm			with lock, without HF
	JL*	Product no.	8390934	8391934	83930072	Product no.
 Atraumat. grasping forceps Ø 3.5 mm bndl fenestrated, double-action	14 mm	8390208	.	.	.	83902087
		8391208	.	.	.	83912087
 Atraumat. grasping forceps Ø 3.5 mm bndl fenestrated, single-action	17 mm	8390218	.	.	.	83902187
		8391218	.	.	.	83912187
 Atraumat. grasping forceps Ø 3.5 mm bndl double fenestrated, curved, single-action	17 mm	8390225	.	.	.	83902257
		8391225	.	.	.	83912257
 Atraumat. grasping forceps Ø 3.5 mm bndl fenestrated, double-action	19 mm	8390226	.	.	.	83902267
		8391226	.	.	.	83912267

* JL = jaw length when jaw section closed (approximate measurements)
 HF connection cable: see page Thorax107-108

ERAGON modular mini
Ø 3.5 MM, UNINSULATED







Jaw insert			Sheath tube, Ø 3.5 mm, uninsulated		Handle, pistol-shaped	Complete instrument • Jaw insert with sheath tube • Handle
						
			WL 240 mm	WL 330 mm		with lock, without HF
	JL*	Product no.	8390934	8391934	83930072	Product no.
 Grasping forceps Ø 3.5 mm bndl 13 mm fenestrated, double-action		8390219	•		•	83902197
		8391219		•	•	83912197
 Grasping forceps Ø 3.5 mm bndl 17 mm fenestrated, single-action		8390220	•		•	83902207
		8391220		•	•	83912207
 Universal grasping forceps Ø 3.5 mm bndl 14 mm double-action		8390209	•		•	83902097
		8391209		•	•	83912097
 Babcock forceps Ø 3.5 mm bndl 19 mm double-action		8390210	•		•	83902107
		8391210		•	•	83912107







* JL = jaw length when jaw section closed (approximate measurements)

HF connection cable: see page THORAX105/106

Accessories for manual and machine reprocessing		Product no.
	Irrigation adapter Ø 9 mm, length 64 mm	163503

ERAGON modular
Ø 5.0 MM, INSULATED

		Handle, axial			
					
All jaw inserts and sheath tubes can also be combined with ERAGONaxial.		with lock	without lock, with HF connector	without lock, with HF connector	with lock, not rotatable
Rotatable knob	Product no.	83930082	83930083	83930084	83930085
	8988	•	•	•	









Jaw insert		Sheath tube, Ø 5.0 mm, insulated		Handle, pistol-shaped	Complete instrument
					<ul style="list-style-type: none"> • Jaw insert with sheath tube • Handle
	JL*	Product no.	SL 330 mm	SL 450 mm	with lock, with HF, mono
					Product no.
	21 mm	8393.281	•	•	83932817
curved, with fine cross toothing, double-action		8394.281		•	83942817
	22 mm	8393.283	•	•	83932837
angled, fine, pyramid-shaped toothing, double-action					
	21 mm	8393.185	•	•	83931857
fenestrated, with fine cross toothing, 15 mm long, single-action					
	26 mm	8393.184	•	•	83931847
fenestrated, with fine cross toothing, 20 mm long, single-action		8394.184		•	83941847

* JL = jaw length when jaw section closed (approximate measurements)
HF connection cable: see page THORAX105/106

V124 | Subject to modifications. Please note that some products may not be available in all countries. Please always take note of the information that is provided with the product. For more detailed information, please consult with your contact partner or directly with Richard Wolf GmbH.

ERAGON modular





Ø 5.0 MM, INSULATED







Jaw insert			Sheath tube, Ø 5.0 mm, insulated			Handle, pistol-shaped			Complete instrument • Jaw insert with sheath tube • Handle
									
			SL 260 mm	SL 330 mm	SL 450 mm	with lock, without HF	without lock, with HF, mono	with lock, with HF, mono	Product no.
	JL*	Product no.	8392933	8393933	8394933	83930072	83930073	83930074	
 Dolphin dissector forceps mono Ø 5 mm bndl angled, with fine cross-toothing, with channel, narrow, 15 mm long, double-action	17 mm	8393.285		•			•		83932857
 Dissector forceps mono Ø 5 mm bndl fine pyramid-shaped toothing, narrow, 18 mm, double-action	23 mm	8393.289		•				•	83932897
 Atraumat. grasping forceps Ø 5 mm bndl Channel with wavy tooth edge, 20 mm, single-action	26 mm	8393.292		•		•			83932925
 Atraumat. grasping forceps Ø 5 mm bndl Channel with wavy tooth edge, 20 mm, double-action	26 mm	8393.293		•		•			83932935
		8394.293			•	•			83942935
 Grasping forceps, mono Ø 5 mm bndl fine, pyramid-shaped toothing, narrow double-action	19 mm	8393.288		•				•	83932887
 Atraumat. grasping forceps mono Ø 5 mm bndl fenestrated, with cross toothing, double-action	19 mm	8392.181	•					•	83921817
		8393.181		•				•	83931817
		8394.181			•			•	83941817

* JL = jaw length when jaw section closed (approximate measurements)

HF connection cable: see page THORAX105/106

ERAGON^{modular}
 Ø 5.0 MM, INSULATED









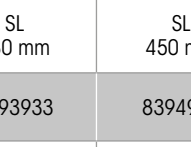

		Handle, axial			
ERAGON^{axial}					
All jaw inserts and sheath tubes can also be combined with ERAGON ^{axial} .		with lock	without lock, with HF connector	without lock, with HF connector	with lock, not rotatable
Rotatable knob	Product no.	83930082	83930083	83930084	83930085
	8988	•	•	•	

Jaw insert		Sheath tube, Ø 5.0 mm, insulated		Handle, pistol-shaped		Complete instrument	
						<ul style="list-style-type: none"> • Jaw insert with sheath tube • Handle 	
		SL 330 mm	SL 450 mm	with lock, without HF	without lock, with HF, mono		
	JL*	Product no.	8393933	8394933	83930072	83930073	Product no.
	18 mm	8393.195	•			•	83931957
smooth, double-action		8394.195		•		•	83941957
	24 mm	8393.186	•			•	83931867
Gripping surface with fine cross tothing, double-action							
	26 mm	8393.187	•			•	83931877
large distal gripping surface with fine cross tothing, double-action			8394.187		•		•
	39 mm	8393190	•			•	83931907
atraumatic clamp, double-action							

* JL = jaw length when jaw section closed (approximate measurements)
 HF connection cable: see page THORAX105/106

ERAGON modular

Ø 5.0 MM, INSULATED





Jaw insert			Sheath tube, Ø 5.0 mm, insulated		Handle, pistol-shaped		Complete instrument • Jaw insert with sheath tube • Handle
							
			SL 330 mm	SL 450 mm	with lock, without HF	with lock, with HF, mono	
	JL*	Product no.	8393933	8394933	83930072	83930074	Product no.
 Debaquey forceps Ø 5 mm bndl atraumatic clamp, double-action	48 mm	8393191	•		•		83931917
 Grasping forceps, mono Ø 5 mm bndl with row of teeth, double-action	17 mm	8393.485	•			•	83934857
 Grasping forceps, mono Ø 5 mm bndl with one tooth, fine cross tooth- ing, narrow, double-action	19 mm	8393.486	•			•	83934867
 Grasping forceps, mono Ø 5 mm bndl with two teeth, fine cross toothing, single-action	17 mm	8393.487	•			•	83934877
 Grasping forceps Ø 5 mm bndl with two teeth wavy gripping surface, dou- ble-action	26 mm	8393.490	•		•		83934907
		8394.490		•	•		83944907
 Petelin dissector forceps mono Ø 5 mm bndl angled 30° to the left, with cross toothing, single-action	17 mm	8393.282	•			•	83932827









* JL = jaw length when jaw section closed (approximate measurements)

HF connection cable: see page THORAX105/106

V124 || Subject to modifications. Please note that some products may not be available in all countries. Please always take note of the information that is provided with the product. For more detailed information, please consult with your contact partner or directly with Richard Wolf GmbH.

ERAGON^{modular}
 Ø 5.0 MM, INSULATED







		Handle, axial			
ERAGON^{axial}					
All jaw inserts and sheath tubes can also be combined with ERAGON ^{axial} .		with lock	without lock, with HF connector	without lock, with HF connector	with lock, not rotatable
Rotatable knob	Product no.	83930082	83930083	83930084	83930085
	8988	•	•	•	

Jaw insert		Sheath tube, Ø 5.0 mm, insulated		Handle, pistol-shaped			Complete instrument
							<ul style="list-style-type: none"> • Jaw insert with sheath tube • Handle
	JL*	Product no.	8393933	83930072	83930073	83930074	Product no.
 Plate-shaped grasping forceps mono Ø 5 mm bndl fenestrated with fine cross tooting, double-action	18 mm	8393.182	•			•	83931827
 Grasping forceps mono Ø 5 mm bndl with cross tooting, double-action	21 mm	8393.183	•		•		83931837
 Grasping forceps mono Ø 5 mm bndl distal cross tooting with channel, double-action	15 mm	8393.287	•		•		83932877
 Claw grasping forceps Ø 5 mm bndl double-action	27 mm	8393.494	•	•			83934945

* JL = jaw length when jaw section closed (approximate measurements)
 HF connection cable: see page THORAX105/106

ERAGON modular

Ø 5.0 MM, INSULATED







Jaw insert			Sheath tube, Ø 5.0 mm, insulated		Handle, pistol-shaped			Complete instrument • Jaw insert with sheath tube • Handle
			SL 330 mm	SL 450 mm	with lock, without HF	without lock, with HF, mono	with lock, with HF, mono	
	JL*	Product no.	8393933	8394933	83930072	83930073	83930074	Product no.
 Myoma grasping forceps Ø 5 mm bndl	29 mm	8393.488	•		•			83934887
2x3-claw, single-action								
 Universal grasping forceps mono Ø 5 mm bndl	18 mm	8393.481	•				•	83934817
with pyramid-shaped toothings and cross toothings, double-action								
 Universal grasping forceps Ø 5 mm bndl	26 mm	8393.482	•		•			83934827
pyramid-shaped toothings and cross toothings, double-action								
 Grasping forceps mono Ø 5 mm bndl	20 mm	8393.483	•				•	83934837
Pike-mouth, double-action								
 Biopsy forceps mono Ø 5 mm bndl	13 mm	8393.091	•			•		83930917
with spikes, double-action		8394.091		•		•		83940917
 Biopsy forceps mono Ø 5 mm bndl	14 mm	8393.092	•			•		83930927
severing, single-action		8394.092		•		•		83940927







* JL = jaw length when jaw section closed (approximate measurements)

HF connection cable: see page THORAX105/106

ERAGON modular

Ø 5.0 MM, INSULATED

		Handle, axial			
					
All jaw inserts and sheath tubes can also be combined with ERAGONaxial.		with lock	without lock, with HF connector	without lock, with HF connector	with lock, not rotatable
Rotatable knob	Product no.	83930082	83930083	83930084	83930085
	8988	•	•	•	

Jaw insert		Sheath tube, Ø 5.0 mm, insulated		Handle, pistol-shaped		Complete instrument • Jaw insert with sheath tube • Handle	
							
	JL*	Product no.	SL 330 mm	SL 450 mm	with lock, without HF	without lock, with HF, mono	Product no.
 Biopsy forceps mono Ø 5 mm bndl pointed spoon forceps, single-action	20 mm	8393.093	•			•	83930937
 Knot pusher Ø 5 mm bndl with distal recess, double-action	17 mm	8393.345	•		•		83933457
		8394.345		•	•		83943457
 Grasping forceps Ø 5 mm bndl spring jaw sections fenestrated with cross toothings, double-action	37 mm	8393.188	•		•		83931887
 Grasping forceps Ø 5 mm bndl spring jaw sections fenestrated with cross toothings, double-action	47 mm	8393.189	•		•		83931897
		8394.189		•	•		83941897







* JL = jaw length when jaw section closed (approximate measurements)

HF connection cable: see page THORAX105/106

V124 || Subject to modifications. Please note that some products may not be available in all countries. Please always take note of the information that is provided with the product. For more detailed information, please consult with your contact partner or directly with Richard Wolf GmbH.

ERAGON modular





Ø 5.0 MM, INSULATED







Jaw insert			Sheath tube, Ø 5.0 mm, insulated		Handle, pistol-shaped		Complete instrument • Jaw insert with sheath tube • Handle
			SL 330 mm	SL 450 mm	with lock, without HF	with lock, with HF, mono	
	JL*	Product no.	8393933	8394933	83930072	83930074	Product no.
 Debaquey forceps Ø 5 mm bndl atraumatic, spring jaws with cross toothing, double-action	47 mm	8393.291	•		•		83932917
 Dissector forceps mono Ø 5 mm bndl angled, double-action	18 mm	8393192	•			•	83931927
		8394192		•		•	83941927
 Grasping forceps, mono Ø 5 mm bndl double-action	16 mm	8393193	•		•		83931937
		8394193		•	•		83941937
 Dissector forceps mono Ø 5 mm bndl double-action	24 mm	8393194	•			•	83931947
		8394194		•		•	83941947
 Dissector forceps mono Ø 5 mm bndl double-action	30 mm	8393197	•			•	83931977
		8394197		•		•	83941977
 Dissector forceps mono Ø 5 mm bndl fine tips double-action	33 mm	8393198	•			•	83931987
		8394198		•		•	83941987

* JL = jaw length when jaw section closed (approximate measurements)

HF connection cable: see page THORAX105/106

ERAGON^{modular}
 Ø 5.0 MM, INSULATED







		Handle, axial			
ERAGON^{axial}					
All jaw inserts and sheath tubes can also be combined with ERAGON ^{axial} .		with lock	without lock, with HF connector	without lock, with HF connector	with lock, not rotatable
Rotatable knob	Product no.	83930082	83930083	83930084	83930085
	8988	•	•	•	

Jaw insert		Sheath tube, Ø 5.0 mm, insulated		Handle, pistol-shaped	Complete instrument	
					<ul style="list-style-type: none"> • Jaw insert with sheath tube • Handle 	
		SL 330 mm	SL 450 mm	with lock, with HF, mono		
	JL*	Product no.	8393933	8394933	83930074	Product no.
	32 mm	8393199	•	•	•	83931997
double-action		8394199		•	•	83941997
	19 mm	8393200	•	•	•	83932007
fine tip, double-action		8394200		•	•	83942007
	16 mm	8393210	•	•	•	83932107
atraumatic, with cross toothing, double-action						
	19 mm	8393220	•	•	•	83932207
atraumatic, with cross toothing, double-action		8394220		•	•	83942207

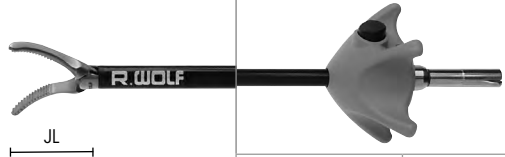
* JL = jaw length when jaw section closed (approximate measurements)
 HF connection cable: see page THORAX105/106

ERAGON modular





Ø 5.0 MM, INSULATED



Jaw insert			Sheath tube, Ø 5.0 mm, insulated		Handle, pistol-shaped		Complete instrument • Jaw insert with sheath tube • Handle
			SL 330 mm	SL 450 mm	with lock, without HF	with lock, with HF, mono	
							Product no.
 Atraum. grasping forceps Ø 5 mm bndl atraumatic, with pyramid-shaped tothing and cross tothing, double-action	29 mm	8393223	•	•	•	•	83932237
		8394223		•	•		83942237
 Atraum. grasping forceps Ø 5 mm bndl atraumatic, single fenestrated with cross tothing, double-action	25 mm	8393250	•	•	•	•	83932507
		8394250		•	•		83942507
 Atraum. grasping forceps Ø 5 mm bndl atraumatic, double fenestrated and curved single-action	32 mm	8393229	•	•	•	•	83932297
		8394229		•	•		83942297
 Grasping forceps Ø 5 mm bndl atraumatic, narrow and rounded, double-action	15 mm	8393230	•	•	•	•	83932307
		8394230		•	•		83942307
 Dissector forceps mono Ø 5 mm bndl curved, double-action	19 mm	8393240	•	•	•	•	83932407
		8394240		•	•		83942407
 Dissector forceps mono Ø 5 mm bndl single fenestrated double-action	17 mm	8393242	•	•	•	•	83932427
		8394242		•	•		83942427

* JL = jaw length when jaw section closed (approximate measurements)
 HF connection cable: see page THORAX105/106

V124 || Subject to modifications. Please note that some products may not be available in all countries. Please always take note of the information that is provided with the product. For more detailed information, please consult with your contact partner or directly with Richard Wolf GmbH.

ERAGON^{modular}
 Ø 5.0 MM, INSULATED

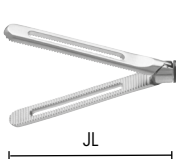







		Handle, axial			
ERAGON^{axial}					
All jaw inserts and sheath tubes can also be combined with ERAGON^{axial} .		with lock	without lock, with HF connector	without lock, with HF connector	with lock, not rotatable
Rotatable knob	Product no.	83930082	83930083	83930084	83930085
	8988	•	•	•	

Jaw insert		Sheath tube, Ø 5.0 mm, insulated		Handle, pistol-shaped		Complete instrument
						<ul style="list-style-type: none"> • Jaw insert with sheath tube • Handle
	JL*	SL 330 mm	SL 450 mm	with lock, without HF	with lock, with HF, mono	Product no.
Intestine grasping forceps Ø 5 mm bndl	38 mm	8393249		•		83932497
atraumatic, single fenestrated with cross toothing, double-action		8394249		•		83942497
Debaquey forceps mono Ø 5 mm bndl	35 mm	8393256		•	•	83932567
curved, double-action						
Debaquey forceps mono Ø 5 mm bndl	47 mm	8393258		•		83932587
double-action		8394258		•		83942587

* JL = jaw length when jaw section closed (approximate measurements)
 HF connection cable: see page THORAX105/106

ERAGON modular





Ø 5.0 MM, INSULATED



Jaw insert			Sheath tube, Ø 5.0 mm, insulated		Handle, pistol-shaped	Complete instrument • Jaw insert with sheath tube • Handle
			SL 330 mm	SL 450 mm	 without lock, with HF, mono	
			Product no.	8393933		8394933
 Metzenbaum scissors mono Ø 5 mm bndl 23 mm curved, double-action	JL*	8393.041	•		•	83930417
		8394.041		•	•	83940417
 Metzenbaum micro scissors mono Ø 5 mm bndl 18 mm curved, double-action	JL*	8393.044	•		•	83930447
 Scissors mono Ø 5 mm bndl 20 mm narrow, straight, double-action	JL*	8393.045	•		•	83930457
 Hook scissors mono Ø 5 mm bndl 14 mm serrated, single-action	JL*	8393.081	•		•	83930817
		8394.081		•	•	83940817
 Metzenbaum micro scissors mono Ø 5 mm bndl 21 mm double-action	JL*	8393243	•		•	83932437
		8394243		•	•	83942437
 Scissors mono Ø 5 mm bndl 26 mm curved and toothed double-action	JL*	8393246	•		•	83932467
		8394246		•	•	83942467

* JL = jaw length when jaw section closed (approximate measurements)

HF connection cable: see page THORAX105/106

ERAGON^{modular}
 Ø 5.0 MM, INSULATED

		Handle, axial			
ERAGON^{axial}					
All jaw inserts and sheath tubes can also be combined with ERAGON ^{axial} .		with lock	without lock, with HF connector	without lock, with HF connector	with lock, not rotatable
Rotatable knob	Product no.	83930082	83930083	83930084	83930085
	8988	•	•	•	

Jaw insert		Sheath tube, Ø 5.0 mm, insulated		Handle, pistol-shaped		Complete instrument
						<ul style="list-style-type: none"> • Jaw insert with sheath tube • Handle
	JL*	SL 330 mm	SL 450 mm	with lock, without HF	without lock, with HF, mono	
	Product no.	8393933	8394933	83930072	83930073	Product no.
Scissors mono Ø 5 mm bndl	22 mm	8393248	•		•	83932487
fine-toothed, fine tip double-action		8394248	•		•	83942487
Knot pusher Ø 5 mm bndl	17 mm	8393.345	•	•		83933457
with distal recess, double-action		8394345	•	•		83943457
Gastric band manipulator Ø 5 mm bndl	47 mm	8393253	•	•		83932537
90° articulating with distal slot		8394253	•	•		83942537



* JL = jaw length when jaw section closed (approximate measurements)

HF connection cable: see page THORAX105/106

Accessories for manual and machine reprocessing	Product no.
	Irrigation adapter Ø 9 mm, length 64 mm 163502

V124 || Subject to modifications. Please note that some products may not be available in all countries. Please always take note of the information that is provided with the product. For more detailed information, please consult with your contact partner or directly with Richard Wolf GmbH.

ERAGON^{modu} blades
 Ø 5.0 MM, INSULATED

 All jaw inserts and sheath tubes can also be combined with ERAGONaxial .		Handle, axial	
		 without lock, with HF connector	
Rotatable knob	Product no.	83930083	
	8988	•	

Scissors attachment		Tension rod Ø 5.0 mm			Sheath tube insulated Ø 5.0 mm			Handle pistol-shaped	Complete instrument • Jaw insert with sheath tube • Handle	
										
		for SL 260 mm	for SL 330 mm	for SL 450 mm	SL 240 mm	SL 310 mm	SL 430 mm	without lock, rotatable with HF connector		
	Product no.	8392934	8393934	8394934	8392935	8393935	8394935	83930073	Product no.	
Metzenbaum scissors attachment mono	 4393.040 (PU = 10 PCS), sterile, for single use	•			•			•	83920407	
		•				•			•	83930407
		•							•	83940407







ERAGONMODULAR







3.4

HF connection cable: see page THORAX105/106

V124 || Subject to modifications. Please note that some products may not be available in all countries. Please always take note of the information that is provided with the product. For more detailed information, please consult with your contact partner or directly with Richard Wolf GmbH.

ERAGON modular
Ø 10 MM, UNINSULATED

		Handle, axial	
 All jaw inserts and sheath tubes can also be combined with ERAGONaxial.			
		with lock, without HF connector	with lock, without HF connector, not rotatable
Rotatable knob	Product no.	83930082	83930085
	8988	.	.

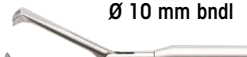





Jaw insert		Sheath tube, Ø 10.0 mm, uninsulated		Handle, pistol-shaped	Complete instrument
					<ul style="list-style-type: none"> • Jaw insert with sheath tube • Handle
		SL 327 mm	SL 447 mm	with lock, without HF	
	JL*	Product no.	8395902	8396902	Product no.
	36 mm	8395.225	.	.	83952257
double-action		8396225	.	.	83962257
	35 mm	8395.226	.	.	83952268
angled, double-action		8396226	.	.	83962267
	20 mm	8395.236	.	.	83952368
Pike-mouth double-action		8396236	.	.	83962367
	49 mm	8395.204	.	.	83952048
2/3 clawed single-action		8396204	.	.	83952047

* JL = jaw length when jaw section closed (approximate measurements)
 HF connection cable: see page THORAX105/106

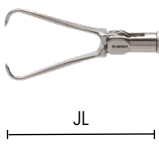
V124 || Subject to modifications. Please note that some products may not be available in all countries. Please always take note of the information that is provided with the product. For more detailed information, please consult with your contact partner or directly with Richard Wolf GmbH.

ERAGON modular

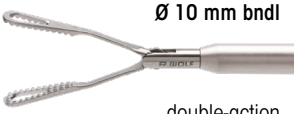
Ø 10 MM, UNINSULATED

Jaw insert			Sheath tube, Ø 10.0 mm, uninsulated			Handle, pistol-shaped		Complete instrument • Jaw insert with sheath tube • Handle
			SL 327 mm	SL 447 mm	SL 387 mm	with lock, without HF		
	JL*	Product no.	8395902	8396902	8397902	83930072	83930082	Product no.
 Claw grasping forceps Ø 10 mm bndl double-action	38 mm	8395.489	•			•		83954897
 Claw grasping forceps Ø 10 mm bndl with additional row of teeth, double-action	38 mm	8395490	•			•		83954907
 Babcock forceps Ø 10 mm bndl large distal gripping surface with fine cross toothing, double-action	42 mm	8395.187	•			•		83951877
		8396187		•		•		83961877
 Babcock forceps Ø 10 mm bndl double-action	38 mm	8395.214	•			•		83952148
 Plate-shaped grasping forceps Ø 10 mm bndl double-action	50 mm	8395.234	•			•		83952347
		8396234		•		•		83962347
 Spoon forceps Ø 10 mm bndl single-action	31 mm	8395.244	•			•		83952448
 Stapler head grasping forceps Ø 10 mm bndl angled 30°, double-action		8397.655			•		•	83976558





* JL = jaw length when jaw section closed (approximate measurements)/HF connection cable: see page THORAX105/106

ERAGON^{stitch}
NEEDLE HOLDER Ø 3.5 MM

ERAGONMODULAR

3.4









Needle holder jaw insert			Sheath tube, Ø 3.5 mm		Needle holder handle		Complete instrument • Jaw insert • Sheath tube • Handle
							
							SL 240 mm
	JL*	Product no.	8390533	8391533	8393943	8393944	Product no.
	12 mm	8391505	•		•		83915053
			•		•		83915054
straight with carbide insert single-action		8391506		•	•		83915063
				•		•	83915064

* JL = jaw length when jaw section closed (approximate measurements)

Accessories for manual and machine reprocessing	Product no.
 Irrigation adapter cleaning Ø 9 mm, length 64 mm for uninsulated sheath tubes	163503

ERAGON^{stitch}

NEEDLE HOLDER Ø 5.0 MM

Needle holder jaw insert			Sheath tube, Ø 5.0 mm		Needle holder handle		Complete instrument • Jaw insert • Sheath tube • Handle
							
	JL*	Product no.	8393533	8394533	8393943	8393944	Product no.
	19 mm	Needle holder Ø 5 mm bndl	•		•		83935073
			•			•	83935074
straight with carbide insert single-action	19 mm	8393507		•	•		83945073
		8394507		•		•	83945074
	19 mm	Needle holder Ø 5 mm bndl	•		•		83935083
			•			•	83935084
straight and narrow with carbide insert single-action	19 mm	8393508		•	•		83945083
		8394508		•		•	83945084
	19 mm	Needle holder jaw insert Ø 5 mm bndl	•		•		83935093
			•			•	83935094
straight, with self-righting function single-action	19 mm	8393509		•	•		83945093
		8394509		•		•	83945094





* JL = jaw length when jaw section closed (approximate measurements)

Accessories for manual and machine reprocessing		Product no.
	Irrigation adapter cleaning Ø 9 mm, length 64 mm for uninsulated sheath tubes	163503

ERAGON *stitch*
NEEDLE HOLDER Ø 5.0 MM

ERAGONMODULAR

3.4

Needle holder jaw insert			Sheath tube, Ø 5.0 mm		Needle holder handle		Complete instrument • Jaw insert • Sheath tube • Handle	
								
								SL 330 mm
	JL*	Product no.	8393533	8394533	Axial	Angled	Product no.	
 Needle holder Ø 5 mm bndl	19 mm	8393518	•		•		83935183	
			•			•	83935184	
		8394518		•		•		83945183
				•			•	83945184
 Needle holder Ø 5 mm bndl	19 mm	8393519	•		•		83935193	
			•			•	83935194	
		8394519		•		•		83945193
				•			•	83945194



Accessories for manual and machine reprocessing		Product no.
	Irrigation adapter cleaning Ø 9 mm, length 64 mm for uninsulated sheath tubes	163503

V124 || Subject to modifications. Please note that some products may not be available in all countries. Please always take note of the information that is provided with the product. For more detailed information, please consult with your contact partner or directly with Richard Wolf GmbH.

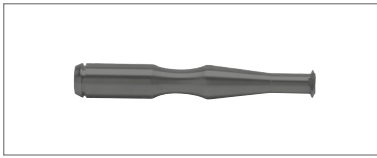
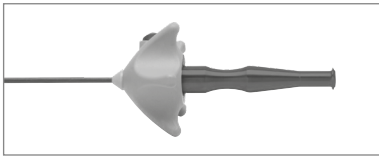
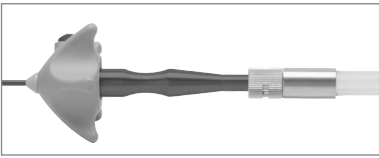
ERAGON^{modular}
ACCESSORIES

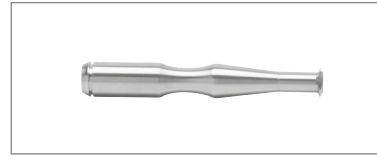
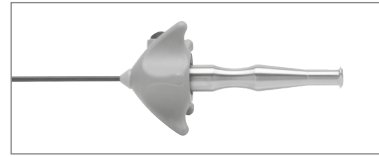
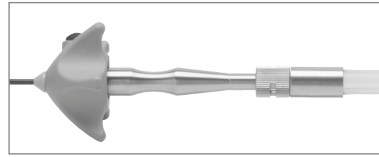
For insulated sheath tubes		Product no.
	For manual and machine reprocessing: Irrigation adapter Ø 9 mm, length 64 mm for insulated sheath tubes	163502
		











For uninsulated sheath tubes		Product no.
	For manual and machine reprocessing: Irrigation adapter cleaning Ø 9 mm, length 64 mm for uninsulated sheath tubes	163503
		



	8393932
	8394932

		Ø	SL	Product no.
	Sheath tube insulated Ø 5 mm SL 330 mm with distal cm scale	5 mm	330 mm	8393932
	Sheath tube insulated Ø 5 mm SL 450 mm with distal cm scale	5 mm	450 mm	8394932

VI24 || Subject to modifications. Please note that some products may not be available in all countries. Please always take note of the information that is provided with the product. For more detailed information, please consult with your contact partner or directly with Richard Wolf GmbH.

HANDLE VARIANTS FOR MODULAR SYSTEMS



Handle, pistol-shaped 		rotatable	with lock	without lock	with HF	without HF	Product no.
		•	•			•	83930072
		•		•	•		83930073
		•	•		•		83930074
Handle, axial 		rotatable	with lock	without lock	with HF	without HF	Product no.
		•	•			•	83930082
		•		•	•		83930083
		•	•		•		83930084
			•			•	83930085
Optional for 83930082/83930083/83930084:							Product no.
		Rotatable knob autoclavable				8988	

All  components are compatible with 

V124 || Subject to modifications. Please note that some products may not be available in all countries. Please always take note of the information that is provided with the product. For more detailed information, please consult with your contact partner or directly with Richard Wolf GmbH.

NEEDLE HOLDER HANDLE

Needle holder handle, axial	not rotatable	with lock	without HF	Product no.
	•	•	•	8393.941



Needle holder handle <small>ERAGON^{stitch}</small>	axial	angled	with on-off detent mechanism	single-action	not rotatable	Product no.
	•		•	•	•	8393943
		•		•	•	8393944

SCISSORS / TISSUE RETRACTORS

SCISSORS / TISSUE RETRACTORS

3.5



with irrigation connector		Ø	WL	TL	Product no.
	Scissors Ø 6.5 mm WL 260 mm Jaw section straight, sheath straight, single opening	6.5 mm	260 mm	392 mm	8243.403
	Scissors curved Ø 7 mm WL 260 mm Jaw section curved, sheath straight, single opening	7.0 mm	260 mm	392 mm	8243.404



with irrigation connector		Ø	WL	TL	Product no.
	Tissue retractor Ø 6.5 mm WL 330 mm Jaw section curved downward, sheath straight	6.5 mm	330 mm	492 mm	8243.701

V124 || Subject to modifications. Please note that some products may not be available in all countries. Please always take note of the information that is provided with the product. For more detailed information, please consult with your contact partner or directly with Richard Wolf GmbH.

MULTIFUNCTIONAL SUCTION IRRIGATION SYSTEM

COMBINATION OPTIONS

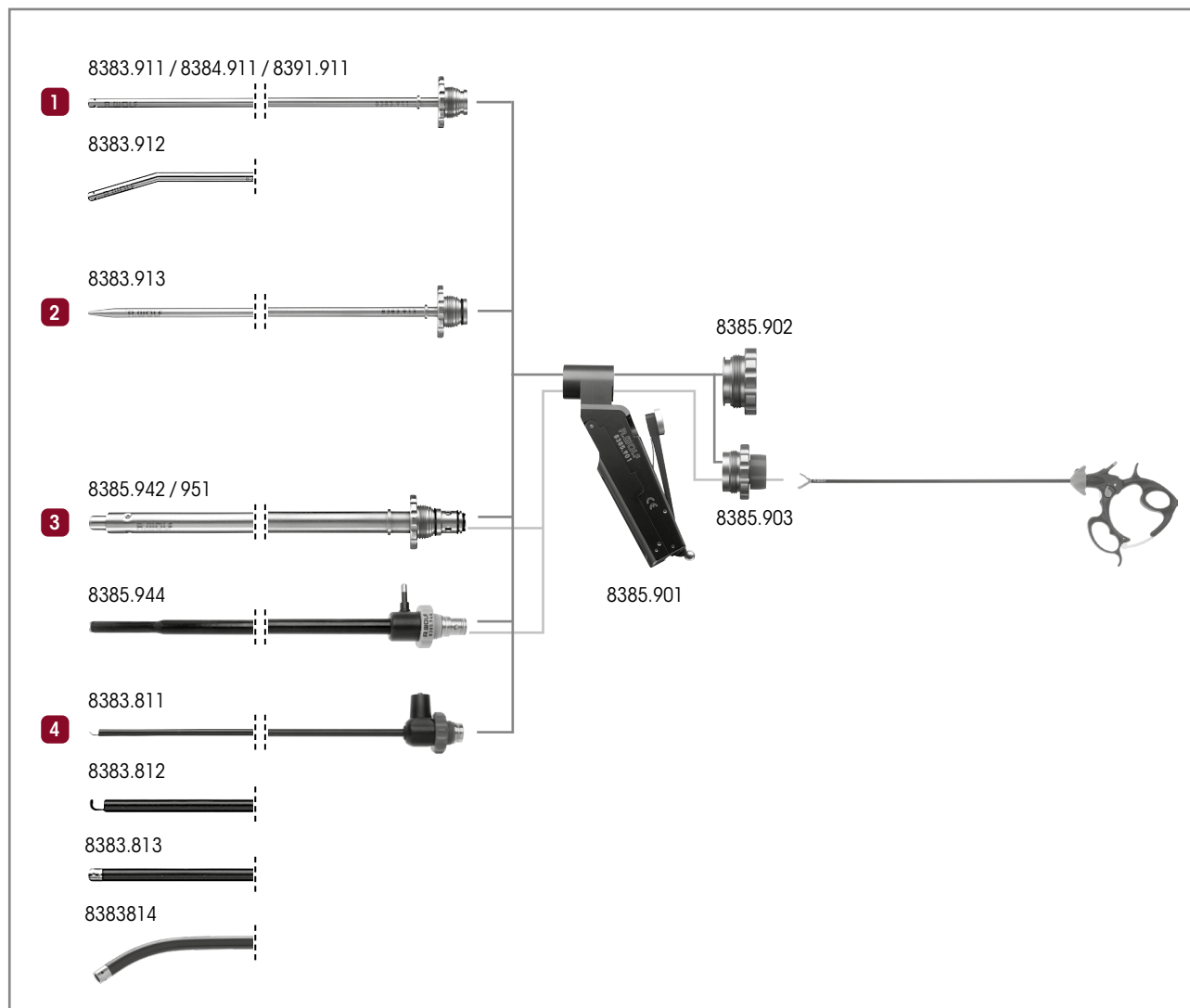

1 Suction or irrigation:

Suction irrigation tube Ø 5 mm WL 310 mm	8383.911
Suction irrigation tube Ø 5 mm WL 450 mm	8384.911
Suction irrigation tube Ø 3.5 mm WL 300 mm	8391.911
Suction irrigation tube curved Ø 5 mm WL 310 mm...	8383.912
for this: Sealing cap	8385.902

2 Blunt aquadissection:

Pressure irrigation tube Ø 5 mm WL 310 mm	8383.913
for this: Sealing cap	8385.902

3 Suction, irrigation, and use

of auxiliary instruments Ø 5 mm:

Suction irrigation tube Ø 10 mm WL 225 mm	8385.942
Suction irrigation tube Ø 10 mm WL 330 mm	8385.951
Suction irrigation tube Ø mono 10 mm WL 330 mm, insulated, with atraumatic preparation tip	8385.944
for this: Sealing adapter	8385.903

4 Preparation of tissue with HF:

HF suction irrigation tube Ø 5.2 mm WL 317 mm insulated with integrated HF spatula probe	8383.811
HF suction irrigation tube Ø 5.2 mm WL 317 mm insulated with integrated HF hook electrode	8383.812
HF suction irrigation tube Ø 5.2 mm WL 317 mm insulated with integrated HF button electrode	8383.813
HF suction irrigation tube Ø 5.4 mm WL 380 mm curved with distal openings, insulated with integrated HF button electrode	8383.814
for this: Sealing cap	8385.902

MULTIFUNCTIONAL SUCTION IRRIGATION SYSTEM
SUCTION IRRIGATION HANDLE

MULTIFUNCTIONAL SUCTION AND IRRIGATION SYSTEM
3.6

 <p>8385.901</p> <p>AUTOCLAVE 134° C / 273° F</p>	
Product no.	
<p>Suction irrigation handle</p>	8385.901
<p>Sealing cap</p>	8385.902
<p>Required to use auxiliary instruments Ø 5 mm: Sealing attachment with opening and membrane valve</p>	8385.903
<p>Spare Sealing membrane Ø 17 mm yellow, Ø 17 mm, PU = 10 PCS, for instruments from 3 to 6 mm</p>	89.103

V124 || Subject to modifications. Please note that some products may not be available in all countries. Please always take note of the information that is provided with the product. For more detailed information, please consult with your contact partner or directly with Richard Wolf GmbH.

MULTIFUNCTIONAL SUCTION IRRIGATION SYSTEM

SUCTION IRRIGATION TUBE SETS – ILLUSTRATION

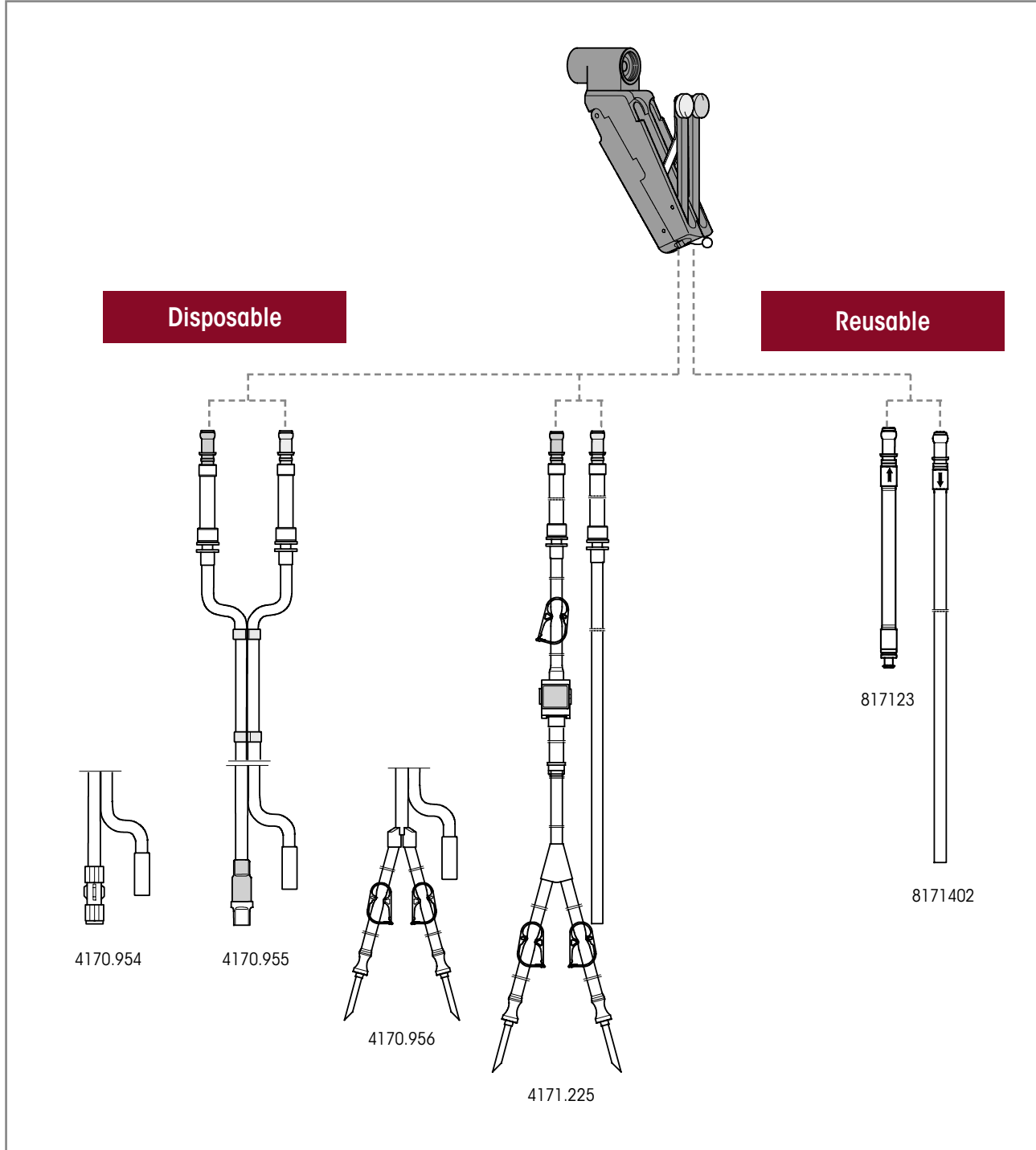

Suction irrigation tube sets are used in conjunction with the suction irrigation handle 8385.901 and pump-side tube systems as well as corresponding collection and secretion containers and/or vacuum pumps.

MULTIFUNCTIONAL SUCTION IRRIGATION SYSTEM



SUCTION IRRIGATION TUBE SETS FOR SUCTION IRRIGATION HANDLE 8385.901

Disposable		Product no.
Suction irrigation tube set, L 3 m (PACK= 10 PCS), sterile	Irrigation tube: With Luer-Lock, for connection to the irrigation tube of a suction irrigation tube set, e.g., irrigation tube of the Endo-Irrigator 2211 Suction tube: For connection to a collection or secretion container and/or vacuum pump	4170.954
Suction irrigation tube set with care-lock, L 3 m (PACK= 10 PCS), sterile	Irrigation tube: With CARE-LOCK, for connection to an irrigation container Suction tube: For connection to a collection or secretion container and/or vacuum pump	4170.955
Suction irrigation tube set with piercing spike, L 3 m (PACK= 10 PCS), sterile	Irrigation tube: With 2 piercing spikes, for connection to an irrigation container Suction tube: For connection to a collection or secretion container and/or vacuum pump	4170.956
Suction irrigation tube set, L 3 m (PACK= 10 PCS), sterile	Irrigation tube: With 2 piercing spikes, for connection to an irrigation container, and Fluid Control Lap 2216 Suction tube: For connection to a collection or secretion container and/or vacuum pump Also observe instruction manual GA-A 276	4171.225
Secretion container, 2.5 l	2.5 liters	41706566
Tube set for suction (2 connections)	sterile disposable product (PACK= 10 PCS), for connecting instruments to collecting container	T0503-01



Reusable		Product no.
Irrigation tube L 1.2 m	Irrigation tube: With Luer-Lockconnection for connection to the irrigation tube of a suction irrigation tube set, e.g., 8171223 or 8170.223	817123
Suction tube L 3 m	silicone, for suction irrigation handle 8385.901	8171402
Secretion container, 2 l	2 liters, without cover	8170.6551
Cover	for secretion trap 8170.6551, reusable	8170.6552

MULTIFUNCTIONAL SUCTION IRRIGATION SYSTEM

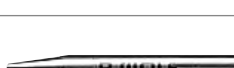
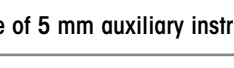
SUCTION IRRIGATION TUBES

		Outer Ø	WL	Product no.
	Suction irrigation tube Ø 3.5 mm WL 300 mm	3,5 mm	300 mm	8391.911
	Suction irrigation tube Ø 5 mm WL 310 mm	5,0 mm	310 mm	8383.911
	Suction irrigation tube Ø 5 mm WL 450 mm	5,0 mm	450 mm	8384.911
	Suction irrigation tube curved Ø 5 mm WL 310 mm	5,0 mm	310 mm	8383.912
	Pressure irrigation tube Ø 5 mm WL 310 mm	5,0 mm	310 mm	8383.913

For use of 5 mm auxiliary instruments

		Outer Ø	WL	Product no.
	Suction irrigation tube Ø 10 mm WL 225 mm	10,0 mm	225 mm	8385.942
 Capacity 5.0 mm	Suction irrigation tube Ø 10 mm WL 330 mm	10,0 mm	330 mm	8385.951

		Outer Ø	WL	Product no.
 Insulated, with atraumatic preparation tip	Suction irrigation tube mono Ø 10 mm WL 330 mm	10,0 mm	330 mm	8385.944

required for 8385.951:		Product no.	
	Sealing attachment	with opening and membrane valve Sealing membrane Ø 17 mm	8385.903





MULTIFUNCTIONAL SUCTION IRRIGATION SYSTEM

SUCTION IRRIGATION TUBES

MULTIFUNCTIONAL SUCTION AND IRRIGATION SYSTEM

3.6





		Outer Ø	WL	Product no.
 Insulated with integrated HF spatula probe	HF suction irrigation tube Ø 5.2 mm WL 317 mm	5.2 mm	317 mm	8383.811
 Insulated with integrated HF hook probe	HF suction irrigation tube Ø 5.2 mm WL 317 mm	5.2 mm	317 mm	8383.812
 Insulated with integrated HF button electrode	HF suction irrigation tube Ø 5.2 mm WL 317mm	5.2 mm	317 mm	8383.813
As alternative to suction irrigation handle:				
	Suction irrigation adapter with maintenance-free two-way stopcock, for multi-functional suction and irrigation tube system			8583819

Accessories	Product no.
HF connection cable	See THORAX105/106

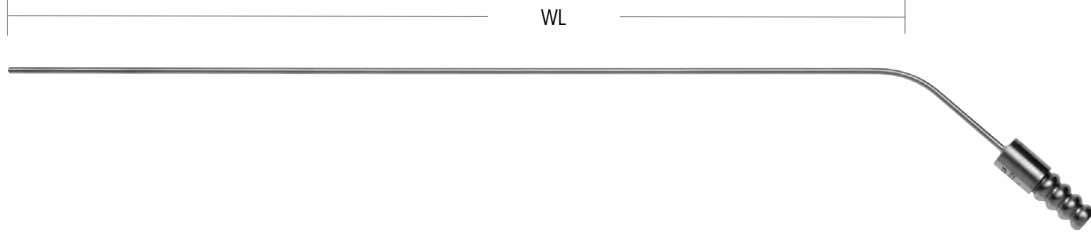
ACCESSORIES FOR SUCTION AND IRRIGATION



		Outer Ø	WL	Product no.
 central, lateral openings, rigid	Suction tube OD 2 mm WL 250 mm	2.0 mm	250 mm	8291.22
	Suction tube OD 2.5 mm WL 250 mm	2.5 mm	250 mm	8291.23
	Suction tube OD 3 mm WL 250 mm	3.0 mm	250 mm	8291.24
	Suction tube OD 4 mm WL 500 mm	4.0 mm	500 mm	8291.45



		Outer Ø	WL	Product no.
 graduated, with 3 mm Luer connecto	Suction tube OD 2.8 mm WL 450 mm	2.8 mm	450 mm	8380.68
	Suction tube graduated Ø 5 mm WL 330 mm	5.0 mm	330 mm	8383.68
	Suction tube OD 4.7 mm WL 450 mm	4,7 mm	450 mm	8384.68

ACCESSORIES
FOR SUCTION AND IRRIGATION

ACCESSORIES FOR SUCTION AND IRRIGATION

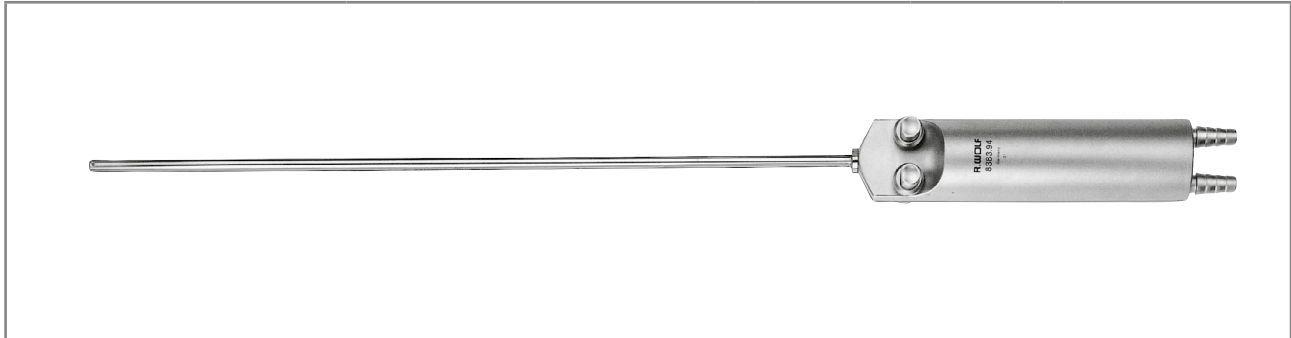

		Outer Ø	WL	Product no.
	Suction irrigation tube Ø 5 mm WL 300 mm	5,0 mm	300 mm	8383.94
with stop valve				

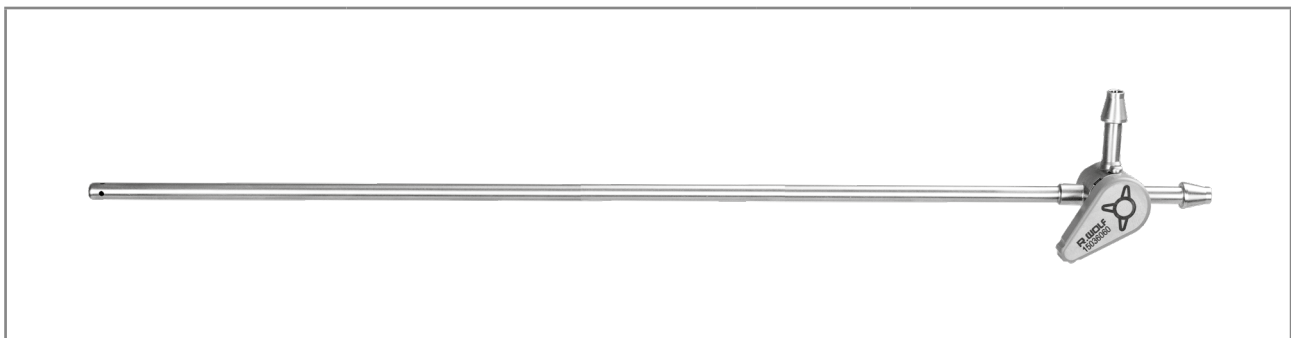

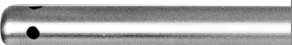
		Outer Ø	WL	Product no.
	Suction irrigation tube WL 290 mm	5.0 mm	290 mm	8583732
with maintenance-free two-way stopcock, sheath tube, with distal openings, reusable	Suction irrigation tube WL 410 mm	5.0 mm	410 mm	8584732

V124 || Subject to modifications. Please note that some products may not be available in all countries. Please always take note of the information that is provided with the product. For more detailed information, please consult with your contact partner or directly with Richard Wolf GmbH.

HAND BLOWER FOR SINGLE USE FOR SUCTION AND IRRIGATION

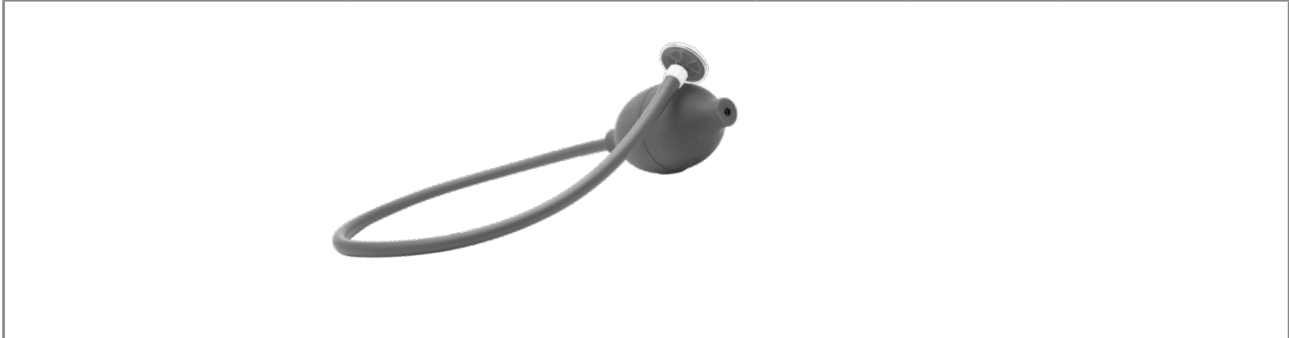

for air insufflation		Outer Ø	TL	Product no.
	<p>Hand blower with disposable filter, sterile (PU = 5 PCS)</p>	49 mm	567 mm	412700

ELECTRODES 5.0 MM

MONOPOLAR



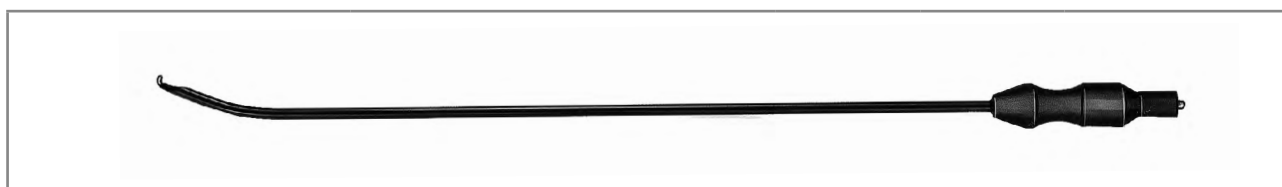

		Outer Ø	WL	Product no.
	Coagulation electrode mono Ø 5 mm WL 330 mm	5.0 mm	330 mm	8383.40
	Coagulation electrode mono Ø 5 mm WL 450 mm	5.0 mm	450 mm	8384.40





		Outer Ø	WL	Product no.
	Hook electrode mono Ø 5 mm WL 340 mm	5.0 mm	340 mm	8242.301





		Outer Ø	WL	Product no.
	Hook electrode mono Ø 5 mm WL 340 mm	5.0 mm	340 mm	8383.423
	Hook electrode mono Ø 5 mm WL 420 mm		420 mm	8384.423
	Needle electrode mono Ø 5 mm WL 340 mm	5.0 mm	340 mm	8383.426
	Spatula electrode mono Ø 5 mm WL 340 mm	5.0 mm	340 mm	8383.428

HF connection cable: see page THORAX105/106

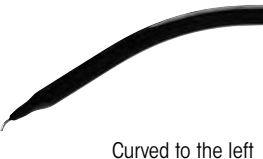

ELECTRODES 3.0 MM/4.9 MM



		Outer Ø	WL	Product no.
	Hook electrode mono Ø 3 mm WL 470 mm	3.0 mm	470 mm	84420.0003

		Outer Ø	WL	Product no.
 Curved to the left	Hook electrode mono Ø 4.9 mm WL 330 mm	4.9 mm	330 mm	84420.0004
 Curved to the right	Hook electrode mono Ø 4.9 mm WL 330 mm	4.9 mm	330 mm	84420.0006
 Curved	Hook electrode mono Ø 7 mm WL 335 mm		335 mm	84420.0005

|| Subject to modifications. Please note that some products may not be available in all countries. Please always take note of the information that is provided with the product. For more detailed information, please consult with your contact partner or directly with Richard Wolf GmbH.







NEEDLE HOLDER / KNOT PUSHER 5 MM





		Outer Ø	WL	Product no.
 <p>Curved</p>	Needle holder Ø 5.0 mm WL 300 mm	5.0 mm	300 mm	8242.451

		Outer Ø	WL	Product no.
	Hook probe TL 350 mm, SZ 5 mm	5.0 mm	350 mm	8243.461

ERAGON modular

MODULAR KNOT PUSHER Ø 5.0 MM, INSULATED

		Handle, axial			
					
All jaw inserts and sheath tubes can also be combined with ERAGONaxial .		with lock	without lock, with HF connector	without lock, with HF connector	with lock, not rotatable
Rotatable knob	Product no.	83930082	83930083	83930084	83930085
	8988	•	•	•	•



Jaw insert				Handle	Complete instrument • Jaw insert with sheath tube • Handle	
  JL		SL 330 mm	SL 450 mm	 with lock, without HF		
	JL*	Product no.	8393933	8394933	83930072	Product no.
Knot pusher Ø 5 mm bndl	17 mm	8393.345	•	•	•	83933457
 with distal recess, double-action		8394345	•	•	•	83943457

* JL = jaw length when jaw section closed (approximate measurements)

HF connection cable: see page Thorax109

V124 || Subject to modifications. Please note that some products may not be available in all countries. Please always take note of the information that is provided with the product. For more detailed information, please consult with your contact partner or directly with Richard Wolf GmbH.

CANNULA / SPONGE FORCEPS 3 MM

				
with Luer connector		Outer Ø	WL	Product no.
 Tip Ø 1.4 mm	Injection cannula Ø 3 mm WL 340 mm	3.0 mm	340 mm	8379.732

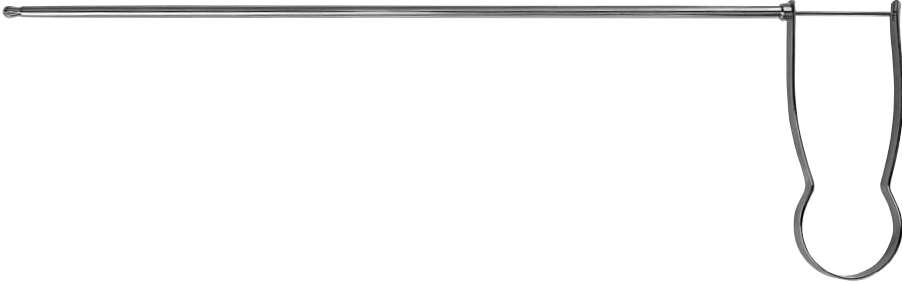
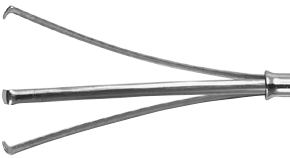
				
		Outer Ø	WL	Product no.
	Sponge forceps Ø 3.0 mm WL 300 mm	3.0 mm	300 mm	8148.02

V124 || Subject to modifications. Please note that some products may not be available in all countries. Please always take note of the information that is provided with the product. For more detailed information, please consult with your contact partner or directly with Richard Wolf GmbH.

bee-system II

Sternum saw



		Product no.
bee-system II Sternum saw	with keyless top for sternum (F-30-400-05)	F-31-601-00
Accessories: see page Thorax105		

- Precise incision with excellent visibility
- Easy clamping of the saw blade (no tools required)
- Use of saw blades with Stryker adapter
- Protection sleeve can be fastened in 4 different positions (locked in each position at 90°)
- Basic model can be used as jigsaw.

Technical data for F-31-601-00	
Handpiece dimensions (without top)	185 x 111 x 206 mm
Handpiece weight (with power pack)	1,750 g
Continuously adjustable speed	0–7,500 cycles/min (level I) / 0–10,000 cycles/min (level II)
Protection class	B, EN 60601-1
Power supply	Internal battery

bee-system II

Power pack

Universal drive unit for all bee-system handpieces



		Product no.
Power pack	Universal drive unit for all bee-system handpieces, latest Li-ion technology.	F-30-900-00
for this: Charging unit: see page Thorax105		

- 1 Power pack for all handpieces
- Contains control device, battery, electronic components, and motor all in one power pack
- Automatic detection of the power parameters depending on the handpiece used
- Unique shelf life, no need to sterilize sensitive components
- Latest battery technology – long service life, no memory effect
- Battery charge control indicator: green, orange, red (discharged)
- White LEDs for additional illumination of the surgical area

Technical data for F-30-900-00	
Dimensions	89 x 87 x 102 mm
Weight	760 g
Model	Li-ion
Max. voltage	16.8 V
Operating voltage (nominal voltage)	14.4 V
Capacity	2.1 Ah
Average charge time	< 90 min

bee-system II

Charging unit



	Product no.
Charging unit (1 charging slot)	F-30-900-50
Charging unit (2 charging slots)	F-30-900-51
Charging unit (4 charging slots)	F-30-900-52







- All charging units display the charge state of the power packs.
- In addition to the charge state, the charging unit displays the charge capacity for each power pack slot.

Technical data for F-30-900-50/51/52	
Dimensions	1 charging slot: 157 x 140 x 79 mm 2 charging slots: 240 x 190 x 130 mm 4 charging slots: 520 x 190 x 130 mm
Weight	1 charging slot: 1,740 g 2 charging slots: 4,939 g 4 charging slots: 8,700 g
Model	Li-ion battery charging unit
Input	100–240 V AC 50–60 Hz 0.9 A
Output	16.8 V DC 2.0 A

bee-system II







Accessories



Accessories for bee-system II		Product no.
	Perforated basket with lid, for 1 machine without rinsing set, reusable	F-31-910-13
	Perforated basket with lid, for 2 machines without rinsing set, reusable	F-31-910-18
	Rinsing set reusable	F-30-910-40
	Cleaning brush set reusable	F-30-910-50
	Hi Tech Oil Pen	F-30-900-61
	Sterile insert For using the F-30-900-00 power pack under sterile conditions, reusable	F-30-900-20
	Lubrication stand reusable	F-30-900-10
	POAG cable for charging units for connecting F-30-900-50 or F-30-900-51 or F-30-900-52 to the potential equalization	F-30-900-57

V124 || Subject to modifications. Please note that some products may not be available in all countries. Please always take note of the information that is provided with the product. For more detailed information, please consult with your contact partner or directly with Richard Wolf GmbH.

HF CONNECTION CABLE MONO 815xxx









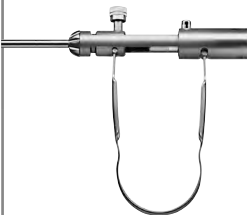

Instrument connector	Device connector		Product no.
<p>WOLF Resectoscopes</p> 		<p>HF connection cable mono L 3 m</p>	<p>815.032</p>
	<p>ERBE (ACC/ICC/IO)/BOWA (EU) R. Wolf HF surgical generator 400 kHz 2260002</p>	<p>HF connection cable mono L 5 m</p>	<p>815.052</p>
		<p>HF connection cable mono L 3 m</p>	<p>815.132</p>
	<p>ERBE (T series)</p>	<p>HF connection cable mono L 5 m</p>	<p>815.152</p>
<p>HF electrodes, monopolar</p> 		<p>HF connection cable mono L 3 m</p>	<p>815.031</p>
	<p>Martin (M-version)/Berchtold/ Aesculap</p>	<p>HF connection cable mono L 5 m</p>	<p>815.051</p>
		<p>HF connection cable mono L 3 m</p>	<p>815.033</p>
	<p>Bovie/Valleylab/Erbe (Int.)/ BOWA (Int.) R. Wolf HF surgical generator 400 kHz 2260001</p>	<p>HF connection cable mono L 5 m</p>	<p>815.053</p>
		<p>HF connection cable mono L 3 m</p>	<p>815.034</p>
	<p>BOWA (Int./EU) Eschmann and other devices with 4 mm plugs R. Wolf HF surgical generator 400 kHz 2260001</p>	<p>HF connection cable mono L 5 m</p>	<p>815.054</p>

HF CONNECTION CABLE MONO 8106xxx





Instrument connector	Device connector		Product no.
WOLF Instruments/surgical generator 	 <p>ERBE (ACC/ICC/IO)/BOWA (EU) R. Wolf HF surgical generator 400 kHz 2260002</p>	HF connection cable mono L 3 m	8106.032
		HF connection cable mono L 5 m	8106.052
	 <p>ERBE (T series)</p>	HF connection cable mono L 3 m	8106.132
		HF connection cable mono L 5 m	8106.152
HF electrodes, monopolar 	 <p>Martin (M-version)/Berchtold/ Aesculap</p>	HF connection cable mono L 3 m	8106.031
		HF connection cable mono L 5 m	8106.051
	 <p>Bovie/Valleylab/Erbe (Int.)/ BOWA (Int.) R. Wolf HF surgical generator 400 kHz 2260001</p>	HF connection cable mono L 3 m	8106.033
		HF connection cable mono L 5 m	8106.053
	 <p>BOWA (Int./EU) Eschmann and other devices with 4 mm plugs R. Wolf HF surgical generator 400 kHz 2260001/2260002</p>	HF connection cable mono L 3 m	8106.034
HF connection cable mono L 5 m		8106.054	

BIPO HF CONNECTION CABLE

8108xxx

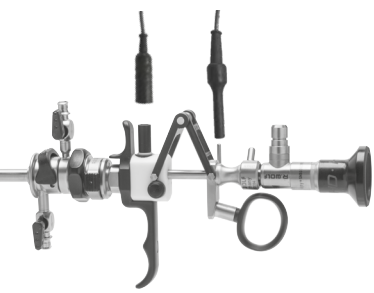

Instrument connector	Device connector		Product no.	
WOLF Bipolar forceps 	 ERBE (ACC/ICC/T)/BOWA (EU) R. Wolf HF surgical generator 400 kHz 2260001/2260002	HF connection cable bipo; L 3 m	8108.032	
		HF connection cable bipo; L 5 m	8108.052	
	 International / 2-pin Valleylab R. Wolf HF surgical generator 400 kHz 2260001/2260002	HF connection cable bipo; L 3 m	8108.033	
		HF connection cable bipo; L 5 m	8108.053	
	 WOLF/Martin (M-version)/ Berchtold/Aesculap	HF connection cable bipo; L 3 m	8108.031	
		HF connection cable bipo; L 5 m	8108.051	
	 EMC Dolley	HF connection cable bipo; L 3 m	8108035	
	Bipolar tweezers connection 	 ERBE (ACC/ICC/T)/BOWA (EU) R. Wolf HF surgical generator 400 kHz 2260001/2260002	HF connection cable bipo; L 3 m	8108.132
			HF connection cable bipo; L 5 m	8108.152
		 International / 2-pin Valleylab R. Wolf HF surgical generator 400 kHz 2260001/2260002	HF connection cable bipo; L 3 m	8108.133
HF connection cable bipo; L 5 m			8108.153	
 Martin (M-version)/Berchtold/ Aesculap		HF connection cable bipo; L 3 m	8108.131	
		HF connection cable bipo; L 5 m	8108.151	
 EMC Dolley		HF connection cable bipo; L 3 m	8108135	

HF CONNECTION CABLE BIPO FOR RESECTION IN SALINE SOLUTION

Instrument connector	Device connector		Product no.
<p>WOLF S(a)line resectoscopes</p> 	 Erbe VIO 300D	<p>Bipolar cable; TUR/TCR; WOLF</p> <p>MF plug; L 4 m</p>	<p>20196-119</p>
	 Erbe VIO 3	<p>Bipolar cable; MF-U</p> <p>MF plug; L 4.5 m</p>	<p>21196-119</p>
	 KLS Martin	<p>HF connection cable bipo; L 3 m</p>	<p>8108.231</p>
		<p>HF connection cable bipo; L 5 m</p>	<p>8108.251</p>
	 R. Wolf HF surgical generator 400 kHz 2260001/2260002	<p>HF connection cable bipo; L 3 m</p>	<p>8108233</p>
		<p>HF connection cable bipo; L 5 m</p>	<p>8108253</p>

VI24 || Subject to modifications. Please note that some products may not be available in all countries. Please always take note of the information that is provided with the product. For more detailed information, please consult with your contact partner or directly with Richard Wolf GmbH.

MONO HF NEUTRAL ELECTRODE CABLE

Instrument connector	Device connector		Product no.
<p>2-pole neutral electrode</p> 	 <p>R. Wolf HF surgical generator 400 kHz 2260001/2260002</p>	<p>Mono HF neutral electrode cable, L 4.5 m</p>	<p>2260031</p>

V124 || Subject to modifications. Please note that some products may not be available in all countries. Please always take note of the information that is provided with the product. For more detailed information, please consult with your contact partner or directly with Richard Wolf GmbH.

THORACIC ENDOSCOPY

1

BRONCHOSCOPY

2

PEDIATRIC BRONCHOSCOPY

3

THORACOSCOPY

4

MEDIASTINOSCOPY

4.1

VIDEO MEDIASTINOSCOPE

4.2

FORCEPS / SCISSORS / CANNULAS

4.3

HF SUCTION DEVICES

SPREADABLE VIDEO MEDIASTINOSCOPE with distal and parallel expandable spatula

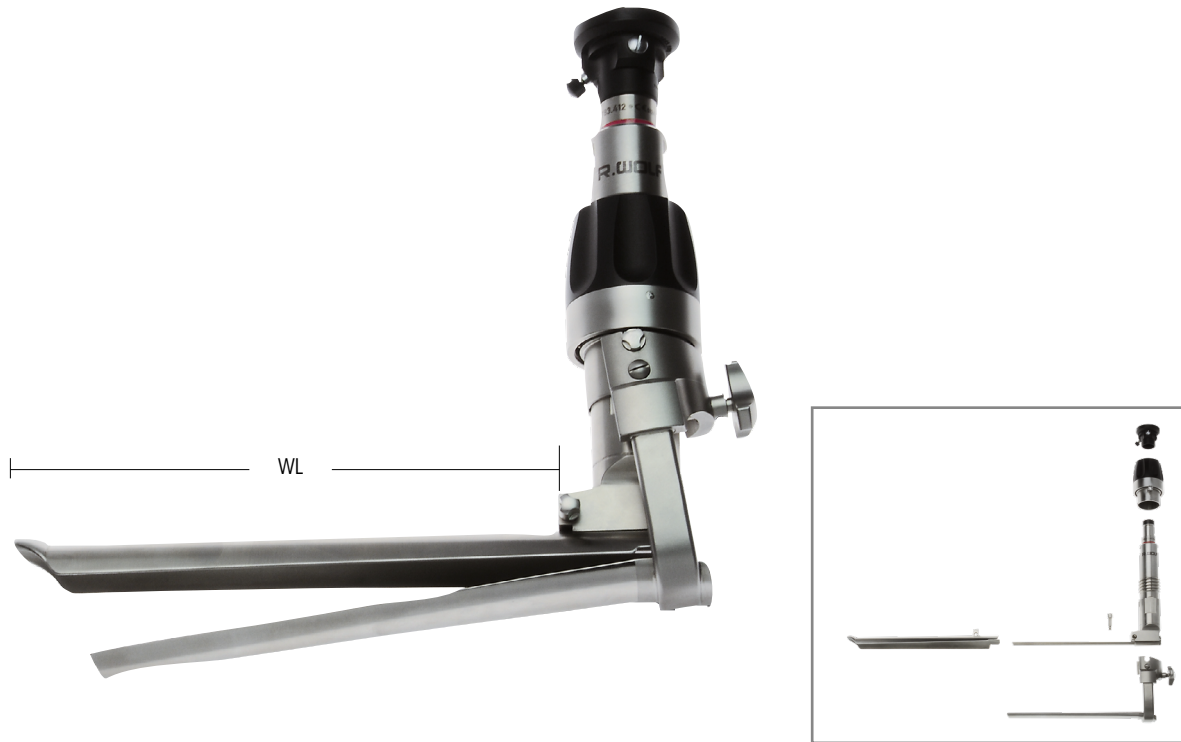

with distal and parallel expandable spatula	WL	Product no.
<p>Video mediastinoscope bndl consisting of: Video mediastinoscope WL 158 mm (8783.412) Suction irrigation tube OD 2.5 mm WL 165 mm (8783.721) and tool wrench (9500119) Can be disassembled</p>	158 mm	8783.4121

for this:		Product no.
Suction tube OD 3.2 mm TL 176 mm		8783.701

VIDEO MEDIASTINOSCOPE

VIDEO MEDIASTINOSCOPE

4.1

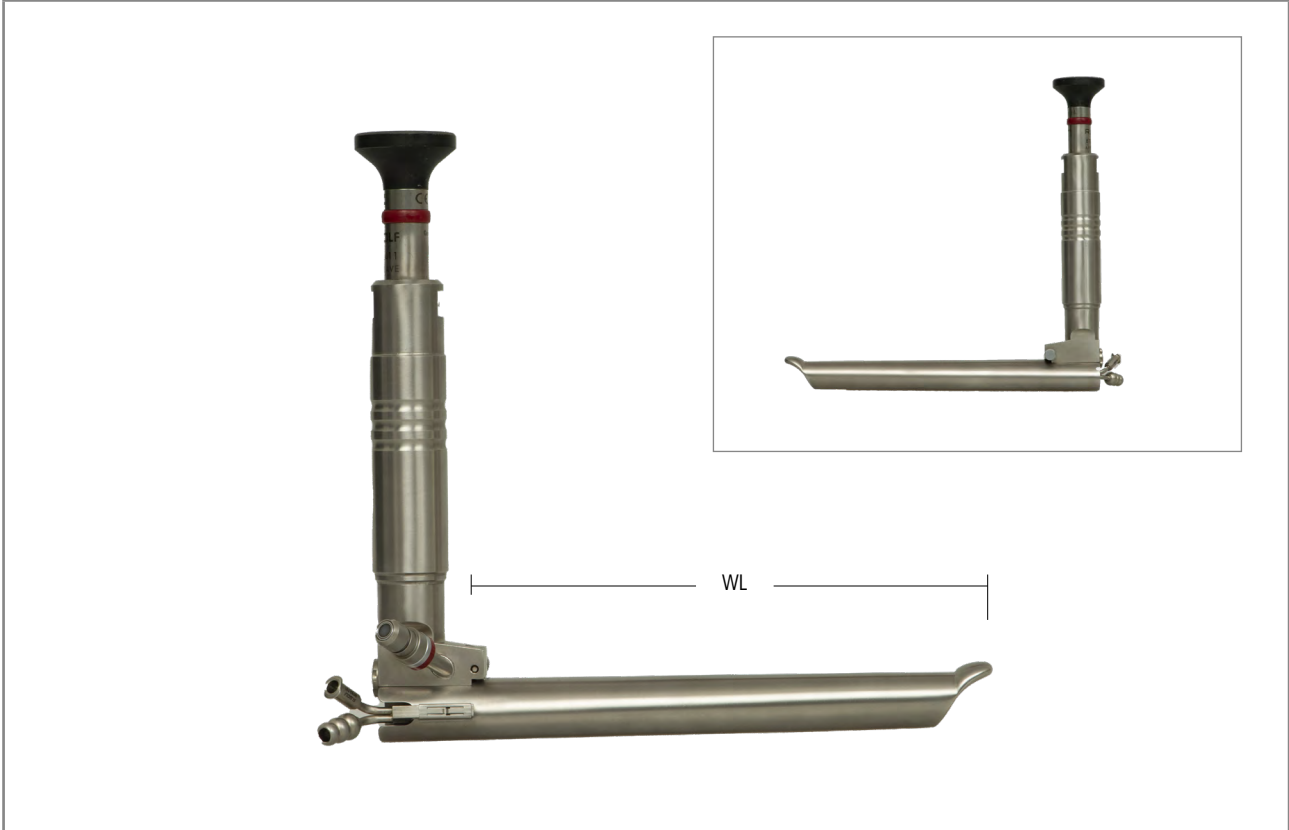

	WL	Product no.
Video mediastinoscope bndl consisting of: Video mediastinoscope WL 160 mm (8784.411) Suction irrigation tube OD 2.5 mm WL 165 mm (8783.721)	160 mm	8784.4111

For this:		Product no.
Suction tube OD 3.2 mm TL 176 mm		8783.701

V124 || Subject to modifications. Please note that some products may not be available in all countries. Please always take note of the information that is provided with the product. For more detailed information, please consult with your contact partner or directly with Richard Wolf GmbH.

VIDEO MEDIASTINOSCOPE ACCESSORIES

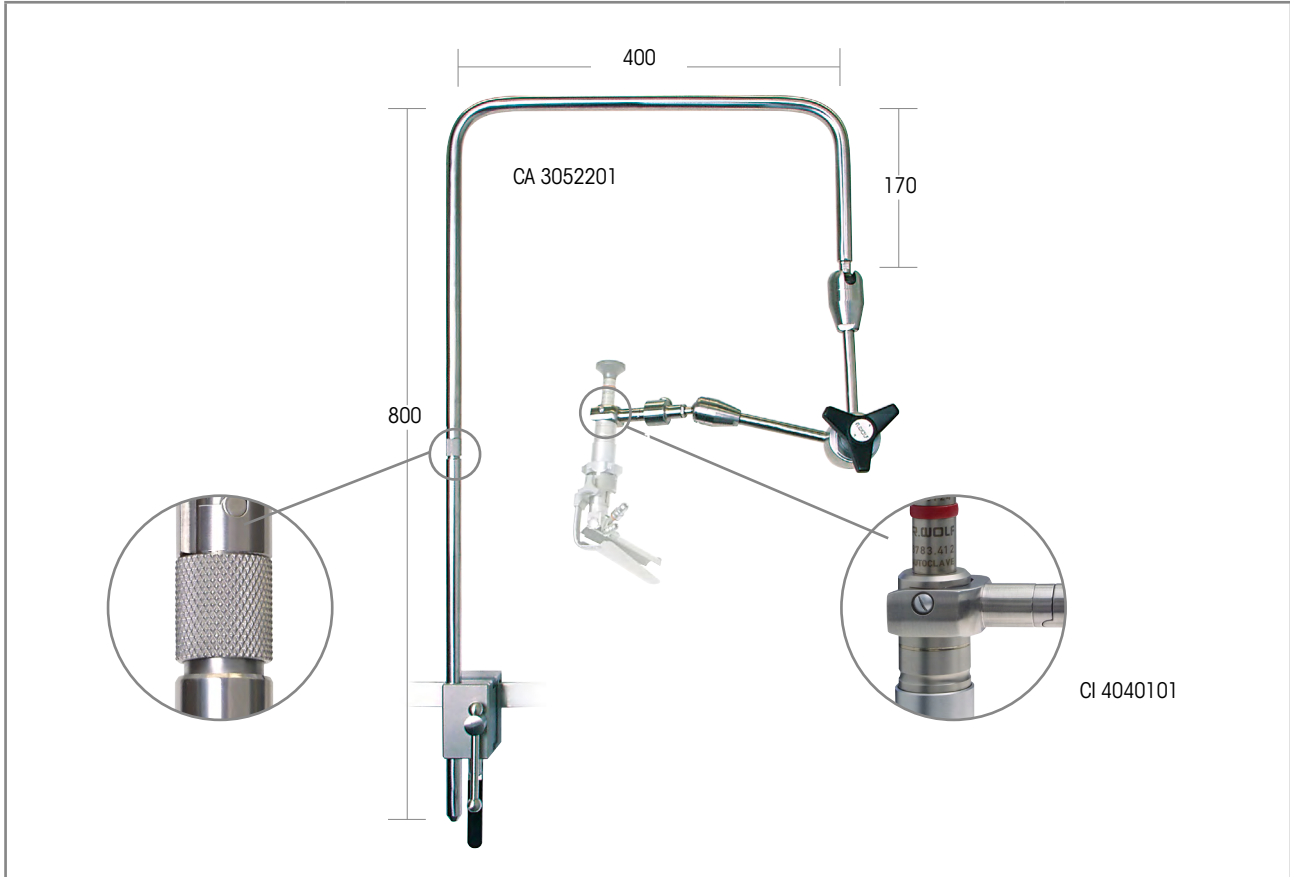









U-shaped support arm for attachment to the operating table (standard rail):		Product no.
HERCULES® arm systems R310 mm	detachable U-Stand 800 x 400 x 170 mm quick release adapter suitable for universal use for attachment to the operating table (standard rail), reusable	CA 3052201
HERCULES® fork mount	for mounting video mediastinoscope (8783.412 / 8784.411) on support arm (CA 3052201), reusable	CI 4040101

Recommended accessories		Product no.
Perforated basket for video mediastinoscope	(W x H x D) 265 x 85 x 250 mm	38007
Fiber light cable bndl consisting of: Fiber light cable (80663523), projector-side adapter (8095.07), and endoscope-side adapter (809509)	Ø 3.5 mm, 2.3 m long	806635231

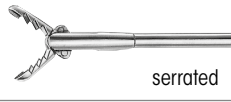

VI24 || Subject to modifications. Please note that some products may not be available in all countries. Please always take note of the information that is provided with the product. For more detailed information, please consult with your contact partner or directly with Richard Wolf GmbH.







FORCEPS 3 MM / SPONGE FORCEPS 3 MM

						
				Ø	WL	Product no.
 rippled	Grasping forceps, small WL 230 mm			3.0 mm	230 mm	8283.51
 rippled	Grasping forceps, medium WL 245 mm			3.0 mm	245 mm	8283.52
 rippled	Grasping forceps, large WL 240 mm			3.0 mm	240 mm	8283.53
		Sheath Ø	Jaw section Ø	WL	Product no.	
 serrated	Biopsy forceps WL 270 mm			3.0 mm	4.0 mm	8280.22
 severing	Tumor forceps WL 270 mm			3.0 mm	4.0 mm	8280.26
						
				Outer Ø	WL	Product no.
	Sponge forceps Ø 3.0 mm WL 300 mm			3.0 mm	300 mm	8148.02

ERAGON modular mini

Ø 3.5 MM, INSULATED

		Handle, axial	
ERAGON axial			
All jaw inserts and sheath tubes can also be combined with ERAGONaxial.		without lock, with HF connector	without lock, with HF connector
Rotatable knob	Product no.	83930083	83930084
	8988	.	.

Jaw insert		Sheath tube, Ø 3.5 mm, insulated		Complete instrument • Jaw insert with sheath tube • Handle		
						
		WL 240 mm	WL 330 mm	with lock, with HF, mono		
	JL*	Product no.	8390933	8391933	83930074	Product no.
 15 mm	Dissector forceps mono Ø 3.5 mm bndl	8390207	.	.	.	83902077
		8391207	.	.	.	83912077
 18 mm	Dissector forceps mono Ø 3.5 mm bndl	8390221	.	.	.	83902217
		8391221	.	.	.	83912217
 14 mm	Dissector forceps mono Ø 3.5 mm bndl	8390222	.	.	.	83902227
		8391222	.	.	.	83912227
 14 mm	Dissector forceps mono Ø 3.5 mm bndl	8390223	.	.	.	83902237
		8391223	.	.	.	83912237

* JL = jaw length when jaw section closed (approximate measurements)









HF connection cable: see page THORAX105/106

ERAGON modular mini

Ø 3.5 MM, INSULATED

FORCEPS





4.2

Jaw insert			Sheath tube, Ø 3.5 mm, insulated		Handle, pistol-shaped		Complete instrument
							<ul style="list-style-type: none"> Jaw insert with sheath tube Handle
							WL 240 mm
	JL*	Product no.	8390933	8391933	83930073	83930074	Product no.
 Metzenbaum scissors mono Ø 3.5 mm bndl	16 mm	8390215	•		•		83902157
		8391215			•		83912157
 Metzenbaum scissors mono Ø 3.5 mm bndl fine-toothed, curved, double-action	14 mm	8390224	•		•		83902247
		8391224			•		83912247
 Hook scissors mono Ø 3.5 mm bndl single-action	8 mm	8390227	•		•		83902277
		8391227			•		83912277
 Double spoon forceps mono Ø 3.5 mm bndl	12 mm	8390216	•			•	83902167
		8391216			•		83912167
 Friedel punch mono Ø 3.5 mm bndl	10 mm	8390217	•			•	83902177
		8391217			•		83912177

Accessories for manual and machine reprocessing		Product no.
	Irrigation adapter Ø 9 mm, length 64 mm	163502

ERAGON modular

Ø 5,0 MM, INSULATED

Jaw insert			Sheath tube, Ø 5.0 mm, insulated	Handle, pistol-shaped	Complete instrument • Jaw insert with sheath tube • Handle
					
			SL 260 mm	with lock, with HF, mono	
	JL*	Product no.	8392933	83930074	Product no.
 <p>Atraumatic grasping forceps mono Ø 5 mm bndl fenestrated, with cross toothing, double-action</p>	19 mm	8392.181	•	•	83921817



FORCEPS
4.2

Accessories for manual and machine reprocessing		Product no.
	<p>Irrigation adapter Ø 9 mm, length 64 mm</p>	163502

V124 || Subject to modifications. Please note that some products may not be available in all countries. Please always take note of the information that is provided with the product. For more detailed information, please consult with your contact partner or directly with Richard Wolf GmbH.

HF COAGULATION SUCTION TUBE



monopolar		Ø	WL	Product no.
	HF coag. suction tube OD 3.1 mm WL 210 mm	3.1 mm	210 mm	8291.101
	HF coag. suction tube OD 4.1 mm WL 210 mm	4.1 mm		8291.102
	HF coag. suction tube OD 4.2 mm WL 230 mm	4.2 mm	230 mm	84420.2007
	HF coag. suction tube OD 5.2 mm WL 230 mm	5.2 mm	230 mm	84420.4007





Bipolar		Ø	WL	Product no.
	HF coag. suction tube OD 4.5 mm WL 250 mm	4.5 mm	250 mm	8188.02

HF connection cable and bipolar connection cable: see page THORAX105-109

HF COAGULATION SUCTION TUBE / SUCTION TUBE



		Ø	WL	Product no.
	HF coag. suction tube OD 5.2 mm WL 240 mm	5.2 mm	240 mm	84420.2105
	HF coag. suction tube OD 5.2 mm WL 240 mm			84420.2107

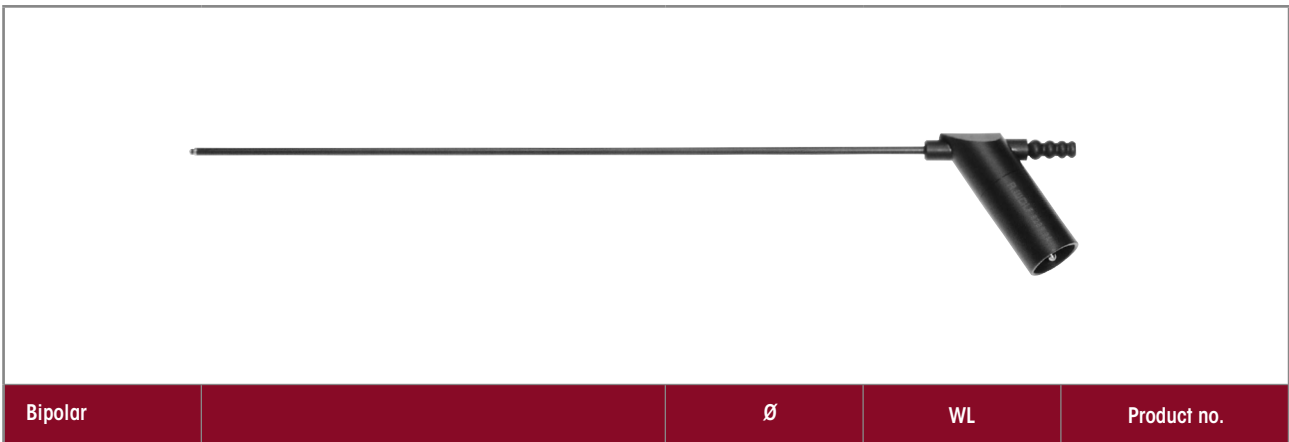

Bipolar		Ø	WL	Product no.
	Suction tube, bipo Ø 3.2 mm WL 240 mm	3.2 mm	240 mm	8289.24

HF connection cable and bipolar connection cable: see page THORAX105-109

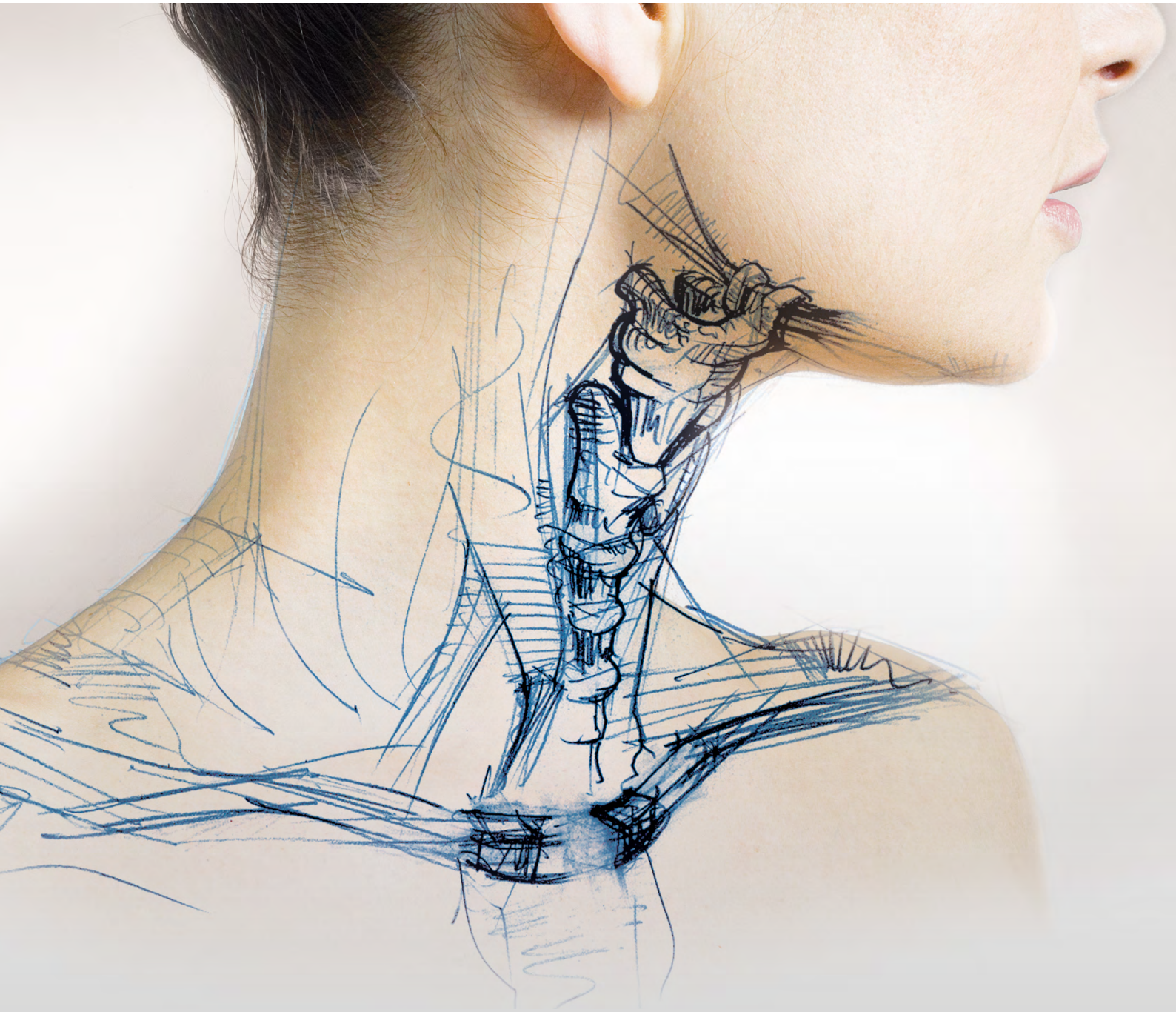

LARYNGOSCOPY

LARYNGOSCOPY

-
- 1.1 FIBER NPL ENDOSCOPE / MAGNIFYING LARYNGO-PHARYNGOSCOPE
-
- 1.2 PANOVVIEW TELESCOPE
-
- 1.3 LARYNGOSCOPES / CHEST SUPPORTS
-
- 1.4 RASPING FORCEPS / SPOON FORCEPS
-
- 1.5 SCISSORS
-
- 1.6 PROBE / KNOT PUSHER / KNIFE
-
- 1.7 SUCTION TUBES
-
- 1.8 NEEDLE CARRIER INSTRUMENT
-
- 1.9 HF CONNECTION CABLE (MONOPOLAR/BIPOLAR)
-

FIBER NPL ENDOSCOPE

3.5 MM

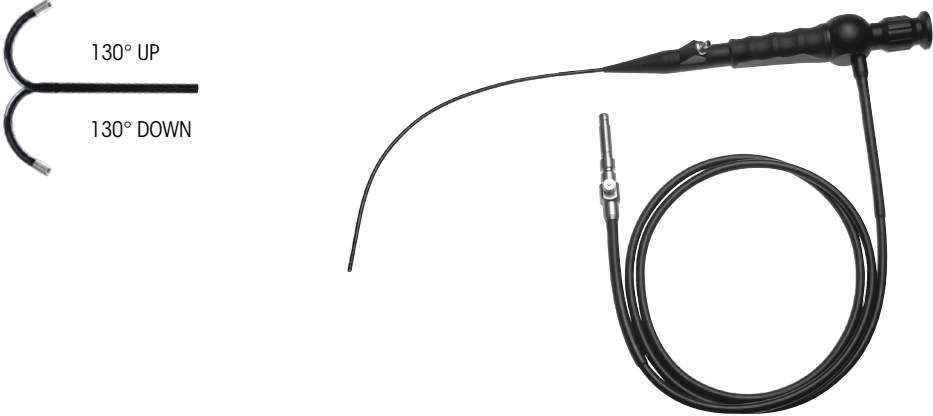









	Ø	Working channel	Direction of view	Angle of view	WL	TL	Product no.
Fiber NPL endoscope Ø 3.5 mm WL 300 mm	3.5 mm	1.2 mm	0°	90°	300 mm	570 mm	7223.001
Fiber NPL endoscope Ø 3.5 mm WL 300 mm	3.5 mm	-	0°	80°	300 mm	525 mm	7224.001

Technical data	
Sheath Ø	3.5 mm
Working channel Ø	Ø 1.2 mm (7223.001)
Angulation	130° upward, 130° downward
Resolution	82,000 pixels
Fiber optics cables	Permanently connected
Eyepiece	ISO standard
Angle of view	7223.001: 80° 7224.001: 90°
Direction of view	0°
Operating conditions	+10 °C to +30 °C, 20 % to 75 % rel. humidity, atmospheric pressure 700 hPa to 1,060 hPa
Storage and transport conditions	-20 °C to +60 °C, 10 % to 90 % rel. humidity, atmospheric pressure 700 hPa to 1,060 hPa

FIBER NPL ENDOSCOPE

ACCESSORIES AND AUXILIARY INSTRUMENTS



Recommended accessories		Outer Ø	WL	Product no.
Button electrode flex. mono Ø 1.1 mm WL 600 mm		Ø 1,1mm	600 mm	7223.911
Flex. biopsy forceps Ø 1 mm WL 600 mm		Ø 1mm	600 mm	7223.60
Flex. grasping forceps Ø 1 mm WL 600 mm		Ø 1mm	600 mm	7223.65
Biopsy valve holder (for sealing valve 15114.052)				15114175
Sealing valve cpl. (20 PCS)				15114.052
Irrigation and probe attachment				7265.751
Leak tester for flexible endoscopes				163.903
Pressure equalization valve for low-temperature sterilization procedure with n hydrogen peroxide H2O2 and n Low Temperature Steam Formaldehyde (LTSF)				163.904

	Product no.
 <p>Sterilization basket for flexible endoscopes (W x H x D): 448 x 288 x 106 mm</p>	33016

LARYNGO-PHARYNGOSCOPE

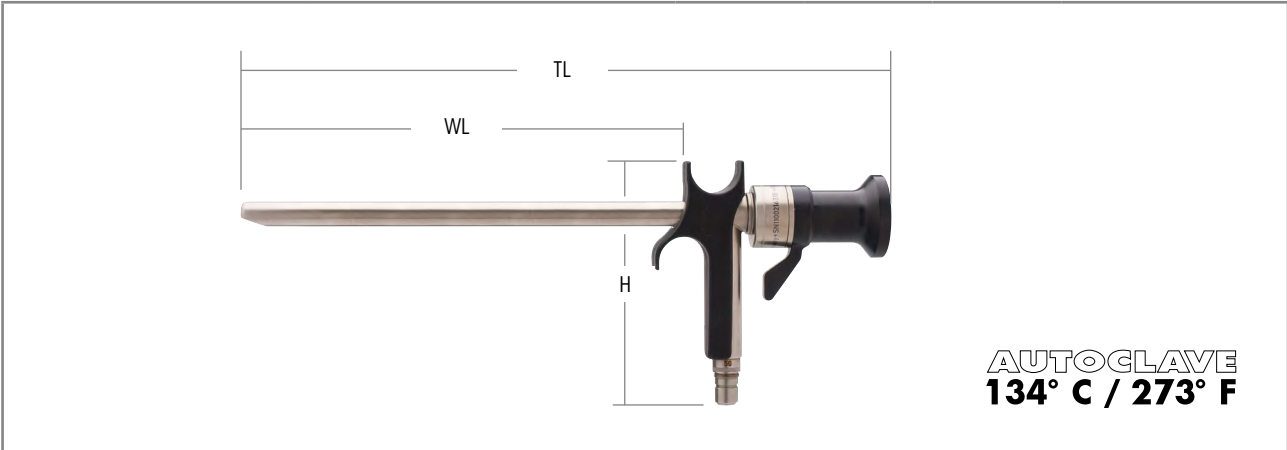
Lula 2.0



		TL	WL	H	Product no.
	Laryngo-pharyngoscope 70° Ø 10 mm WL 168 mm	245 mm	168 mm	93.2 mm	885070
	Laryngo-pharyngoscope 90° Ø 10 mm WL 161 mm	237 mm	161 mm	93.2 mm	885090

Recommended accessories	Product no.
Fiber light cable bndl consisting of: fiber light cable (80665023), projector-side adapter (8095.07), and endoscope-side adapter (809509)	Ø 3.5 mm, 2.3 m long 806650231

Laryngo-pharyngoscope
1.1

V23 || Subject to modifications. Please note that some products may not be available in all countries. Please always take note of the information that is provided with the product. For more detailed information, please consult with your contact partner or directly with Richard Wolf GmbH.

PANOVIEW TELESCOPE
Ø 4 MM

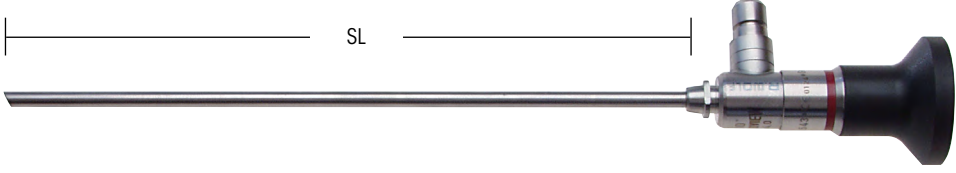

AUTOCLAVE
134° C / 273° F

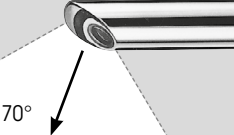
		Ø	WL	TL	Product no.
	PANOVIEW Telescope 70° Ø 4mm SL 176mm	4 mm	176 mm	238 mm	8880.545

Recommended accessories		Product no.
Perforated basket for standard telescope 1	(W x H x D) 297 x 54 x 59 mm	38015
Fiber light cable bndl consisting of: fiber light cable (80663523), projector-side adapter (8095.07), and endoscope-side adapter (809509)	Ø 3.5 mm, 2.3 m long	806635231

LARYNGOSCOPES

OVERVIEW

		Operating		Operating micro		Universal		SubTLo- foscope / pediatric	Operating								
		laryngoscopes															
		8446.221	8449.121	8449.221	8449.321	8456.011	8457.0111	82420.0000	8456.1011	8458.031	8458.011	824201000	824202000	824203000	824204000		
Laryngoscope	8446.22	•															
	8449.12		•														
	8449.22			•													
	8449.32				•												
	8456.01					•											
	8457.011						•										
	8456.101							•									
	8458.03								•								
Light rod	8456.90	•				•	•	•	•		•						
	8458.92									•		•					
	824201001													•	•		
	824202001											•					
Insufflation and suction tube	8456.95	•				•	•	•	•		•						
	8458.97									•		•					
	824201002													•	•		
	824202002											•					
Light rod	8449.11		•	•										•	•		
	8449.31				•							•					
Insufflation and suction tube	824202011											•					
	824201012										•						
	824202012											•					
	824203012													•	•		

OPERATING LARYNGOSCOPE

CAN BE USED WITH EITHER INTERNAL OR EXTERNAL LIGHT ROD AND INSUFFLATION / SUCTION TUBE

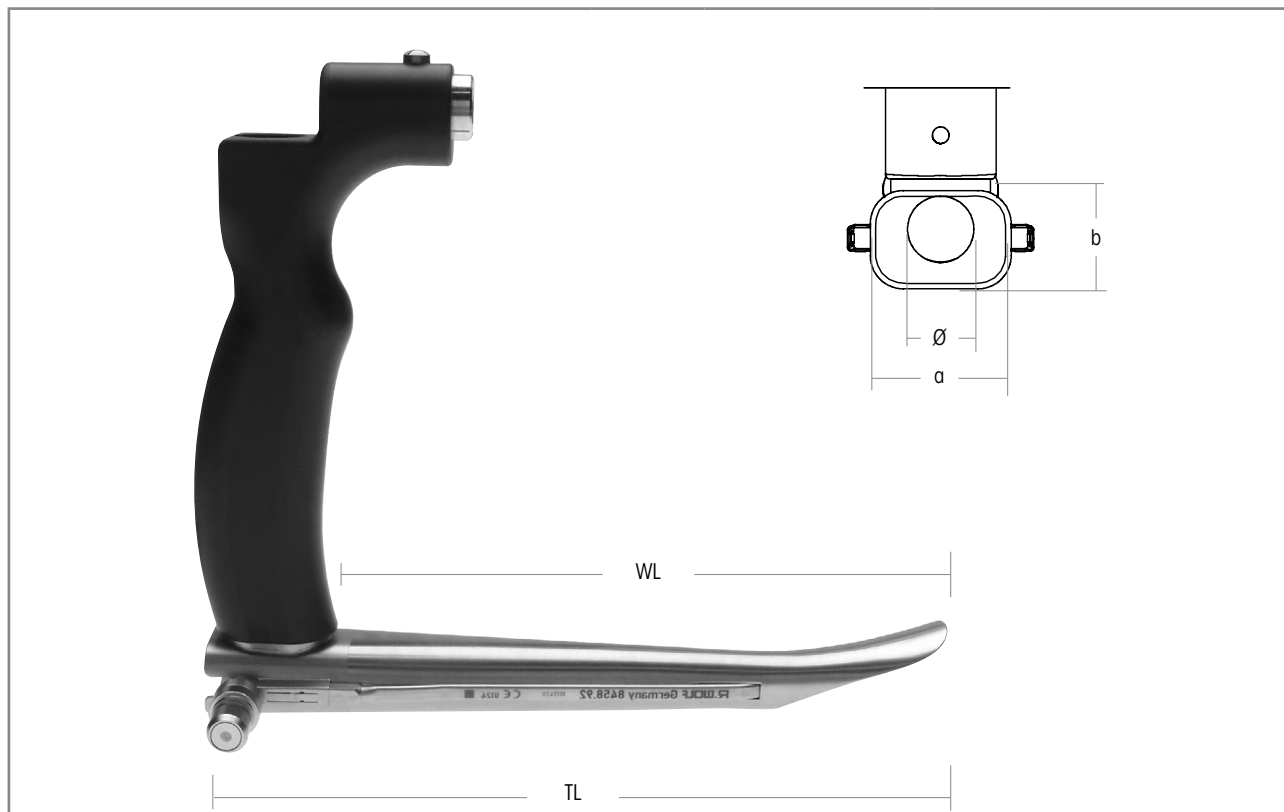

	Outer dimensions		WL	TL	Product no.
	distally Ø	proximally a x b			
OP-Laryngoscope WL 142mm with universal handle for all support and holding systems	12 mm	25.5 mm x 18 mm	142 mm	170 mm	824201000

Required:	Product no.
External	
Light rod for laryngoscope	8458.92
Insufflation / suction tube TL 124 mm	8458.97
Internal	
Light rod for laryngoscope	8449.31
Insufflation / suction tube TL 102 mm	824201012
Chest support for operating laryngoscopes 	8449.911

V23 | Subject to modifications. Please note that some products may not be available in all countries. Please always take note of the information that is provided with the product. For more detailed information, please consult with your contact partner or directly with Richard Wolf GmbH.

OPERATING LARYNGOSCOPE

CAN BE USED WITH EITHER INTERNAL OR EXTERNAL LIGHT ROD AND INSUFFLATION / SUCTION TUBE

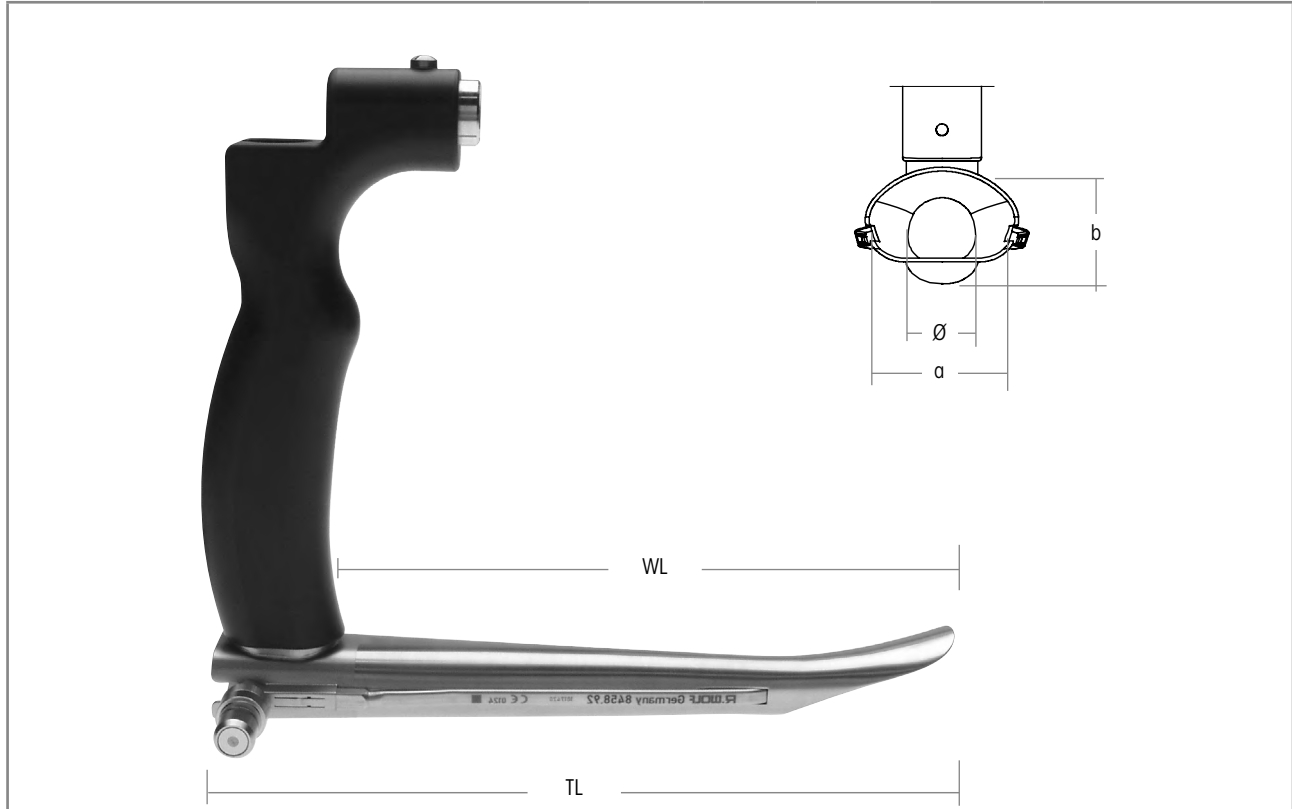

	Outer dimensions		WL	TL	Product no.
	distally Ø	proximally a x b			
Operating laryngoscope WL 123 mm with universal handle for all support and holding systems	17.5 mm	39 mm x 24 mm	123 mm	150 mm	824202000

Required:	Product no.
External	
Light rod for laryngoscope	824202001
Insufflation / suction tube TL 1 mm	824202002
Internal	
Light rod for laryngoscope	824202011
Insufflation / suction tube TL 97 mm	824202012
Chest support for operating laryngoscopes 	8449.911

V23 || Subject to modifications. Please note that some products may not be available in all countries. Please always take note of the information that is provided with the product. For more detailed information, please consult with your contact partner or directly with Richard Wolf GmbH.

OPERATING LARYNGOSCOPE

CAN BE USED WITH EITHER INTERNAL OR EXTERNAL LIGHT ROD AND INSUFFLATION / SUCTION TUBE

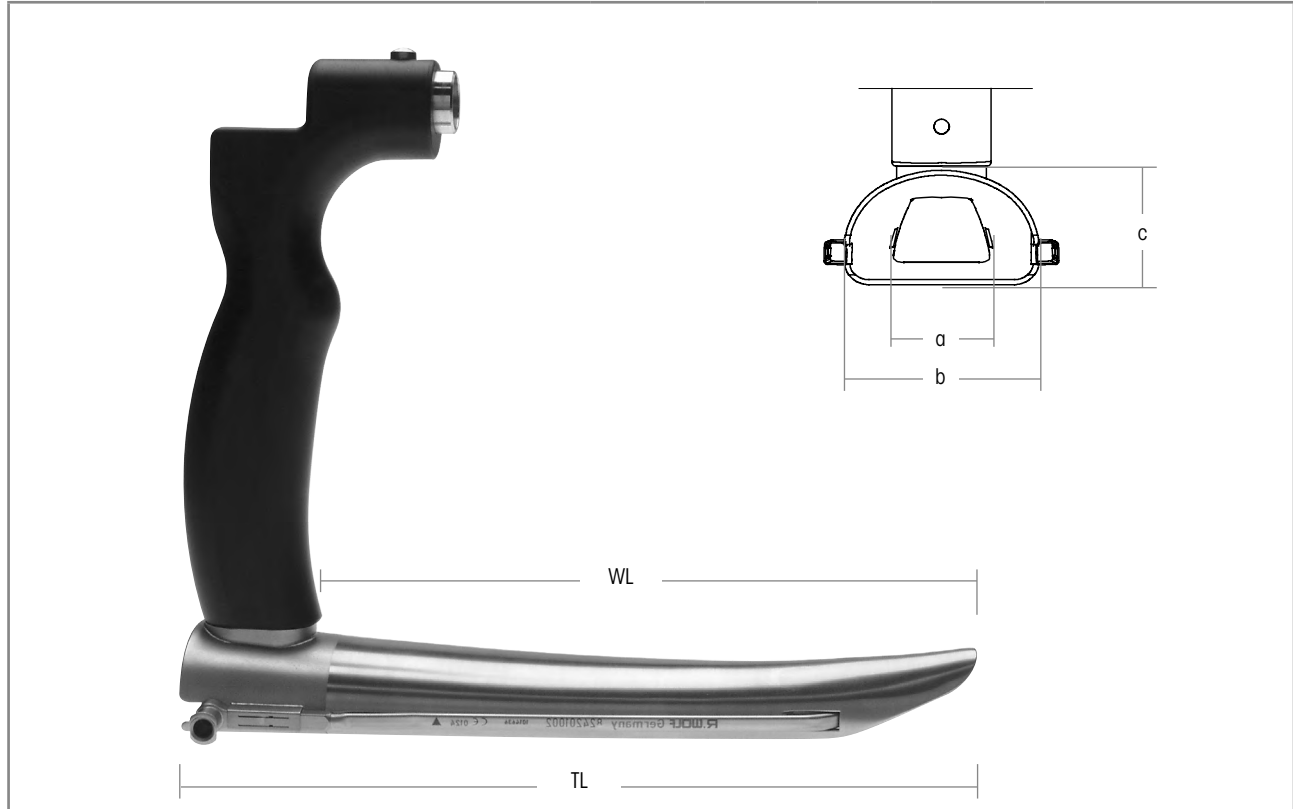

	Outer dimensions		WL	TL	Product no.
	distally a	proximally c x d			
Operating laryngoscope WL 152 mm with universal handle for all support and holding systems	13.5 mm	39 mm x 23 mm	152 mm	180 mm	824203000

Required:	Product no.
External	
Light rod for laryngoscope	824201001
Insufflation / suction tube TL 145 mm	824201002
Internal	
Light rod for laryngoscope	8449.11
Insufflation / suction tube TL 133 mm	824203012
Chest support for operating laryngoscopes 	8449.911

V23 || Subject to modifications. Please note that some products may not be available in all countries. Please always take note of the information that is provided with the product. For more detailed information, please consult with your contact partner or directly with Richard Wolf GmbH.

OPERATING LARYNGOSCOPE

CAN BE USED WITH EITHER INTERNAL OR EXTERNAL LIGHT ROD AND INSUFFLATION / SUCTION TUBE

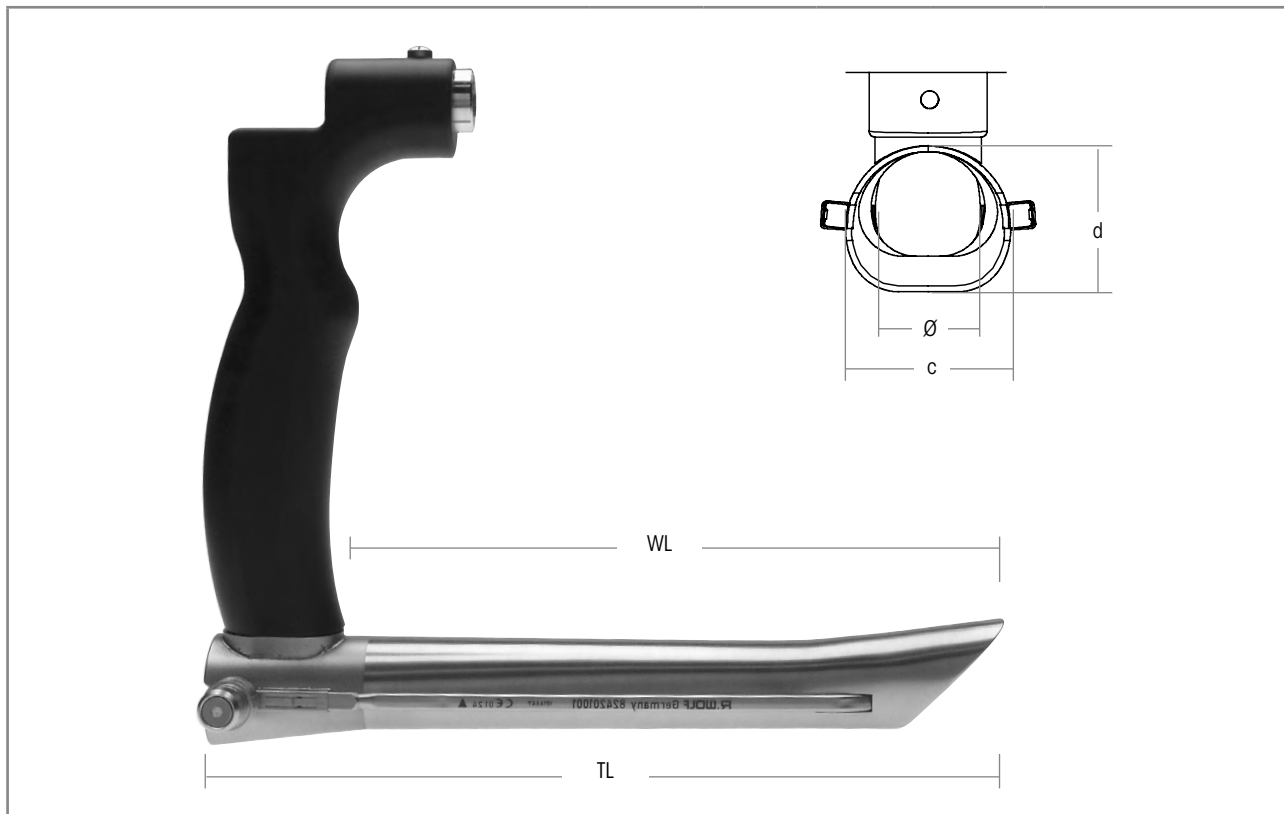

	Outer dimensions		WL	TL	Product no.
	distally Ø	proximally a x b			
OP-Laryngoscope WL 149mm with universal handle for all support and holding systems	16.5 mm	28 mm x 24.5 mm	149 mm	180 mm	824204000

Required:	Product no.
External	
Light rod for laryngoscope	824201001
Insufflation / suction tube TL 145 mm	824201002
Internal	
Light rod for laryngoscope	8449.11
Insufflation / suction tube TL 133 mm	824203012
Chest support for operating laryngoscopes	8449.911



LARYNGOSCOPE

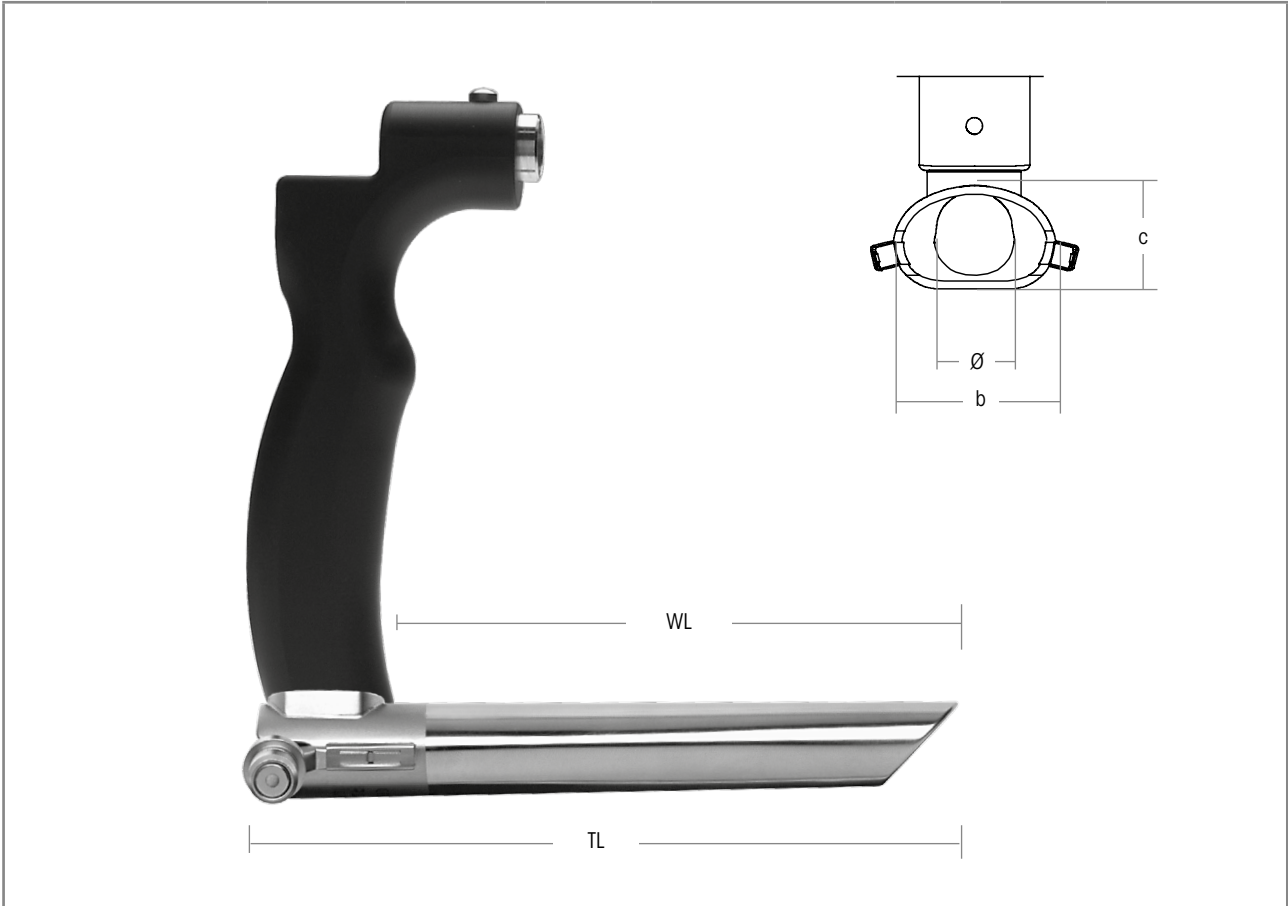

	OP-Micro-laryngoscope	Light rod for laryngoscope	Size	Inner dimensions	Outer dimensions	WL	TL	Product no.
				distally Ø	proximally c x d			
Laryngoscope bndl consisting of: operating microlaryngoscope and light rod for laryngoscope with universal handle for all support and holding systems	8449.32	8449.31	A	13 mm	21 mm x 14 mm	103 mm	134 mm	8449.321
	8449.22	8449.11	B	14.4 mm	26 mm x 16 mm	153 mm	184 mm	8449.221
	8449.12	8449.11	C	14 mm	30 mm x 20 mm	153 mm	183 mm	8449.121

Required:	Product no.
Chest support for operating laryngoscopes 	8449.911

OPERATING LARYNGOSCOPE FOR ANTERIOR CORRECTION

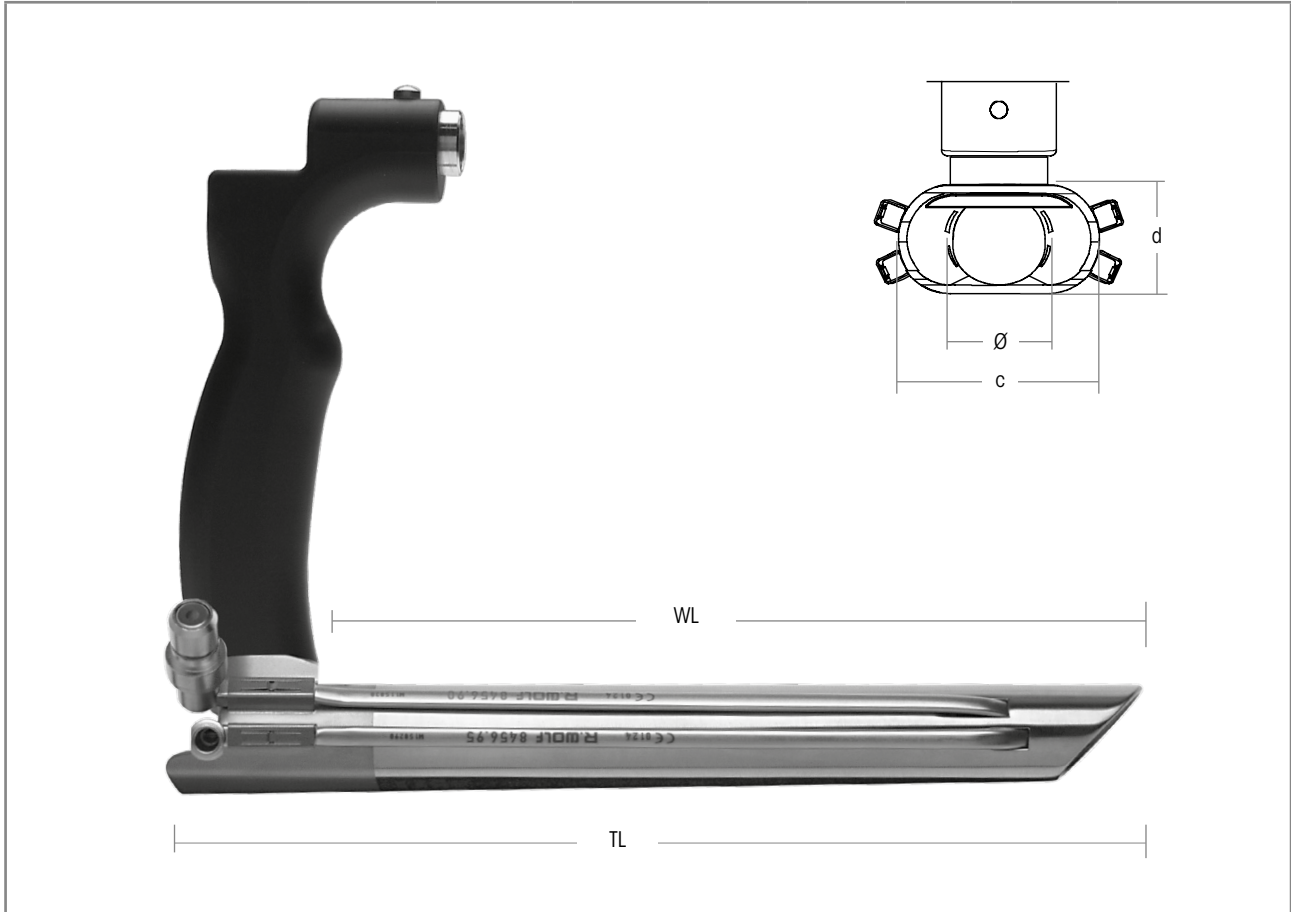

	Operating laryngoscope	Light rod for laryngoscope	Insufflation / suction tube	Inner dimensions		WL	TL	Product no.
				distally Ø	proximally c x d			
<p>Laryngoscope bndl consisting of: operating laryngoscope, light rod for laryngoscope, and insufflation / suction tube</p> <p>with universal handle for all support and holding systems</p>	8446.22	8456.90	8456.95	16 mm	32 mm x 15 mm	154 mm	184 mm	8446.221
Required:								Product no.
Chest support for operating laryngoscopes								8449.911

V23 || Subject to modifications. Please note that some products may not be available in all countries. Please always take note of the information that is provided with the product. For more detailed information, please consult with your contact partner or directly with Richard Wolf GmbH.

OPERATING LARYNGOSCOPE FOR ANTERIOR CORRECTION

LARYNGOSCOPES

1.3

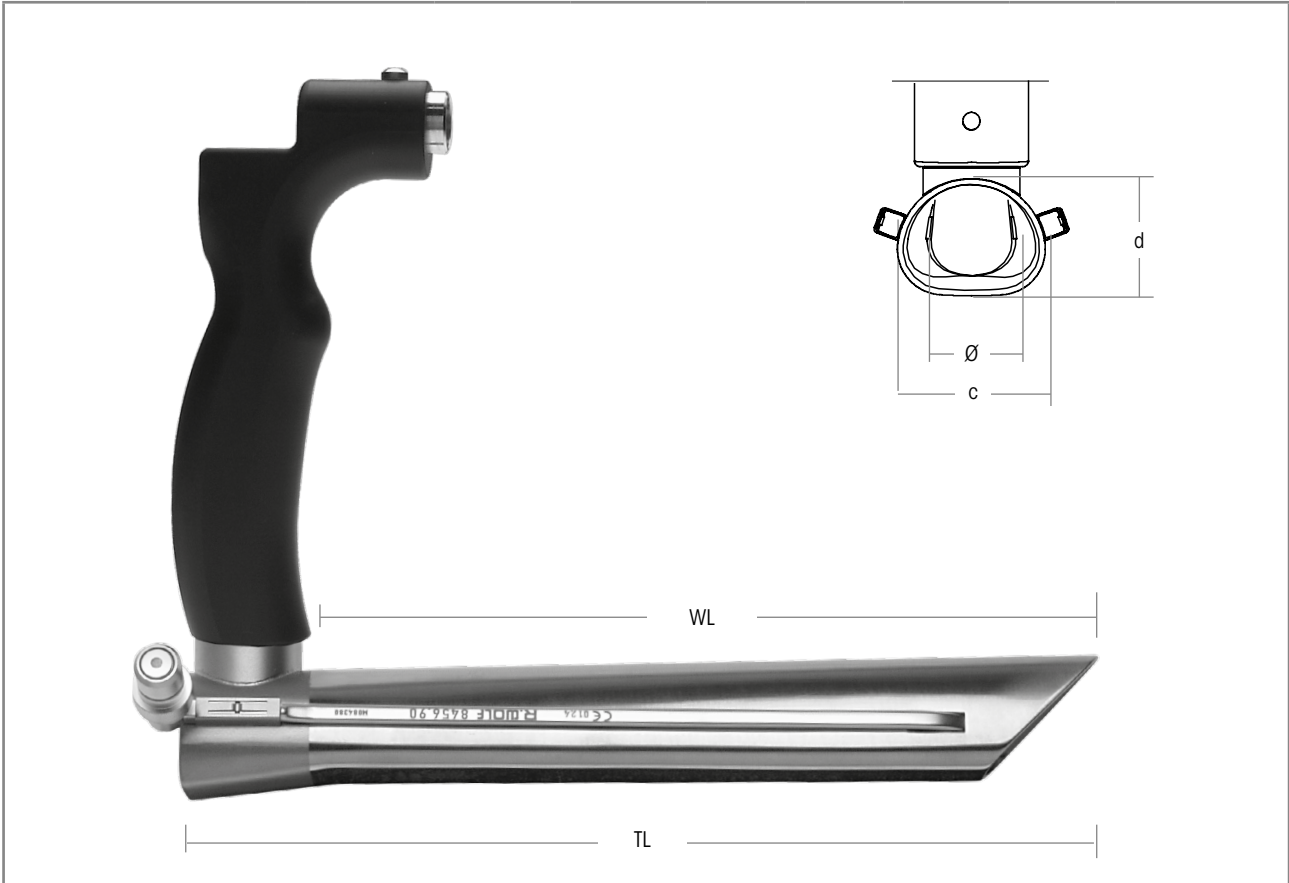

	Operating laryngoscope	Light rod for laryngoscope	Insufflation / suction tube	Inner dimensions		WL	TL	Product no.
				distally Ø	proximally c x d			
Laryngoscope bndl consisting of: operating laryngoscope, light rod for laryngoscope, and insufflation / suction tube with universal handle for all support and holding systems	8458.03	8458.92	8458.97 TL 124 mm	13 mm	24 mm x 19 mm	113 mm	144 mm	8458.031

Required:	Product no.
Chest support for operating laryngoscopes 	8449.911

V23 || Subject to modifications. Please note that some products may not be available in all countries. Please always take note of the information that is provided with the product. For more detailed information, please consult with your contact partner or directly with Richard Wolf GmbH.

SUBTLOTTOSCOPE

LARYNGOSCOPES
1.3

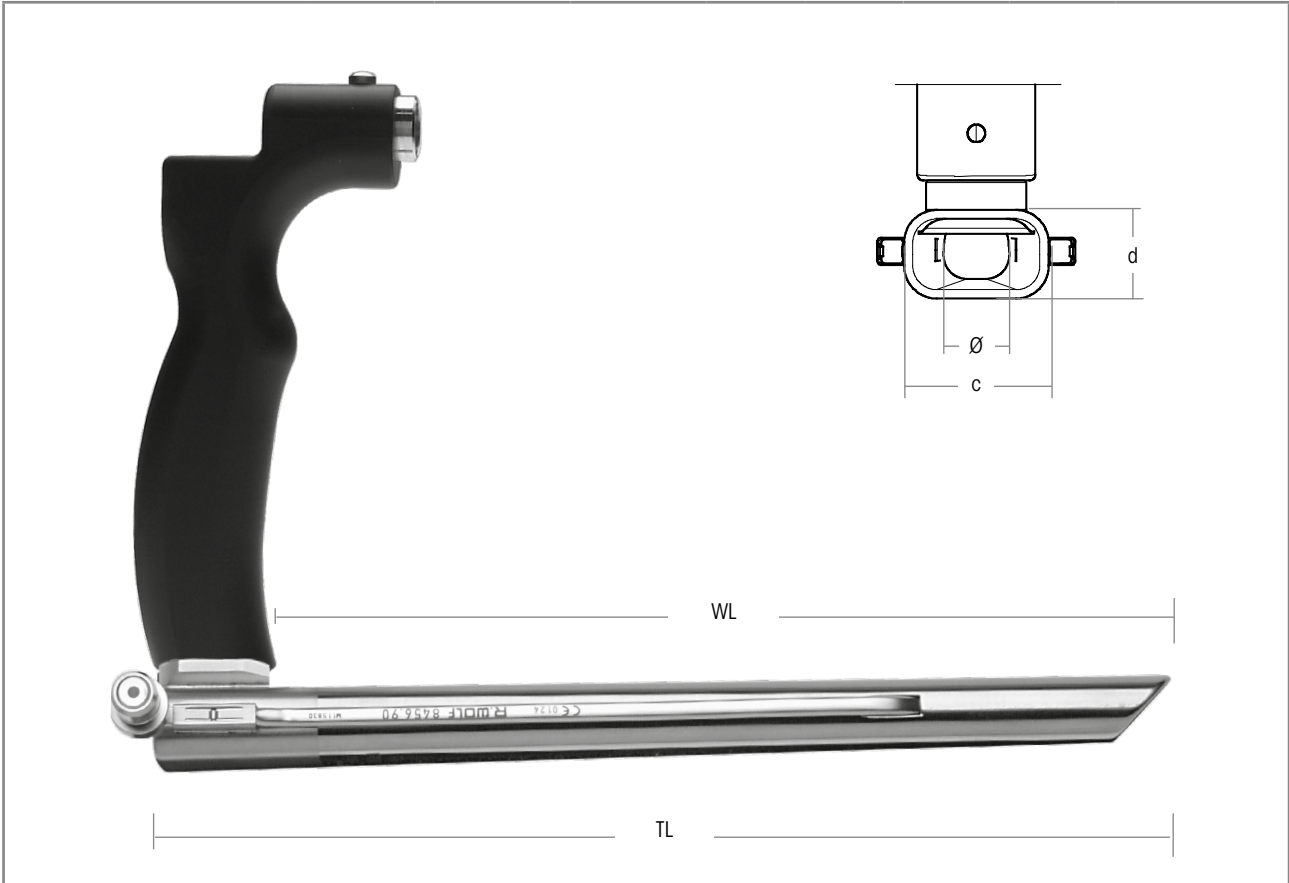

	Operating laryngoscope	Light rod for laryngoscope	Insufflation / suction tube	Inner dimensions		WL	TL	Product no.
				distally Ø	proximally c x d			
SubTlotoscope bndl consisting of: operating laryngoscope, light rod for laryngoscope, and insufflation / suction tube with universal handle for all support and holding systems	8456.101	8456.90	8456.95	12 mm	21.5 mm x 12 mm	175 mm	206 mm	8456.1011

Required:	Product no.
Chest support for operating laryngoscopes 	8449.911

V23 || Subject to modifications. Please note that some products may not be available in all countries. Please always take note of the information that is provided with the product. For more detailed information, please consult with your contact partner or directly with Richard Wolf GmbH.

OPERATING LARYNGOSCOPE FOR LASER PROCEDURES

LARYNGOSCOPES

1.3

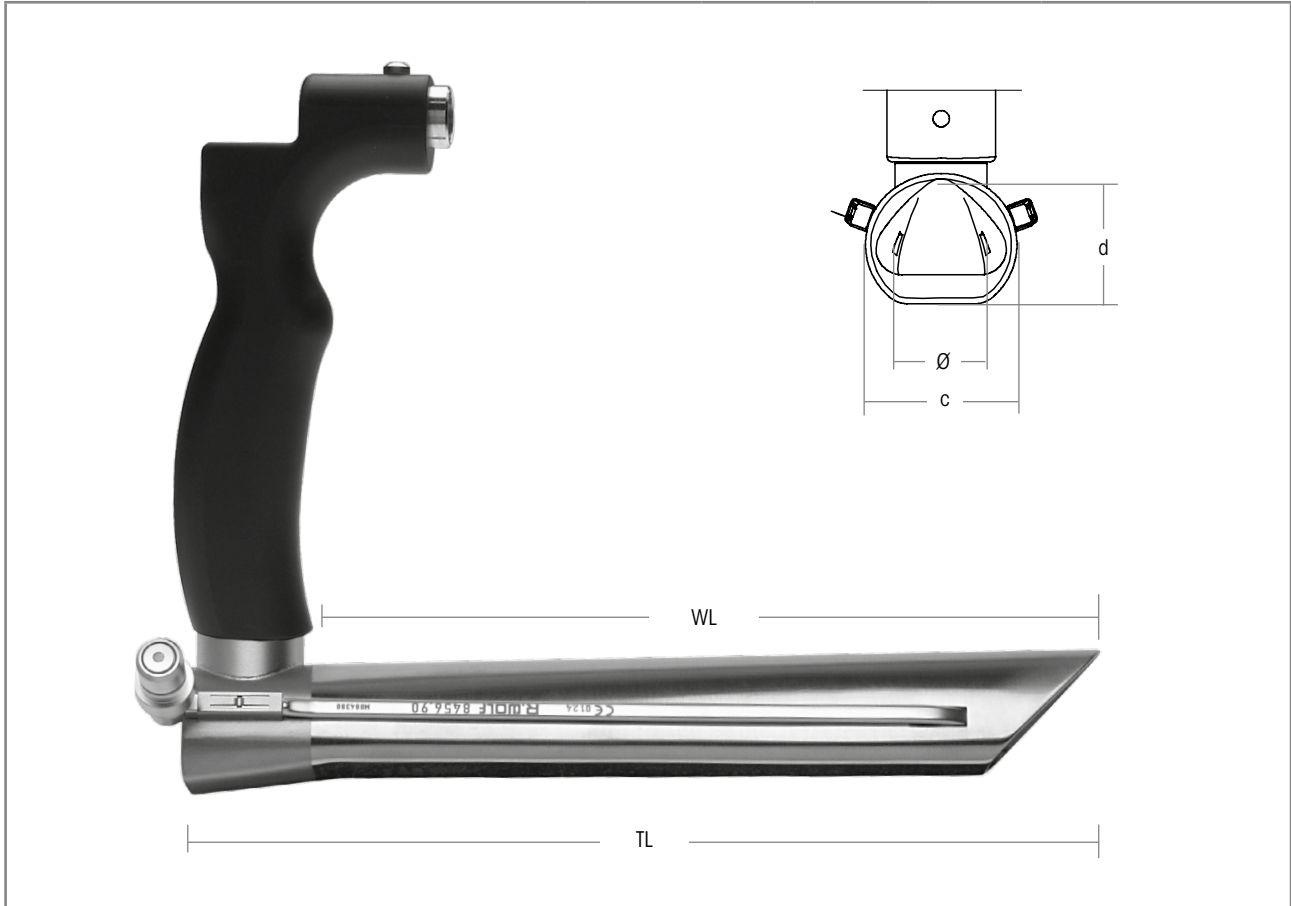

	Outer dimensions		WL	TL	Product no.
	distally Ø	proximally c x d			
Operating laryngoscope WL 153 mm with universal handle for all support and holding systems	14 mm	26 mm x 22 mm	153 mm	184 mm	8458.011

Required:	Product no.
External	
Light rod for laryngoscope	8456.90
Insufflation / suction tube TL 158 mm	8456.95
Chest support for operating laryngoscopes 	8449.911

V23 || Subject to modifications. Please note that some products may not be available in all countries. Please always take note of the information that is provided with the product. For more detailed information, please consult with your contact partner or directly with Richard Wolf GmbH.

LARYNGOSCOPE

FROM STEINER

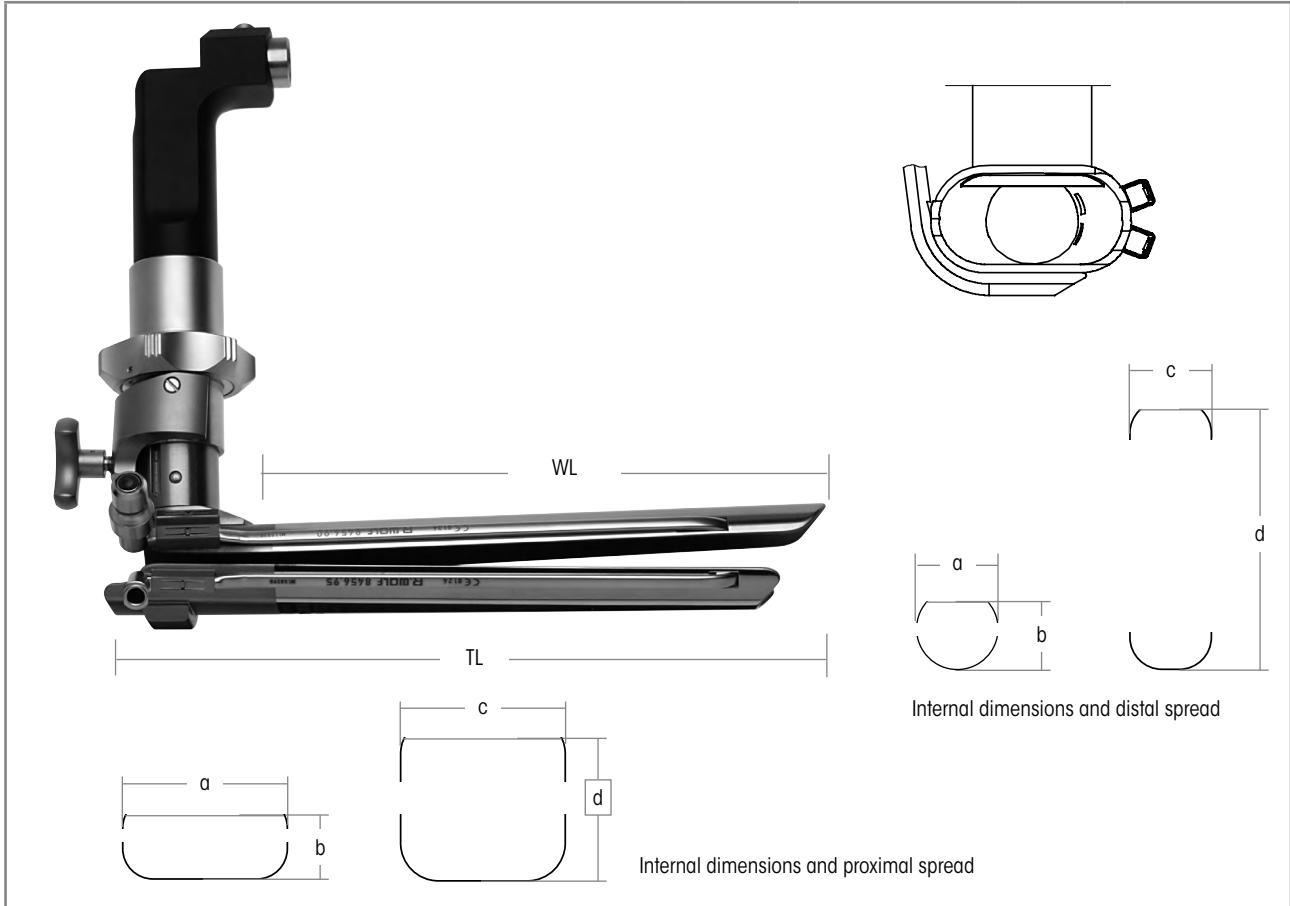

	Operating laryngoscope	Light rod for laryngoscope	Insufflation / suction tube	Internal dimensions and spread		WL	TL	Product no.
				proximally a x b c x d	distally a x b c x d			
Laryngoscope bndl consisting of: operating laryngoscope, light rod for laryngoscope, and insufflation / suction tube with universal handle for all support and holding systems	8456.01	8456.90	8456.95	(a x b) 32 x 12,5 mm	(a x b) 16 x 13,5 mm	148 mm	200 mm	8456.011
				(c x d) 32 x 27,5 mm	(c x d) 16 x 53 mm			

The light rod as well as the insufflation and suction tube can be adapted on either the right or the left side.

Required:	Product no.
Chest support for operating laryngoscopes 	8449.911

LARYNGOSCOPE

FROM POTOTSCHNIG

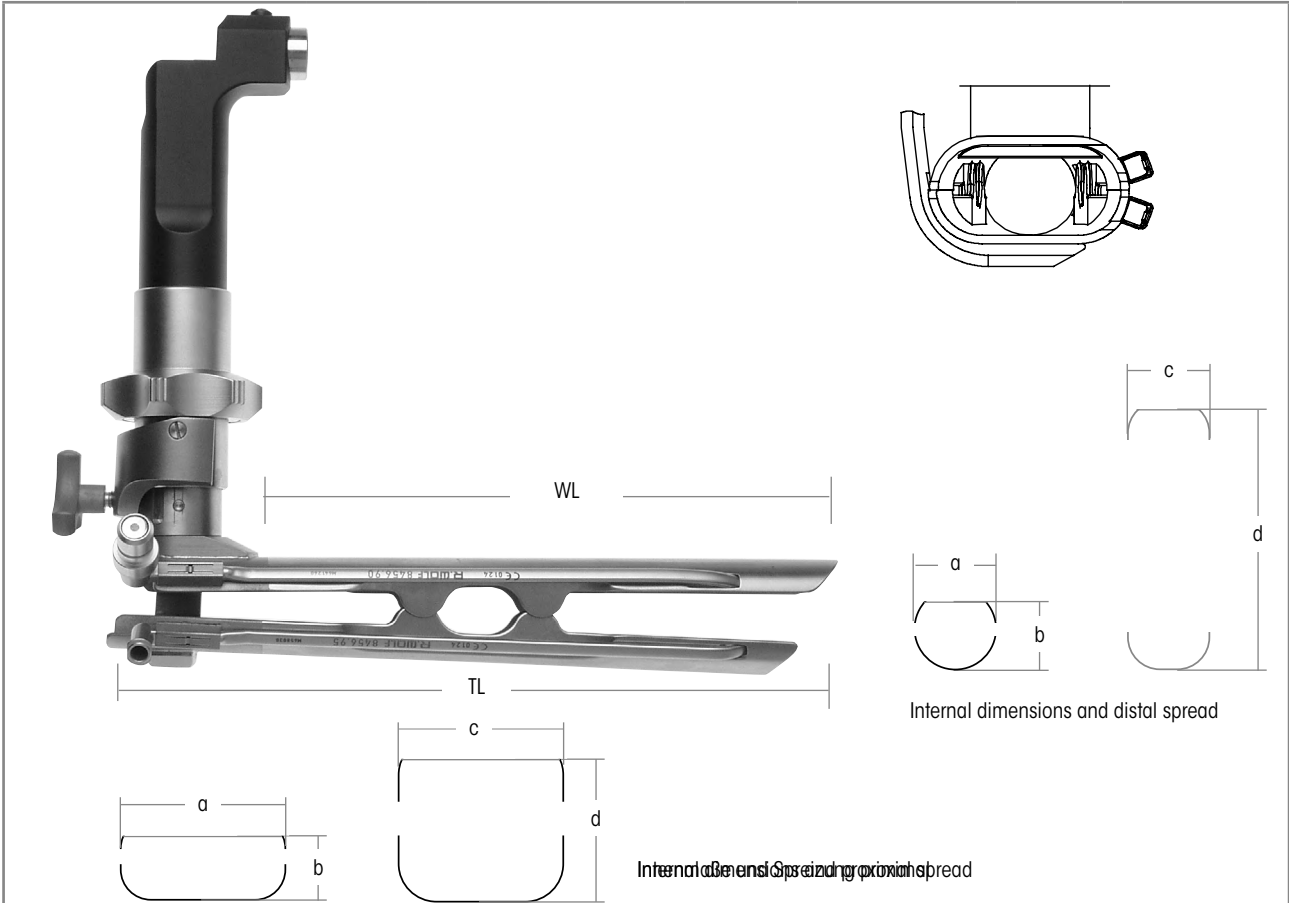

	Operating laryngoscope	Light rod for laryngoscope	Insufflation / suction tube	Internal dimensions and spread		WL	TL	Product no.
				proximally a x b c x d	distally a x b c x d			
Laryngoscope bndl consisting of: operating laryngoscope, light rod for laryngoscope, and insufflation / suction tube Straight spatula, with protection against soft tissue contusions, external light rod, and insufflation / suction tube, with universal handle for all support and holding systems	8457.011	8456.90	8456.95	(a x b) 32 x 12,5 mm	(a x b) 16 x 13,5 mm	148 mm	200 mm	8457.0111
				(c x d) 32 x 27,5 mm	(c x d) 16 x 53 mm			

The light rod as well as the insufflation and suction tube can be adapted on either the right or the left side.

Required:	Product no.
Chest support for operating laryngoscopes	 8449.911

OPERATING LARYNGOSCOPE

FROM POTOTSCHNIG-REMACLE

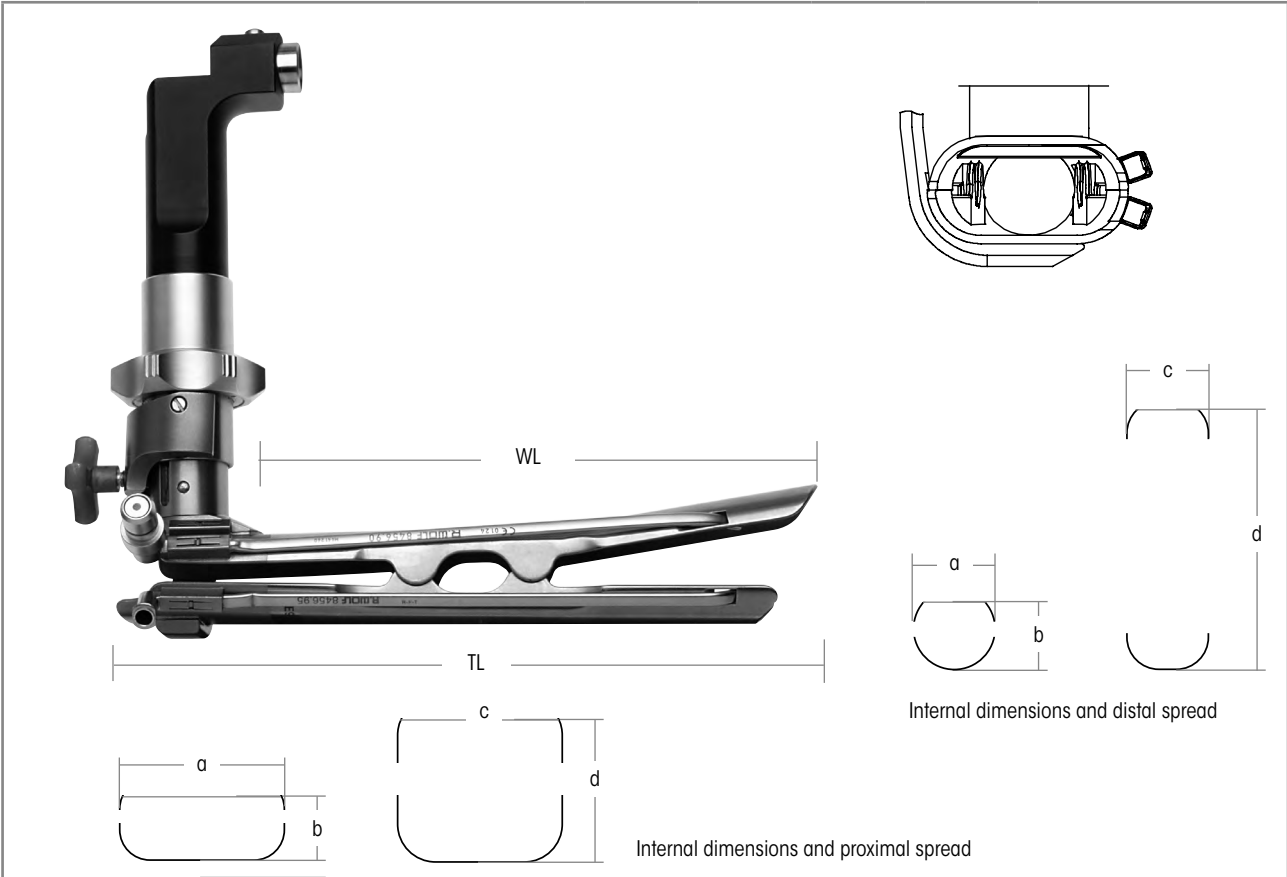

	Innenmaße und Spreizung		WL	TL	Artikel-Nr.
	proximal a x b c x d	distal a x b c x d			
OP-Laryngoskop WL 147 mm distal aufgebogener Spatel, mit Schutz vor Weichteilquetschungen, AußeWLIgender Lichtleitstab und Insufflations-Absaugrohr, mit Universal-Handgriff für alle Stütz-und Haltesysteme	(a x b) 32 x 12,5 mm	(a x b) 16 x 13,5 mm	147 mm	200 mm	82420.0000
	(c x d) 32 x 27,5 mm	(c x d) 16 x 73 mm			

Lichtleitstab sowie Insufflations- und Absaugrohr können wahlweise rechts oder links adaptiert werden.

Required:	Product no.
External	
Light rod for laryngoscope	8456.90
Insufflation / suction tube TL 158 mm	8456.95
Chest support for operating laryngoscopes 	8449.911

CHEST SUPPORT FOR OPERATING LARYNGOSCOPES

LARYNGOSCOPES
1.3







AUTOCLAVE
134° C / 273° F

Integrated smoke evacuation	Product no.
Chest support for operating laryngoscopes	8449.911

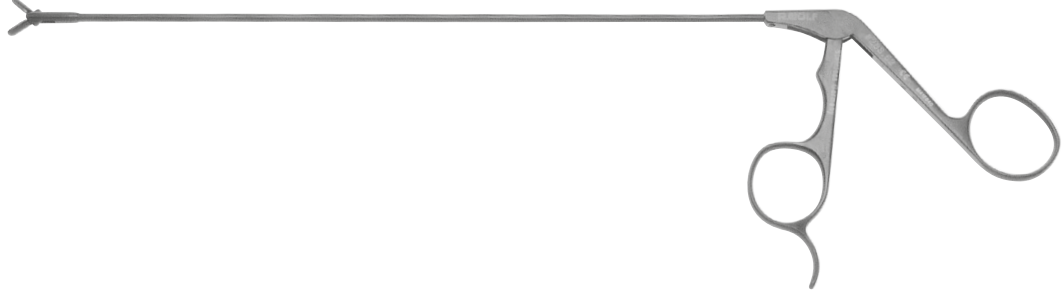
V23 || Subject to modifications. Please note that some products may not be available in all countries. Please always take note of the information that is provided with the product. For more detailed information, please consult with your contact partner or directly with Richard Wolf GmbH.

FORCEPS 3 MM FOR TUMOR SURGERY











		Ø	WL	Product no.
 rippled	Grasping forceps, small WL 230 mm	3.0 mm	230 mm	8283.51
 rippled	Grasping forceps, medium WL 245 mm	3.0 mm	245 mm	8283.52
 rippled	Grasping forceps, large WL 240 mm	3.0 mm	240 mm	8283.53

PROBE / KNOT PUSHER / KNIFE

PROBE / KNOT PUSHER / KNIFE

1.6

		Jaw insert	TL	Product no.
				
	Probe, blunt TL 265 mm	angled	265 mm	8267.21
	Knot pusher TL 280 mm		280 mm	8267.35
	Knife TL 262 mm	straight, crosswise oval	262 mm	8267.14
	Knife TL 262 mm	angled 45°, crosswise oval		8267.15
	Sickle knife TL 262 mm	curved		8267.10
	Knife TL 265 mm	round, with vertical cutting edge	265 mm	8267.12
Required:				
Handle				82460.0000

V23 || Subject to modifications. Please note that some products may not be available in all countries. Please always take note of the information that is provided with the product. For more detailed information, please consult with your contact partner or directly with Richard Wolf GmbH.

SUCTION TUBE



Bipolar		Ø	WL	Product no.
	Suction tube, bipo Ø 3.2 mm WL 240 mm	3.2 mm	240 mm	8289.24

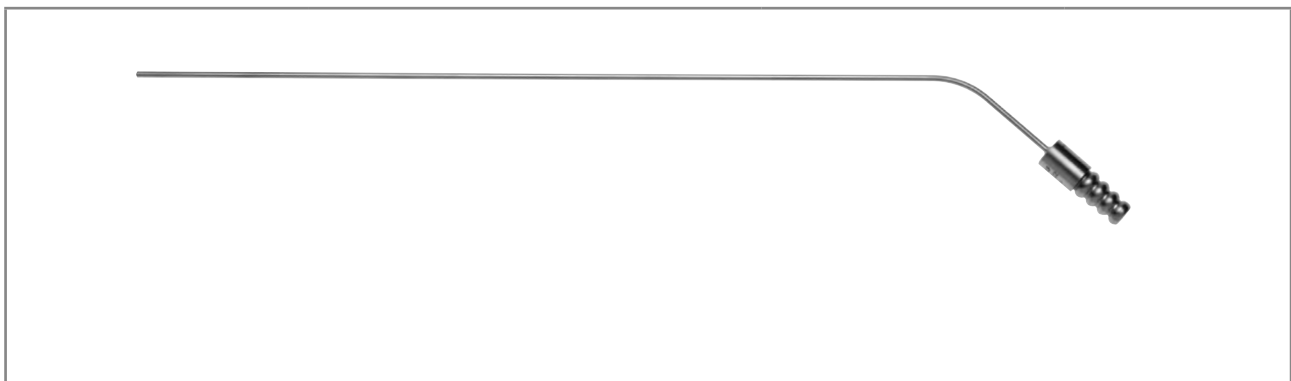

		Ø	WL	Product no.
	Suction tube OD 2 mm WL 250 mm	2.0 mm	250 mm	8291.22
	Suction tube OD 2.5 mm WL 250 mm	2.5 mm		8291.23
	Suction tube OD 3 mm WL 250 mm	3.0 mm		8291.24



Bipolar connection cable and HF connection cable: see page LARYNX26-29

HF COAGULATING SUCTION TUBE

SUCTION TUBES

1.7



		Ø	WL	Product no.
	HF coagulation suction tube OD 5.2 mm WL 240 mm	5.2 mm	240 mm	84420.2105
	HF coagulation suction tube OD 5.2 mm WL 240 mm angled			84420.2107

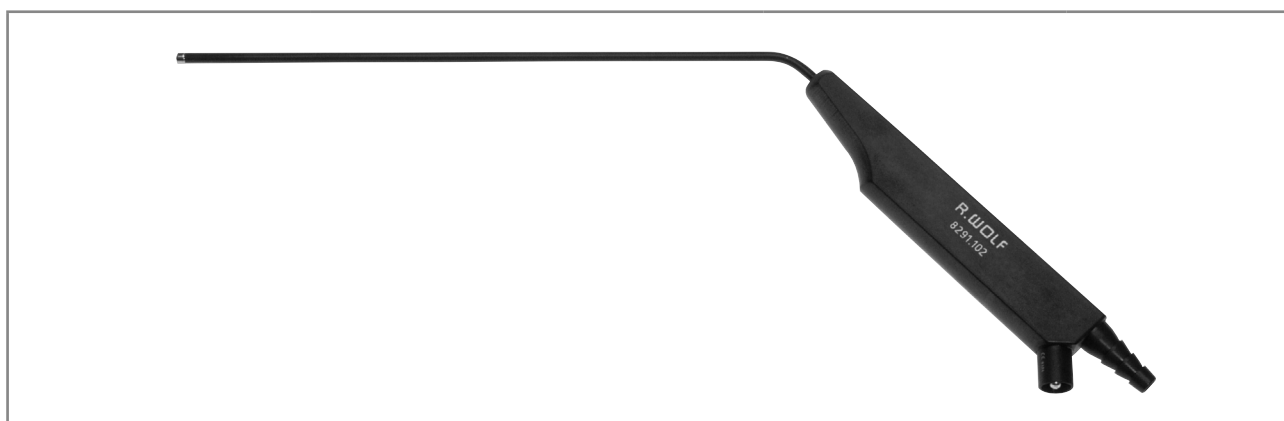

monopolar		Ø	WL	Product no.
	HF coagulation suction tube OD 3.1 mm WL 210 mm	3.1 mm	210 mm	8291.101
	HF coagulation suction tube OD 4.1 mm WL 210 mm	4.1 mm		8291.102

Bipolar connection cable and HF connection cable: see page LARYNX26-29

NEEDLE CARRIER INSTRUMENT







FOR THE FIXATION OF VOCAL CORD PROSTHESES OR VOCAL CORD LATERAL FIXATION

by Lichtenberger



		WL	Product no.
	Needle carrier instrument WL 210 mm	210 mm	8267.50
Required:			
For needle carrier instrument 8267.50	Spare needles Ø 0.64 mm, TL 37 mm (PU = 100 PCS)		8267.951

HF CONNECTION CABLE MONO 815xxx

Instrument connector	Device connector		Product no.
<p>WOLF Resectoscopes</p> 		<p>HF connection cable mono L 3 m</p>	<p>815.032</p>
	<p>ERBE (ACC/ICC/IO)/BOWA (EU) R. Wolf HF surgical generator 400 kHz 2260002</p>	<p>HF connection cable mono L 5 m</p>	<p>815.052</p>
		<p>HF connection cable mono L 3 m</p>	<p>815.132</p>
	<p>ERBE (T series)</p>	<p>HF connection cable mono L 5 m</p>	<p>815.152</p>
<p>HF electrodes, monopolar</p> 		<p>HF connection cable mono L 3 m</p>	<p>815.031</p>
	<p>Martin (M-version)/Berchtold/ Aesculap</p>	<p>HF connection cable mono L 5 m</p>	<p>815.051</p>
		<p>HF connection cable mono L 3 m</p>	<p>815.033</p>
<p>HF electrodes, monopolar</p>	<p>Bovie/Valleylab/Erbe (Int.)/ BOWA (Int.) R. Wolf HF surgical generator 400 kHz 2260001</p>	<p>HF connection cable mono L 5 m</p>	<p>815.053</p>
		<p>HF connection cable mono L 3 m</p>	<p>815.034</p>
<p>HF electrodes, monopolar</p>	<p>BOWA (Int./EU) Eschmann and other devices with 4 mm plugs R. Wolf HF surgical generator 400 kHz 2260001</p>	<p>HF connection cable mono L 5 m</p>	<p>815.054</p>

V23 | Subject to modifications. Please note that some products may not be available in all countries. Please always take note of the information that is provided with the product. For more detailed information, please consult with your contact partner or directly with Richard Wolf GmbH.

HF CONNECTION CABLE MONO 8106xxx









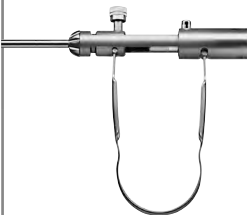

Instrument connector	Device connector		Product no.
<p>WOLF Instruments/surgical generator</p> 		<p>HF connection cable mono L 3 m</p>	<p>8106.032</p>
	<p>ERBE (ACC/ICC/IO)/BOWA (EU) R. Wolf HF surgical generator 400 kHz 2260002</p>	<p>HF connection cable mono L 5 m</p>	<p>8106.052</p>
		<p>HF connection cable mono L 3 m</p>	<p>8106.132</p>
	<p>ERBE (T series)</p>	<p>HF connection cable mono L 5 m</p>	<p>8106.152</p>
		<p>HF connection cable mono L 3 m</p>	<p>8106.031</p>
<p>HF electrodes, monopolar</p> 	<p>Martin (M-version)/Berchtold/ Aesculap</p>	<p>HF connection cable mono L 5 m</p>	<p>8106.051</p>
		<p>HF connection cable mono L 3 m</p>	<p>8106.033</p>
	<p>Bovie/Valleylab/Erbe (Int.)/ BOWA (Int.) R. Wolf HF surgical generator 400 kHz 2260001</p>	<p>HF connection cable mono L 5 m</p>	<p>8106.053</p>
	<p>BOWA (Int./EU) Eschmann and other devices with 4 mm plugs R. Wolf HF surgical generator 400 kHz 2260001/2260002</p>	<p>HF connection cable mono L 3 m</p>	<p>8106.034</p>
	<p>Eschmann and other devices with 4 mm plugs R. Wolf HF surgical generator 400 kHz 2260001/2260002</p>	<p>HF connection cable mono L 5 m</p>	<p>8106.054</p>

BIPO HF CONNECTION CABLE

8108xxx





ACCESSORIES

1.9

Instrument connector	Device connector		Product no.
 <p>WOLF Bipolar forceps</p>	 <p>ERBE (ACC/ICC/T)/BOWA (EU) R. Wolf HF surgical generator 400 kHz 2260001/2260002</p>	HF connection cable bipo; L 3 m	8108.032
		HF connection cable bipo; L 5 m	8108.052
	 <p>International / 2-pin Valleylab R. Wolf HF surgical generator 400 kHz 2260001/2260002</p>	HF connection cable bipo; L 3 m	8108.033
		HF connection cable bipo; L 5 m	8108.053
	 <p>WOLF/Martin (M-version)/ Berchtold/Aesculap</p>	HF connection cable bipo; L 3 m	8108.031
		HF connection cable bipo; L 5 m	8108.051
	 <p>EMC Dolley</p>	HF connection cable bipo; L 3 m	8108035
	 <p>Bipolar tweezers connection</p>	 <p>ERBE (ACC/ICC/T)/BOWA (EU) R. Wolf HF surgical generator 400 kHz 2260001/2260002</p>	HF connection cable bipo; L 3 m
HF connection cable bipo; L 5 m			8108.152
 <p>International / 2-pin Valleylab R. Wolf HF surgical generator 400 kHz 2260001/2260002</p>		HF connection cable bipo; L 3 m	8108.133
		HF connection cable bipo; L 5 m	8108.153
 <p>Martin (M-version)/Berchtold/ Aesculap</p>		HF connection cable bipo; L 3 m	8108.131
		HF connection cable bipo; L 5 m	8108.151
 <p>EMC Dolley</p>		HF connection cable bipo; L 3 m	8108135

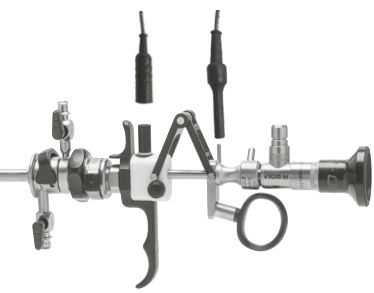
V23 || Subject to modifications. Please note that some products may not be available in all countries. Please always take note of the information that is provided with the product. For more detailed information, please consult with your contact partner or directly with Richard Wolf GmbH.

HF CONNECTION CABLE BIPO FOR RESECTION IN SALINE SOLUTION

Instrument connector	Device connector		Product no.	
<p>WOLF S(a)line resectoscopes</p> 	 Erbe VIO 300D	<p>Bipolar cable; TUR/TCR; WOLF</p> <p>MF plug; L 4 m</p>	<p>20196-119</p>	
	 Erbe VIO 3	<p>BIPOLAR CABLE; MF-U</p> <p>MF plug; L 4.5 m</p>	<p>21196-119</p>	
	 KLS Martin	<p>HF connection cable bipo; L 3 m</p>	<p>8108.231</p>	
		<p>HF connection cable bipo; L 5 m</p>	<p>8108.251</p>	
	 R. Wolf HF surgical generator 400 kHz 2260001/2260002		<p>HF connection cable bipo; L 3 m</p>	<p>8108233</p>
			<p>HF connection cable bipo; L 5 m</p>	<p>8108253</p>

