

GYNECOLOGY

GYNECOLOGY

1

GYNECOLOGICAL LAPAROSCOPY

2

HYSTEROSCOPY

3

INTERDISCIPLINARY APPLICATIONS



**GYNECOLOGICAL
LAPAROSCOPY**

GYNECOLOGICAL LAPAROSCOPY

1

BASIC SETS

2

SecuFIX UTERUS MANIPULATOR

3

TELESCOPES

4

TROCAR SLEEVES/DILATION/EXTRACTION/REDUCING SLEEVES

5

ERAGONMODULAR GRASPING FORCEPS/DISSECTORS/BIOPSY FORCEPS/SCISSORS

6

BIPOLAR FORCEPS

7

ERAGONBIPOLAR FORCEPS AND SCISSORS

8

HF ELECTRODES (MONOPOLAR/BIPOLAR)

9

MULTIFUNCTIONAL SUCTION IRRIGATION SYSTEM

10

TISSUE RETRACTOR

11

CLIP APPLICATOR

12

NEEDLE HOLDER/KNOT PUSHER/FASCIA CLOSURE

13

CANNULAS/SURGICAL PROBES/MYOMA DRILLS

14

INSUFFLATORS

15

FLUID CONTROL

16

HF GENERATOR

17

ACCESSORIES

18

TRAINING MODELS

BASIC SET

FOR ALL LAPAROSCOPIC PROCEDURES

Product	Product no.	Quantity	Catalog / Section
Insufflator 45 EVAC + HEAT bndl	22350312	1	Gynecology / 14
VERES cannula Ø 2.1 mm WL 120 mm	8302.12	1	Gynecology / 4
LAP suction irrigation pump bndl	22160011	1	Gynecology / 15
LED light source ENDOLIGHT LED 2.1 bndl	51630011	1	Imaging / Light sources
Fiber light cable		1	Imaging / Light cables
ENDOCAM Logic 4K	5525	1	Imaging / ENDOCAM
Monitors		1	Imaging / Monitors
Device cart		1	Imaging / Device cart

BASIC SET

FOR LAPAROSCOPIC CYST EXSTIRPATION

Product	Product no.	Quantity	Catalog / Section
Telescope 0° Ø 10 mm WL 307 mm	8934.431	1	Gynecology / 3
and/or			
Telescope 30° Ø 10 mm WL 307 mm	8934.432	1	Gynecology / 3
Fiber light cable bndl	806650231	1	Gynecology / 3
Trocar sleeve, slanted, capacity 5.5 mm WL 100 mm	8921.013	2-3	Gynecology / 4
and/or			
Trocar sleeve, straight, capacity 5.5 mm WL 102 mm	8919.351	2-3	Gynecology / 4
Trocar sleeve, slanted, capacity 10 mm WL 100 mm	8923.013	2	Gynecology / 4
Guide rod 5.5 mm TL 500 mm	8923.921	1	Gynecology / 4
Instrument sleeve 10 mm WL 170 mm	8385.50	1	Gynecology / 4
VERES cannula Ø 2.1 mm WL 120 mm	8302.12	1	Gynecology / 4
Multifunctional suction irrigation system			
Suction irrigation tube Ø 5 mm WL 310 mm	8383.911	1	Gynecology / 9
Suction irrigation handle	8385.901	1	Gynecology / 9
Sealing cap	8385.902	1	Gynecology / 9
ERAGONmodular			
Atraumatic grasping forceps Ø 5 mm bndl	83932925	1	Gynecology / 5
Atraumatic grasping forceps mono Ø 5 mm bndl	83931817	2	Gynecology / 5
Maryland dissector forceps mono Ø 5 mm bndl	83932817	1	Gynecology / 5
Metzenbaum scissors Ø 5 mm bndl	83930417	1	Gynecology / 5
Grasping forceps Ø 10 mm bndl	83952048	1	Gynecology / 5
Plate-shaped grasping forceps Ø 10 mm bndl	83952347	1	Gynecology / 5
ERAGONbipolar			
Grasping forceps bipo Ø 5.5 mm bndl	839300312	1	Gynecology / 7
ERAGONunipolar			
Hook electrode mono Ø 5 mm WL 340 mm	8383.423	1	Gynecology / 8
Needle forceps Ø 2.45 mm WL 160 mm	8756.201	1	Gynecology / 12
Sealing cone Ø 12-15 mm	8943.915	1	Gynecology / 12
Monopolar HF cable	8106	1	Gynecology / 17
Bipolar HF cable	8108	1	Gynecology / 17

BASIC SET FOR LAPAROSCOPIC CYST EXSTIRPATION

Product	Product no.	Quantity	Catalog / Section
Also on request:			
Telescope 0° Ø 5.3 mm WL 303 mm	8935441	1	Gynecology / 3
and/or			
Telescope 30° Ø 5.3 mm WL 303 mm	8935442	1	Gynecology / 3
Trocar sleeve, slanted, capacity 5.5 mm WL 100 mm	8921.013	1	Gynecology / 4
Trocar tip sharp size 5.5 mm WL 169 mm	8921.113	1	Gynecology / 4
ERAGONmodular			
Atraumatic grasping forceps mono Ø 5 mm bndl	83931957	1	Gynecology / 5
Biopsy forceps mono Ø 5 mm bndl	83930937	1	Gynecology / 5
Dissector forceps Ø 10 mm bndl	83952268	1	Gynecology / 5

BASIC SET

FOR LAPAROSCOPIC ADNEXECTOMY

Product	Product no.	Quantity	Catalog / Section
Telescope 0° Ø 10 mm WL 307 mm	8934.431	1	Gynecology / 3
and/or			
Telescope 30° Ø 10 mm WL 307 mm	8934.432	1	Gynecology / 3
Fiber light cable bndl	806650231	1	Gynecology / 3
Trocar sleeve, slanted, capacity 10 mm WL 100 mm	8923.013	2	Gynecology / 4
Trocar tip sharp size 10 mm	8923.113	2	Gynecology / 4
and/or			
Trocar sleeve, straight, capacity 5.5 mm WL 102 mm	8919.351	2-3	Gynecology / 4
Trocar tip sharp size 5.5 mm WL 144 mm	8919.3512	2-3	Gynecology / 4
Trocar sleeve, slanted, capacity 5.5 mm WL 100 mm	8921.013	2-3	Gynecology / 4
Trocar tip sharp size 5.5 mm WL 169 mm	8921.113	2-3	Gynecology / 4
Guide rod 5.5 mm TL 500 mm	8923.921	1	Gynecology / 4
Instrument sleeve 10 mm WL 170 mm	8385.50	1	Gynecology / 4
ERAGONmodular			
Grasping forceps mono Ø 5 mm bndl	83932877	1	Gynecology / 5
Atraumatic grasping forceps mono Ø 5 mm bndl	83931817	2	Gynecology / 5
Maryland dissector forceps mono Ø 5 mm bndl	83932817	1	Gynecology / 5
Metzenbaum scissors Ø 5 mm bndl	83930417	1	Gynecology / 5
Grasping and dissector forceps 5 mm	83932827	1	Gynecology / 5
ERAGONbipolar			
Grasping forceps bipo Ø 5.5 mm bndl	839300312	1	Gynecology / 7
Multifunctional suction irrigation system			
Suction irrigation tube Ø 5 mm WL 310 mm	83839.11	1	Gynecology / 9
Suction irrigation handle	8385.901	1	Gynecology / 9
Sealing cap	8385.902	1	Gynecology / 9
VERES			
VERES cannula Ø 2.1 mm WL 120 mm	8302.12	1	Gynecology / 4
Bipolar HF cable	8108	1	Gynecology / 17
Monopolar HF cable	8106	1	Gynecology / 17

BASIC SET FOR LAPAROSCOPIC ADNEXECTOMY

Product	Product no.	Quantity	Catalog / Section
Also on request:			
ENDOCAM Logic 4K	5525	1	Imaging / ENDOCAM
ERAGONmodular			
Dissector forceps mono Ø 5 mm bndl	83932897	1	Gynecology / 5
Grasping forceps mono Ø 5 mm bndl	83931837	2	Gynecology / 5
Biopsy forceps mono Ø 5 mm bndl	83930917	1	Gynecology / 5
Maryland dissector forceps Ø 10 mm bndl	83952257	1	Gynecology / 5
Needle holder Ø 5 mm bndl	8393.502	1	Gynecology / 12

BASIS-SET

FOR HYSTERECTOMY

Product	Product no.	Quantity	Catalog / Section
Telescope 0° Ø 10 mm WL 307 mm	8934.431	1	Gynecology / 3
and/or			
Telescope 30° Ø 10 mm WL 307 mm	8934.432	1	Gynecology / 3
Fiber light cable bndl	806650231	1	Gynecology / 3
Trocar sleeve, slanted, capacity 10 mm WL 100 mm	8923.013	2	Gynecology / 4
Trocar tip sharp size 10 mm	8923.113	2	Gynecology / 4
and/or			
Trocar sleeve, straight, capacity 5.5 mm WL 102 mm	8919.351	2-3	Gynecology / 4
Trocar tip sharp size 5.5 mm WL 144 mm	8919.3512	2-3	Gynecology / 4
Trocar sleeve, slanted, capacity 5.5 mm WL 100 mm	8921.013	2-3	Gynecology / 4
Trocar tip sharp size 5.5 mm WL 169 mm	8921.113	2-3	Gynecology / 4
Guide rod 5.5 mm TL 500 mm	8923.921	1	Gynecology / 4
Instrument sleeve 10 mm WL 170 mm	8385.50	1	Gynecology / 4
ERAGONmodular			
Grasping forceps mono Ø 5 mm bndl	83932877	1	Gynecology / 5
Atraumatic grasping forceps mono Ø 5 mm bndl	83931817	2	Gynecology / 5
Maryland dissector forceps mono Ø 5 mm bndl	83932817	1	Gynecology / 5
Metzenbaum scissors Ø 5 mm bndl	83930417	1	Gynecology / 5
Grasping and dissector forceps 5 mm	83932827	1	Gynecology / 5
ERAGONbipolar			
Grasping forceps bipo Ø 5.5 mm bndl	839300312	1	Gynecology / 7
Multifunctional suction irrigation system			
Suction irrigation tube Ø 5 mm WL 310 mm	83839.11	1	Gynecology / 9
Suction irrigation handle	8385.901	1	Gynecology / 9
Sealing cap	8385.902	1	Gynecology / 9
VERES			
VERES cannula Ø 2.1 mm WL 120 mm	8302.12	1	Gynecology / 4
Bipolar HF cable	8108	1	Gynecology / 17
Monopolar HF cable	8106	1	Gynecology / 17

BASIS-SET FOR HYSTERECTOMY



Product	Product no.	Quantity	Catalog / Section
Uterus manipulator			
SecuFIX Uterus manipulator Ø 36 mm	8370701	1	Gynecology / 2
SecuFIX Uterus probe Ø 5 mm	8370702	1	Gynecology / 2
Cleaning brush Ø 5 mm TL 700 mm	7970705	1	Gynecology / 2
Cleaning brush Ø 9 mm TL 400 mm	7970409	1	Gynecology / 2
Sealing cap capacity 3.4–5.1 mm	89.02	1	Gynecology / 2
SecuFIX Colpotransilluminator vacuum tube (PACK=10 PCS)	41708370	1	Gynecology / 2
Accessories			
Irrigation tube L 0.6 m	163915	1	Gynecology / 2
Fiber light cable bndl	806635231	1	Gynecology / 2
RiWO System Tray	33024	1	Gynecology / 2
Also on request:			
ENDOCAM Logic 4K	5525	1	Imaging / ENDOCAM
ERAGONmodular			
Dissector forceps mono Ø 5 mm bndl	83932897	1	Gynecology / 5
Grasping forceps mono Ø 5 mm bndl	83931837	2	Gynecology / 5
Biopsy forceps mono Ø 5 mm bndl	83930917	1	Gynecology / 5
Maryland dissector forceps Ø 10 mm bndl	83952257	1	Gynecology / 5
Clip applicator Ø 10 mm WL 340 mm	8389.911	1	Gynecology / 11
Ethicon® Ligaclips® (PACK= 108 PCS)	8389.915	1	Gynecology / 11
Introduction sleeve 10 mm WL 80 mm	8389.991	1	Gynecology / 11
Needle holder Ø 5 mm bndl	8393.502	1	Gynecology / 12

SecuFIX UTERUS MANIPULATOR

SYSTEM WITH COLPOTRANSILLUMINATION AND VACUUM FIXATION



		Product no.
SecuFIX Uterus manipulator Ø 36 mm		8370701
SecuFIX Uterus probe Ø 5 mm	with longitudinal scale	8370702
Cleaning brush Ø 5 mm TL 700 mm		7970705
Cleaning brush Ø 9 mm TL 400 mm		7970409
Sealing cap capacity 3.4–5.1 mm	(PACK = 10 PCS)	89.02
SecuFIX Colpotransilluminator vacuum tube	Set contains: Colpotransilluminator and vacuum tube (with check valve, suction connection, Y connection part for use with a suction instrument on the same suction device, suction clamp), disposable (PACK= 10 PCS, in individual sterile packaging)	41708370

Accessories		Product no.
Irrigation tube L 0.6 m 		163915
Fiber light cable bndl 	Fiber bundle, Ø 3.5 mm (color marking orange), length 2.3 m	806635231
RIWO System Tray 	Container (W x H x D) 500 x 60 x 200 mm with instrument mat Internal dimensions (W x H x D): 500 x 57 x 200 mm, External dimensions (W x H x D): 566 x 77 x 266 mm	33024

1124|| Subject to modifications. Please note that some products may not be available in all countries. Please always take note of the information that is provided with the product. For more detailed information, please consult with your contact partner or directly with Richard Wolf GmbH.

MINI FIBER TELESCOPES 2.0 MM

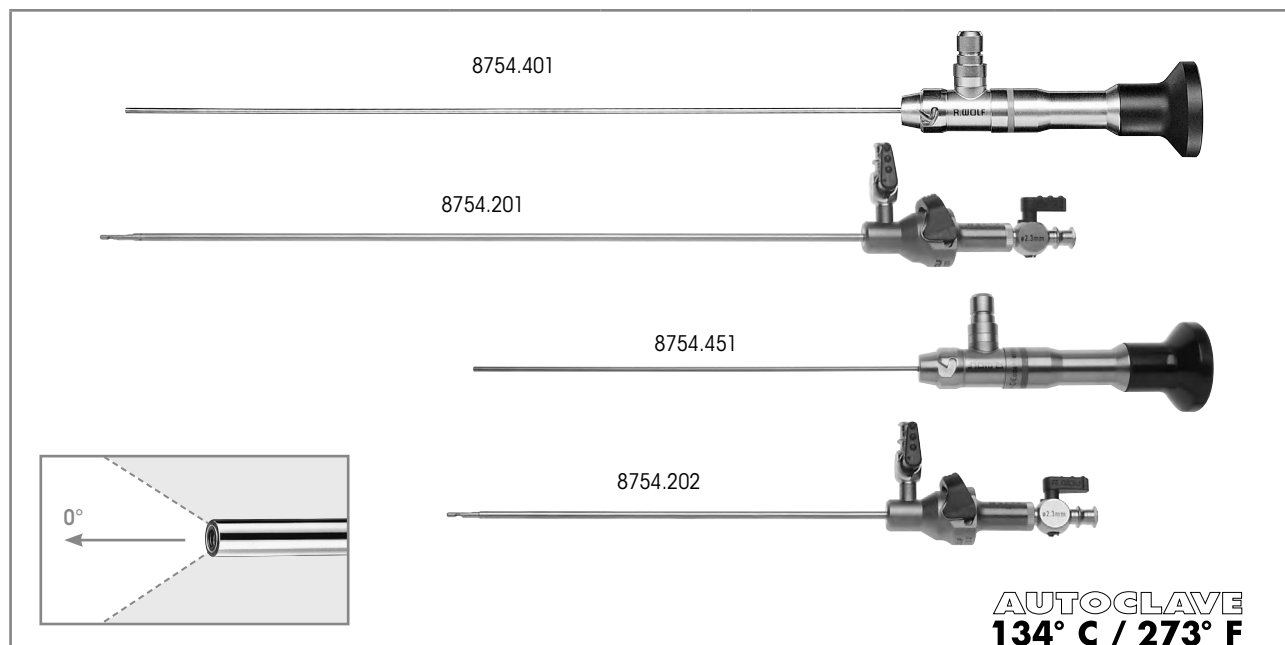

AUTOCLAVE
134° C / 273° F

Long version	Direction of view	WL	TL	Ø	Product no.
Telescope 0° Ø 2 mm NL 268 mm	0°	268 mm	365 mm	2.0 mm	8754.401
for this:					
VERES cannula Ø 2.3 mm WL 250 mm consisting of: 1x VERES cannula Ø 2.3 mm WL 274 mm (8754.211) 1x outer sheath Ø 2.8 mm, WL 250 mm (8754.221)		250 mm		2.3 mm	8754.201
Short version	Direction of view	WL	TL	Ø	Product no.
Telescope 0° Ø 2 mm NL 158 mm	0°	158 mm	255 mm	2.0 mm	8754.451
for this:					
VERES cannula Ø 2.3 mm WL 170 mm consisting of: 1x VERES cannula Ø 2.3 mm WL 164 mm (8754.212) 1x outer sheath Ø 2.8 mm WL 141 mm (8754.222)		170 mm		2.3 mm	8754.202
Recommended accessories					Product no.
Perforated basket for standard telescope 1 (for telescope 8754.451)		(W x H x D) 297 x 54 x 59 mm			38015
Perforated basket for standard telescope 2 (for telescope 8754.401)		(W x H x D) 481 x 54 x 59 mm			38016
Fiber light cable bndl consisting of: Fiber light cable (80662523), projector-side adapter (8095.07), and endoscope-side adapter (809509)		Ø 2.5 mm, 2.3 m long			806625231

112411 Subject to modifications. Please note that some products may not be available in all countries. Please always take note of the information that is provided with the product. For more detailed information, please consult with your contact partner or directly with Richard Wolf GmbH.

LAPAROSCOPES 3.5 MM

TELESCOPES

3

free of distortion

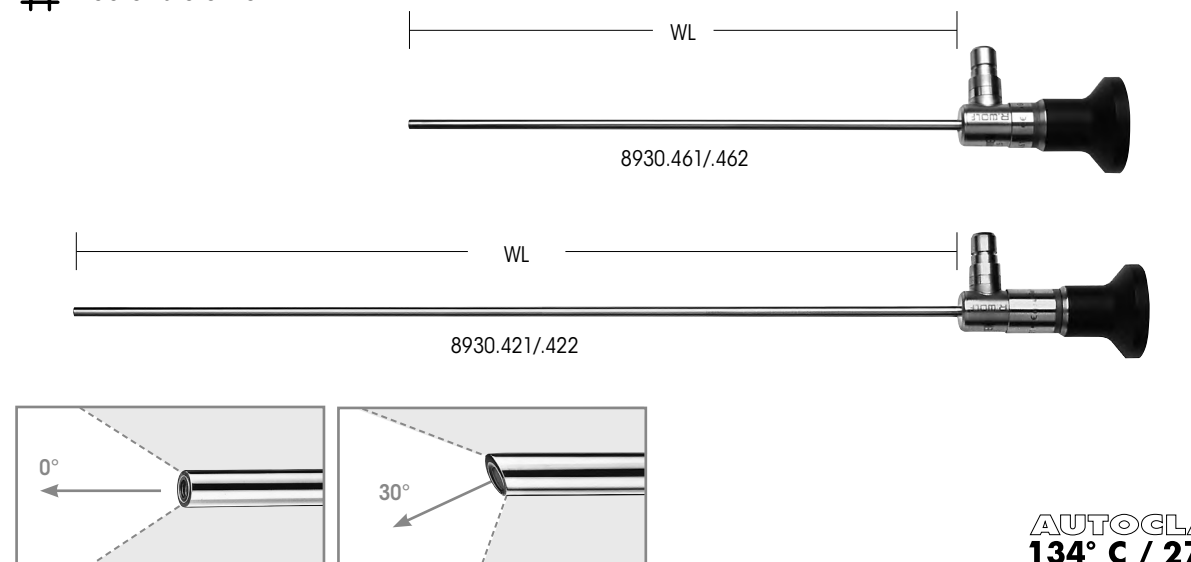

**AUTOCLAVE
134° C / 273° F**

	Direction of view	WL	TL	Ø	Product no.
PANOVIEW PLUS Telescope 0° 3.5 mm WL 180 mm	0°	180 mm	232 mm	3.5 mm	8930.461
PANOVIEW PLUS Telescope 30° 3.5 mm WL 180 mm	30°		233 mm		8930.462
PANOVIEW PLUS Telescope 0° Ø 3.5 mm WL 300 mm	0°	300 mm	361 mm		8930.421
PANOVIEW PLUS Telescope 30° 3.5 mm WL 300 mm	30°		362 mm		8930.422

Recommended accessories		Product no.
Perforated basket for standard telescope 1 (for telescope 8930.461/.462)	(W x H x D) 297 x 54 x 59 mm	38015
Perforated basket for standard telescope 2 (for telescope 8930.421/.422)	(W x H x D) 481 x 54 x 59 mm	38016
Fiber light cable bndl consisting of: Fiber light cable (80662523), projector-side adapter (8095.07), and endoscope-side adapter (809509)	Ø 2.5 mm, 2.3 m long	806625231

1124|| Subject to modifications. Please note that some products may not be available in all countries. Please always take note of the information that is provided with the product. For more detailed information, please consult with your contact partner or directly with Richard Wolf GmbH.

LAPAROSCOPES 5.3 MM

 free of distortion

full screen

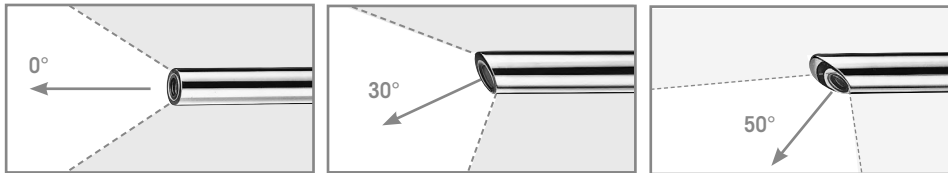
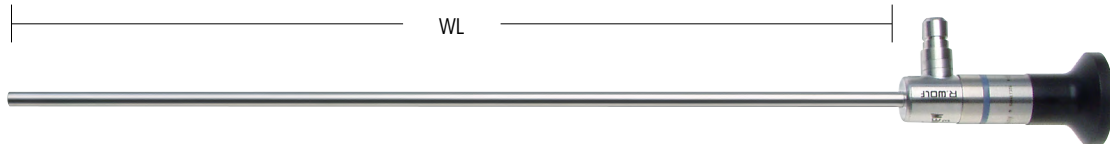

AUTOCLAVE
134° C / 273° F

	Direction of view	WL	TL	Ø	Product no.
PANOVIEW Telescope 0° Ø 5.3 mm WL 303 mm	0°	303 mm	372 mm	5.3 mm	8935.441
PANOVIEW Telescope 30° Ø 5.3 mm WL 303 mm	30°		373 mm		8935.442
PANOVIEW Telescope 50° Ø 5.3 mm WL 309 mm	50°	309 mm	377 mm		8935.443

Recommended accessories		Product no.
Perforated basket for standard telescope 2	(W x H x D) 481 x 54 x 59 mm	38016
Fiber light cable bndl consisting of: Fiber light cable (80662523), projector-side adapter (8095.07), and endoscope-side adapter (809509)	Ø 2.5 mm, 2.3 m long	806625231

112411 Subject to modifications. Please note that some products may not be available in all countries. Please always take note of the information that is provided with the product. For more detailed information, please consult with your contact partner or directly with Richard Wolf GmbH.

MINI OR LAPAROSCOPE 5.5 MM WITH 3.5 MM WORKING CHANNEL

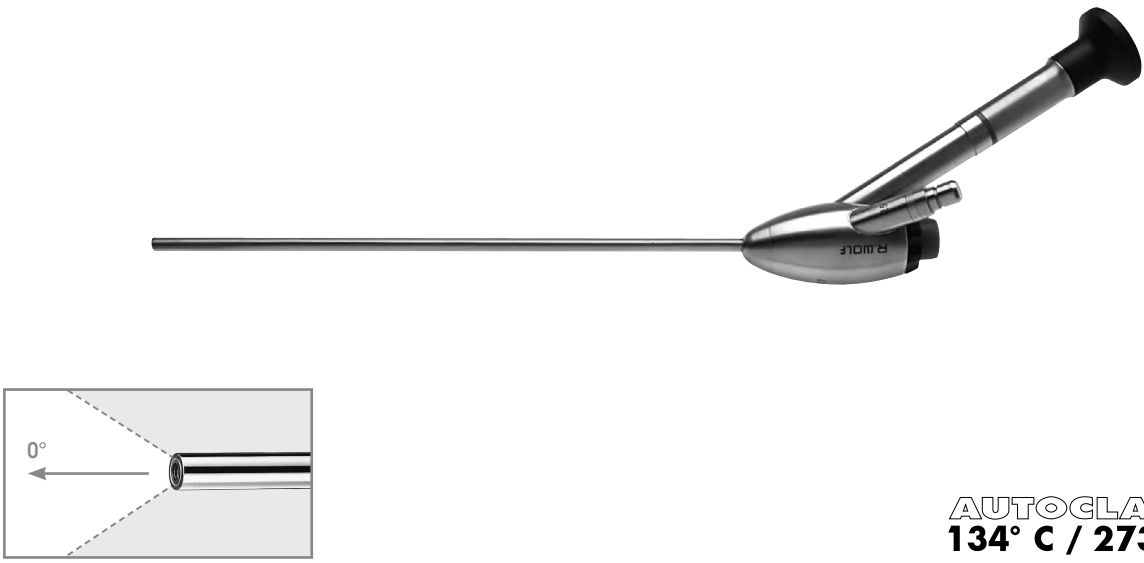

**AUTOCLAVE
134° C / 273° F**

	Direction of view	SL	TL	Ø	Working channel Ø	Product no.
OR endoscope bndl consisting of: OR endoscope 0° Ø 5.5 mm SL 215 mm (8920.401) Autom. sealing element ID 5.7 mm (8920.311) Sealing cap, red-orange (15176.020) Sealing membrane Ø 17 mm (PACK= 10 PCS) (89.103)	0°	215 mm	370 mm	5.5 mm	3.5 mm	8920.4011

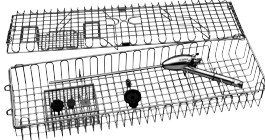
Recommended accessories		Product no.
Trocar sleeve, straight, capacity 5.5 mm WL 62 mm		8919.333
Trocar sleeve, straight, capacity 5.5 mm WL 102 mm		8919.353
Perforated basket for telescope Dimensions (W x L x H): 132 x 467 x 75 mm		38008
Fiber light cable bndl consisting of: Fiber light cable (80663523), projector-side adapter (8095.07), and endoscope-side adapter (809509)	Ø 3.5 mm, 2.3 m long	806635231

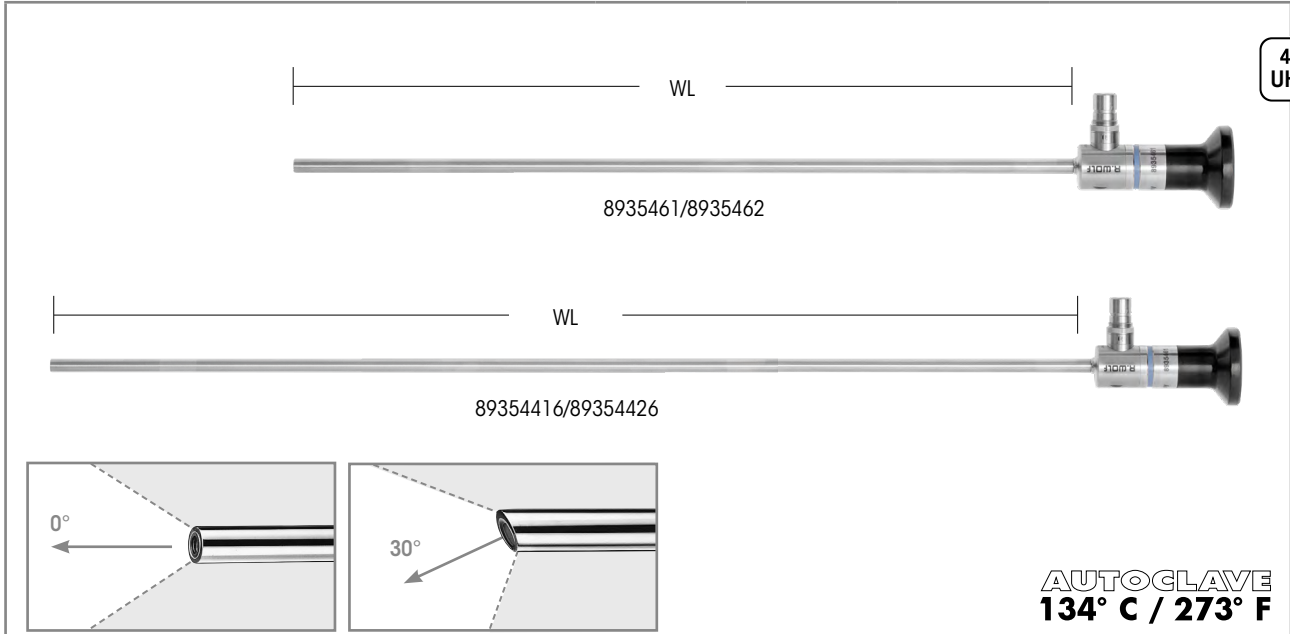

	Direction of view	WL	Ø	Product no.
PANOVIEW ULTRA Telescope Ø 5.5 mm WL 300 mm	0°	300 mm	5.5 mm	8935461
PANOVIEW ULTRA Telescope Ø 5.5 mm WL 300 mm	30°			8935462
PANOVIEW ULTRA Telescope Ø 5.5 mm WL 430 mm	0°	430 mm		89354416
PANOVIEW ULTRA Telescope Ø 5.5 mm WL 430 mm	30°			89354426

Recommended accessories		Product no.
Perforated basket for standard telescope 2 (for telescope 8935416/8935426)	(W x H x D) 481 x 54 x 59 mm	38016
Perforated basket for standard telescope 3 (for telescope 89354416/89354426)	(W x H x D) 619 x 54 x 59 mm	38017
Fiber light cable bndl consisting of: Fiber light cable (80663523), projector-side adapter (8095.07), and endoscope-side adapter (809509)	Ø 3.5 mm, 2.3 m long	806635231

||24|| Subject to modifications. Please note that some products may not be available in all countries. Please always take note of the information that is provided with the product. For more detailed information, please consult with your contact partner or directly with Richard Wolf GmbH.

LAPAROSCOPES 10 MM

TELESCOPES

3

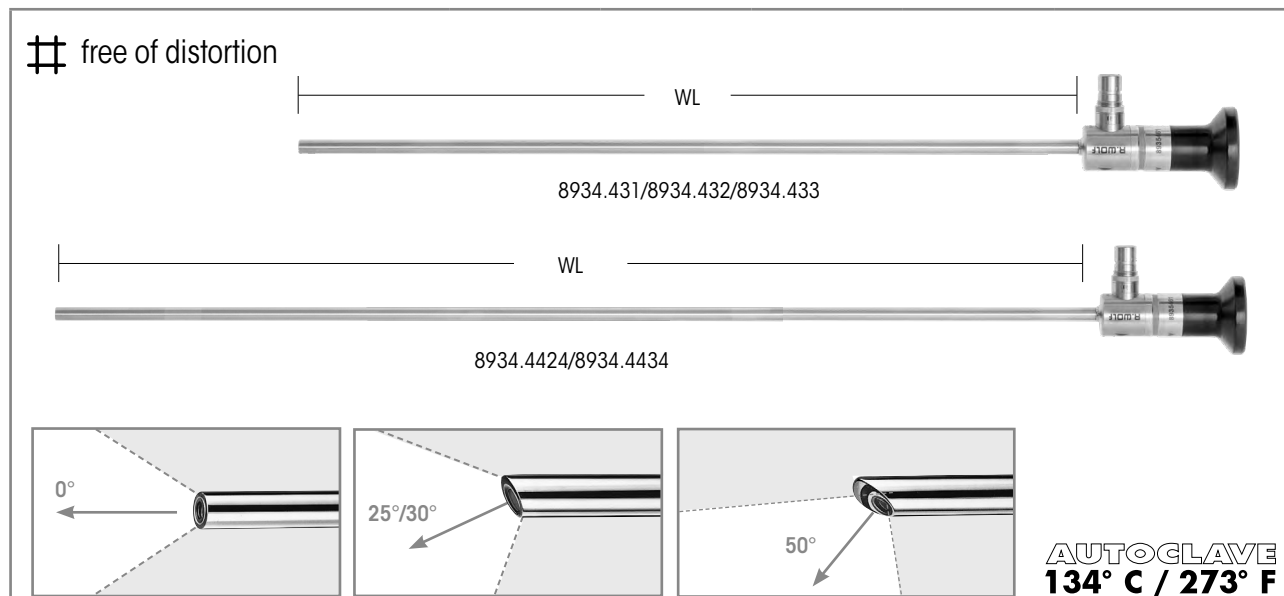

	Direction of view	WL	TL	Ø	Product no.
PANOVIEW Telescope 0° Ø 10 mm WL 307 mm	0°	307 mm	375 mm	10 mm	8934.431
PANOVIEW Telescope 30° Ø 10 mm WL 307 mm	30°	307 mm	375 mm		8934.432
PANOVIEW Telescope 50° Ø 10 mm WL 310 mm	50°	310 mm	378 mm		8934.433
PANOVIEW PLUS Telescope 25° Ø 10 mm WL 438 mm	25°	438 mm	507 mm		8934.4424
PANOVIEW PLUS Telescope 50° Ø 10 mm WL 447 mm	50°	447 mm	516 mm		8934.4434

Recommended accessories		Product no.
Perforated basket for standard telescope 2 (for telescope 8934.431/.432/.433)	(W x H x D) 481 x 54 x 59 mm	38016
Perforated basket for standard telescope 3 (for telescope 8934.4424/.4434)	(W x H x D) 619 x 54 x 59 mm	38017
Fiber lightcable bndl consisting of: Fiber light cable Ø 5 mm TL 2.3 m (80665023), projector-side adapter (8095.07), and endoscope-side adapter (809509)	Ø 5.0 mm, 2.3 m long	806650231
Fusion Fiber light cable bndl consisting of: Fiber light cable Ø 5 mm TL 2.3 m (80655023), projector-side adapter (8095.07), and endoscope-side adapter (809509)	Ø 5.0 mm, 2.3 m long	806550231

1124|| Subject to modifications. Please note that some products may not be available in all countries. Please always take note of the information that is provided with the product. For more detailed information, please consult with your contact partner or directly with Richard Wolf GmbH.

3D ENDOSCOPE 10 MM

free of distortion

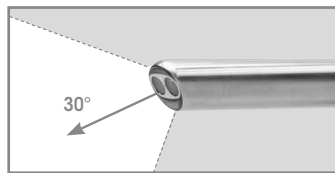
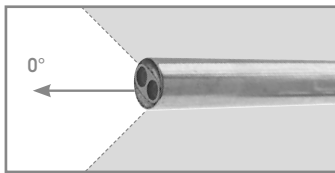
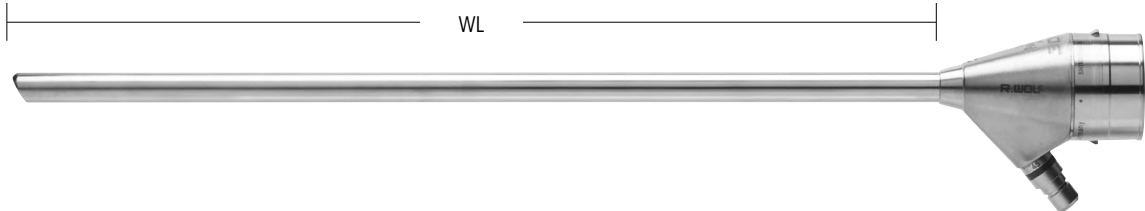

AUTOCLAVE
134° C / 273° F

	Direction of view	WL	TL	Ø	Product no.
3D endoscope 0° Ø 10 mm WL 300 mm	0°	300 mm	366 mm	10 mm	8934631
3D endoscope 0° Ø 10 mm WL 435 mm		435 mm	500 mm		89344631
3D endoscope 30° Ø 10 mm WL 301 mm	30°	301 mm	366 mm		8934632
3D endoscope 30° Ø 10 mm WL 435 mm		435 mm	501 mm		89344632

Recommended accessories		Product no.
Perforated basket for 3D telescope 	(W x H x D): 583 x 200 x 80 mm	38014
Fusion Fiber light cable bndl consisting of: Fiber light cable Ø 5 mm TL 2.3 m (80655023), projector-side, adapter (8095.07), and endoscope-side adapter (809509)	Ø 5.0 mm, 2.3 m long	806550231

112411 Subject to modifications. Please note that some products may not be available in all countries. Please always take note of the information that is provided with the product. For more detailed information, please consult with your contact partner or directly with Richard Wolf GmbH.

SURGICAL LAPAROSCOPE 10 MM

FOR ONE HOLE APPENDECTOMY

TELESOPES

3

free of distortion

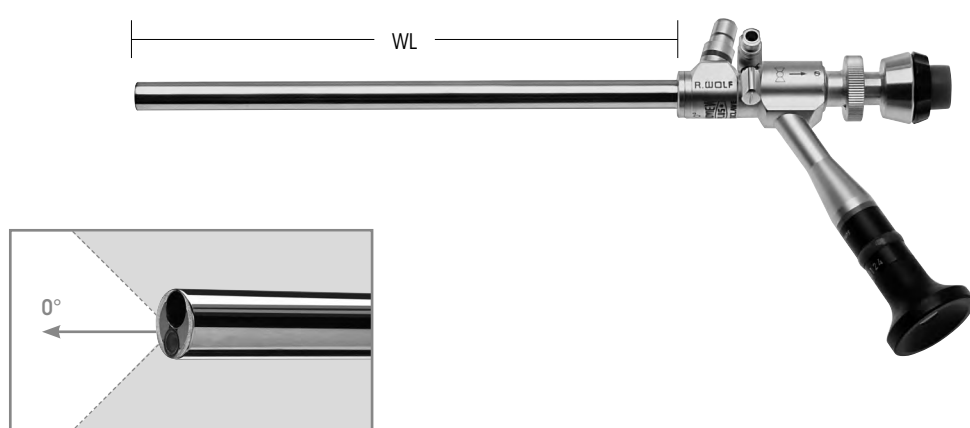

AUTOCLAVE
134° C / 273° F

	Direction of view	WL	TL	Ø	Working channel Ø	Product no.
PANOVIEW PLUS OR endoscope 0° Ø 10 mm WL 188 mm with lateral eyepiece	0°	188 mm	285 mm	10 mm	5.1 mm	8915.501

Recommended accessories		Product no.
Universal perforated basket 4 (W x H x D): 538 x 117 x 250 mm		33004
for this: Instrument mat for perforated basket		33001
Fiber light cable bndl consisting of: Fiber light cable Ø 5 mm TL 2.3 m (80655023), projector-side adapter (8095.07), and endoscope-side adapter (809509)	Ø 5.0 mm, 2.3 m long	806650231
Fusion Fiber light cable bndl consisting of: Fiber light cable Ø 5 mm TL 2.3 m (80655023), projector-side adapter (8095.07), and endoscope-side adapter (809509)	Ø 5.0 mm, 2.3 m long	806550231

11241 Subject to modifications. Please note that some products may not be available in all countries. Please always take note of the information that is provided with the product. For more detailed information, please consult with your contact partner or directly with Richard Wolf GmbH.



4K
UHD

ICG
NIR

AUTOCLAVE
134° C / 273° F



0°



30°



50°

	Direction of view	WL	TL	Ø	Product no.
PANOVIEW ULTRA Telescope 0° Ø 10 mm WL 305 mm	0°	305 mm	375 mm	10 mm	8934461
PANOVIEW ULTRA Telescope 30° Ø 10 mm WL 305 mm	30°				8934462
PANOVIEW ULTRA Telescope 50° Ø 10 mm WL 305 mm	50°				8934463

Note: Compatible with System green (see Imaging Catalog) (ICG/NIR-capable) and its recommended Fusion fiber light cable

Recommended accessories		Product no.
Perforated basket for standard telescope 2	(W x H x D) 481 x 54 x 59 mm	38016
Fiber lightcable bndl consisting of: Fiber light cable Ø 5 mm TL 2.3 m (80665023), projector-side adapter (8095.07), and endoscope-side adapter (809509)	Ø 5.0 mm, 2.3 m long	806650231
Fusion fiber lightcable bndl consisting of: Fiber light cable Ø 5 mm TL 2.3 m (80655023), projector-side adapter (8095.07), and endoscope-side adapter (809509)	Ø 5.0 mm, 2.3 m long	806550231

||24|| Subject to modifications. Please note that some products may not be available in all countries. Please always take note of the information that is provided with the product. For more detailed information, please consult with your contact partner or directly with Richard Wolf GmbH.

AUTOCLAVE
134° C / 273° F

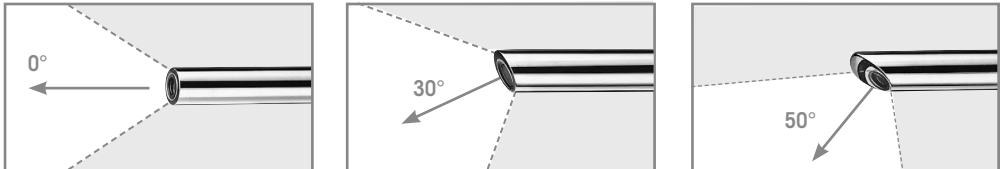

	Direction of view	WL	TL	Ø	Product no.
PANOVIEW ULTRA Telescope 0° Ø 10 mm WL 440 mm	0°	440 mm	510 mm	10 mm	89344416
PANOVIEW ULTRA Telescope 30° Ø 10 mm WL 440 mm	30°				89344426
PANOVIEW ULTRA Telescope 50° Ø 10 mm WL 440 mm	50°				89344436

Note: Compatible with System green (see Imaging Catalog) (ICG/NIR-capable) and its recommended Fusion fiber light cable

Recommended accessories		Product no.
Perforated basket for standard telescope 3	(W x H x D) 619 x 54 x 59 mm	38017
Fiber lightcable bndl consisting of: Fiber light cable Ø 5 mm TL 2.3 m (80665023), projector-side adapter (8095.07), and endoscope-side adapter (809509)	Ø 5.0 mm, 2.3 m long	806650231
Fusion Fiber light cable bndl consisting of: Fiber light cable Ø 5 mm TL 2.3 m (80655023), projector-side adapter (8095.07), and endoscope-side adapter (809509)	Ø 5.0 mm, 2.3 m long	806550231

LAPAROSCOPES

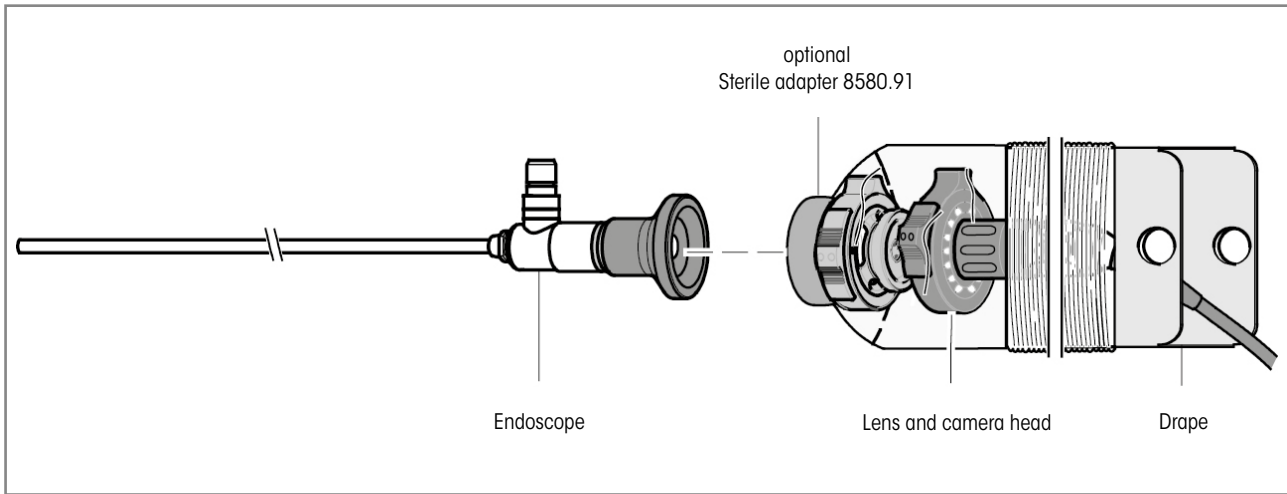

ACCESSORIES

			Product no.
	Sterile adapter	immersible and autoclavable for changing telescopes	8580.91





||24|| Subject to modifications. Please note that some products may not be available in all countries. Please always take note of the information that is provided with the product. For more detailed information, please consult with your contact partner or directly with Richard Wolf GmbH.

TROCAR SLEEVES 2.2 MM

				Tip triangular	
				Trocar tip triangular Size 2.2 mm	
Plastic sheath tube with thread	WL	Capacity	Product no.	WL 82 mm	
Trocar sleeve capacity 2.2 mm WL 60 mm with universal sealing valve	60 mm	2.2 mm	8309.072	8309.121	

Accessories	Product no.
Rubber cap capacity 0.8 mm (PACK= 10 PCS) red	88.01

TROCAR SLEEVES 2.5 MM







Trocar sleeve with insufflation connector						Tip triangular 
Stainless steel sheath tube, smooth				WL	Capacity	Product no.
Trocar sleeve capacity 2.5 mm WL 55 mm				55 mm	2.5 mm	8309.012
				WL 82 mm		
Trocar sleeve capacity 2.5 mm WL 95 mm				95 mm	2.5 mm	8309.014
				WL 119 mm		

Accessories	Product no.
Rubber cap capacity 0.8 mm (PACK= 10 PCS) red	88.01

||24|| Subject to modifications. Please note that some products may not be available in all countries. Please always take note of the information that is provided with the product. For more detailed information, please consult with your contact partner or directly with Richard Wolf GmbH.

TROCAR SLEEVES 3.5 MM









WITH INSUFFLATION STOPCOCK

RIWO-ART trocar sleeves with magnetic ball valve with insufflation stopcock				Tip tapered/blunt	Tip triangular
					
				Trocar tip blunt Size 3.5 mm	Trocar tip triangular Size 3.5 mm
Stainless steel sheath tube, smooth	WL	Capacity	Product no.	WL 169 mm	WL 169 mm
Trocar sleeve straight capacity 3.5 mm WL 100 mm	 100 mm	3.5 mm	8903.014	8903.103	8903.123
Plastic sheath tube with thread					
Trocar sleeve straight capacity 3.5 mm WL 100 mm	 100 mm	3.5 mm	8903.034	8903.103	8903.123
				WL 129 mm	WL 129 mm
Trocar sleeve slanted capacity 3.5 mm WL 60 mm	 60 mm	3.5 mm	8903.072	8903.101	8903.121

Accessories	Product no.
Spare ball capacity 5.5 mm	8921.901
Spare O rings capacity 3.5 mm (PACK= 10 PCS), capacity Ø 3.5–5.5 mm	8921.951
Sealing cap capacity 2.4–3.4 mm (PACK= 10 PCS) red	89.01
Stopcock insert bndl cap. 3.0 mm (PACK= 5 PCS)	896.0002

Trocar sleeve with membrane valve				Tip tapered/blunt	
				Trocar tip blunt Size 3.5 mm	
Plastic sheath tube with distal screw anchor	WL	Capacity	Product no.	WL 169 mm	
Trocar sleeve straight capacity 3.5 mm WL 40 mm	 40 mm	3.5 mm	8929.223	8903.103	









TROCAR SLEEVES 5.5 MM

RIWO-ART trocar sleeves with magnetic ball valve with insufflation stopcock 				Tip tapered/blunt	Tip tapered/ pointed	Tip triangular
				Trocar tip blunt Size 5.5 mm	Trocar tip pointed Size 5.5 mm	Trocar tip triangular Size 5.5 mm
Stainless steel sheath tube	WL	Capacity	Product no.	WL 169 mm	WL 169 mm	WL 169 mm
Trocar sleeve straight capacity 5.5 mm WL 100 mm smooth 	100 mm	5.5 mm	8921.014	8921.103	8921.113	8921.123
Trocar sleeve slanted capacity 5.5 mm WL 100 mm smooth 	100 mm	5.5 mm	8921.013	8921.103	8921.113	8921.123
Trocar sleeve straight capacity 5.5 mm WL 100 mm with thread 	100 mm	5.5 mm	8921.024	8921.103	8921.113	8921.123
Trocar sleeve slanted capacity 5.5 mm WL 100 mm with thread 	100 mm	5.5 mm	8921.023	8921.103	8921.113	8921.123
Plastic tube Trocar sleeve straight capacity 5.5 mm WL 100 mm with thread 	100 mm	5.5 mm	8921.034	8921.103	8921.113	8921.123
				WL 219 mm	WL 219 mm	WL 219 mm
Trocar sleeve straight capacity 5.5 mm WL 150 mm smooth 	150 mm	5.5 mm	8921.016	8921.105	8921.115	8921.125
Trocar sleeve straight capacity 5.5 mm WL 150 mm with thread 	150 mm	5.5 mm	8921.026	8921.105	8921.115	8921.125

Accessories	Product no.
Spare ball capacity 5.5 mm	8921.901
Spare O rings capacity 3.5 mm (PACK= 10 PCS), capacity Ø 3.5–5.5 mm	8921.951
Sealing cap capacity 3.4–5.1 mm (PACK= 10 PCS) blue	89.02
Stopcock insert bndl cap. 3.0 mm (PACK= 5 PCS)	896.0002

1124|| Subject to modifications. Please note that some products may not be available in all countries. Please always take note of the information that is provided with the product. For more detailed information, please consult with your contact partner or directly with Richard Wolf GmbH.

TROCAR SLEEVES 5.5 MM





RIWO-ART trocar sleeves with magnetic ball valve 				Tip tapered/blunt	Tip tapered/ pointed	Tip triangular
				Trocar tip blunt Size 5.5 mm	Trocar tip pointed Size 5.5 mm	Trocar tip triangular Size 5.5 mm
Stainless steel sheath tube	WL	Capacity	Product no.	WL 129 mm	WL 129 mm	WL 129 mm
Trocar sleeve straight capacity 5.5 mm WL 60 mm smooth 	60 mm	5.5 mm	8921.052	8921.101	8921.111	8921.121
Trocar sleeve slanted capacity 5.5 mm WL 60 mm smooth 	60 mm	5.5 mm	8921.051	8921.101	8921.111	8921.121
Trocar sleeve straight capacity 5.5 mm WL 60 mm with thread 	60 mm	5.5 mm	8921.062	8921.101	8921.111	8921.121
Trocar sleeve slanted capacity 5.5 mm WL 60 mm with thread 	60 mm	5.5 mm	8921.061	8921.101	8921.111	8921.121
Plastic tube Trocar sleeve straight capacity 5.5 mm WL 60 mm with thread 	60 mm	5.5 mm	8921.072	8921.101	8921.111	8921.121
				WL 169 mm	WL 169 mm	WL 169 mm
Trocar sleeve straight capacity 5.5 mm WL 100 mm smooth 	100 mm	5.5 mm	8921.054	8921.103	8921.113	8921.123
Trocar sleeve straight capacity 5.5 mm WL 100 mm with thread 	100 mm	5.5 mm	8921.053	8921.103	8921.113	8921.123

Accessories	Product no.
Spare ball capacity 5.5 mm	8921.901
Spare O rings capacity 3.5 mm (PACK= 10 PCS), capacity Ø 3.5–5.5 mm	8921.951
Sealing cap capacity 3.4–5.1 mm (PACK= 10 PCS) blue	89.02

TROTEC

TROCAR WITH AUTOMATIC PROTECTIVE FUNCTION

FOR A SINGLE PORT OPERATIONAL PROCEDURE

Trocar consisting of:		Product no.	for RIWO-ART trocar sleeve with WL 100 mm, Ø 5,5 mm
Sheath with trocar tip Size 5.5 mm WL 181 mm	Tapered tip 	8921.132	
Sheath with trocar tip Size 5.5 mm WL 181 mm	Two-sided tip 	8921.134	
Spring-loaded protective rod WL 184 mm		8923.135	

Accessories	Product no.
Protective cap	8923.991

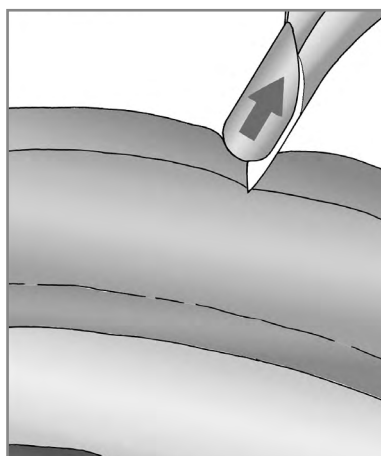

Protective tip automatically pushes back into the cannula through contact with the abdominal wall

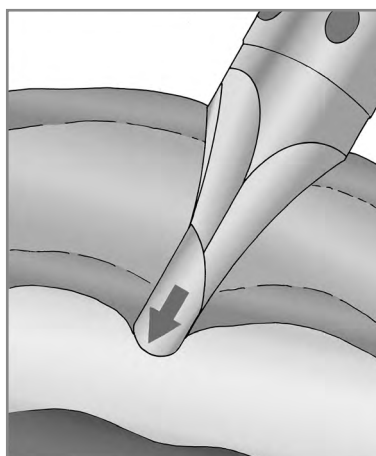



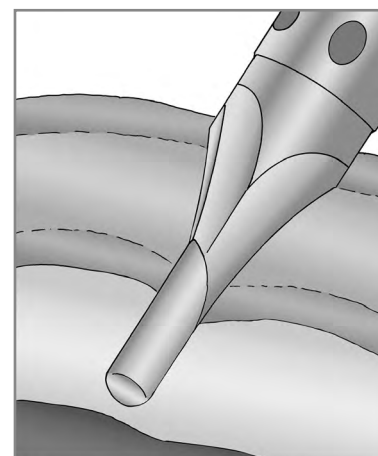

The protective tip advances into the free abdomen immediately after penetration of the peritoneum



The atraumatic protective tip in a far distal position prevents perforation of organs and vessels

TROCAR SLEEVE 5.5 MM/5.8 MM

PLASTIC WITH SEALING MEMBRANE

 <p>AUTOCLAVE 134° C / 273° F</p>					Tip tapered/blunt	Tip tapered/pointed	Tip triangular
							
					Trocar tip blunt Size 5.5 mm	Trocar tip pointed Size 5.5 mm	Trocar tip triangular Size 5.5 mm
Flexible plastic sheath tube with thread	WL	Capacity	with stopcock	Product no.	WL 104 mm	WL 104 mm	WL 104 mm
Trocar sleeve straight capacity 5.5 mm WL 62 mm with membrane valve	62 mm	5.5 mm	●	8919.333	8919.3311	8919.3312	8919.3313
				8919.331			
					WL 144 mm	WL 144 mm	WL 144 mm
Trocar sleeve straight capacity 5.5 mm WL 102 mm with membrane valve	102 mm	5.5 mm	●	8919.353	8919.3511	8919.3512	8919.3513
				8919.351			

for curved instruments					Tip tapered/blunt	Tip tapered/pointed	Tip triangular	Tip tapered/blunt
 <p>AUTOCLAVE 134° C / 273° F</p>								
					Trocar tip blunt Size 5.5 mm	Trocar tip pointed Size 5.5 mm	Trocar tip triangular Size 5.5 mm	Trocar tip blunt Size 5.5 mm
Flexible plastic sheath tube with thread	WL	Capacity	Product no.	WL 80 mm	WL 80 mm	WL 80 mm	WL 80 mm	
Trocar sleeve straight capacity 5.8 mm WL 62 mm with membrane valve	62 mm	5.8 mm	8905.331	8905.3311	8905.3312	8905.3313	8905.3315	
					WL 120 mm	WL 120 mm	WL 120 mm	WL 120 mm
Trocar sleeve straight capacity 5.8 mm WL 102 mm with membrane valve	102 mm	5.8 mm	8905.3515	8905.3511	8905.3512	8905.3513	8905.3515	

Accessories	Product no.
Sealing membrane Ø 17 mm, yellow (PACK= 10 PCS)	89.103
Stopcock insert bndl cap 3.0 mm (PACK= 5 PCS)	896.0002









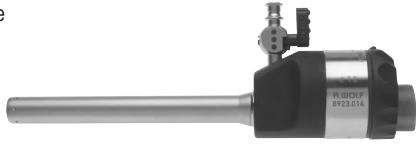

TROCAR SLEEVE 5.7 MM/7 MM/10 MM/12.5 MM

FLEXIBLE PLASTIC SHEATH TUBE

				Tip tapered/blunt
				Trocar tip blunt
Flexible plastic sheath tube with thread	WL	Capacity	Product no.	Size 5.5 mm/WL 83 mm
Trocar sleeve straight capacity 5.7 mm WL 60 mm with rubber cap	60 mm	5.7 mm	8906.051	8906.151

				Tip tapered/blunt
				Trocar tip blunt
Ribbed flexible plastic sheath tube	WL	Capacity	Product no.	Size 7.3 mm/TL 108 mm
Trocar sleeve flexible capacity 7 mm WL 74 mm with universal seal	74 mm	7 mm	8906.001	8913.11
				Size 10 mm/TL 85 mm
Trocar sleeve flexible capacity 10 mm WL 56 mm with universal seal	56 mm	10 mm	8906.011	8906.111
				Size 12.5 mm/TL 86 mm
Trocar sleeve flexible capacity 12.5 mm WL 57 mm with universal seal	57 mm	12.5 mm	8906.031	8906.131

TROCAR SLEEVE 10 MM WITH INSUFFLATION STOPCOCK

RIWO-ART trocar sleeves with magnetic ball valve 					Tip tapered/blunt	Tip tapered/pointed	Tip triangular
					 Trocar tip blunt Size 10 mm	 Trocar tip pointed Size 10 mm	 Trocar tip triangular Size 10 mm
Stainless steel sheath tube		WL	Capacity	Product no.	WL 164 mm	WL 164 mm	WL 164 mm
Trocar sleeve straight capacity 10 mm WL 100 mm 	100 mm	10 mm	8923.014	8923.103	8923.113	8923.123	
Trocar sleeve slanted capacity 10 mm WL 100 mm 	100 mm	10 mm	8923.013	8923.103	8923.113	8923.123	
Trocar sleeve straight capacity 10 mm WL 100 mm with thread 	100 mm	10 mm	8923.024	8923.103	8923.113	8923.123	
Trocar sleeve slanted capacity 10 mm WL 100 mm with thread 	100 mm	10 mm	8923.023	8923.103	8923.113	8923.123	
					WL 214 mm	WL 214 mm	WL 214 mm
Trocar sleeve straight capacity 10 mm WL 150 mm 	150 mm	10 mm	8923.016	-	8923.115	8923.125	
Trocar sleeve straight capacity 10 mm WL 150 mm with thread 	150 mm	10 mm	8923.026	-	8923.115	8923.125	

Accessories	Product no.
Spare ball capacity 7 mm	8923901
Spare O rings capacity 7 mm (PACK= 10 PCS), capacity Ø 7–12.5 mm	8923951
Sealing cap capacity 9.5–10.1 mm (PACK= 10 PCS) red	8908
Stopcock insert bndl cap. 3.0 mm (PACK= 5 PCS)	896.0002





1124|| Subject to modifications. Please note that some products may not be available in all countries. Please always take note of the information that is provided with the product. For more detailed information, please consult with your contact partner or directly with Richard Wolf GmbH.

TROTEC

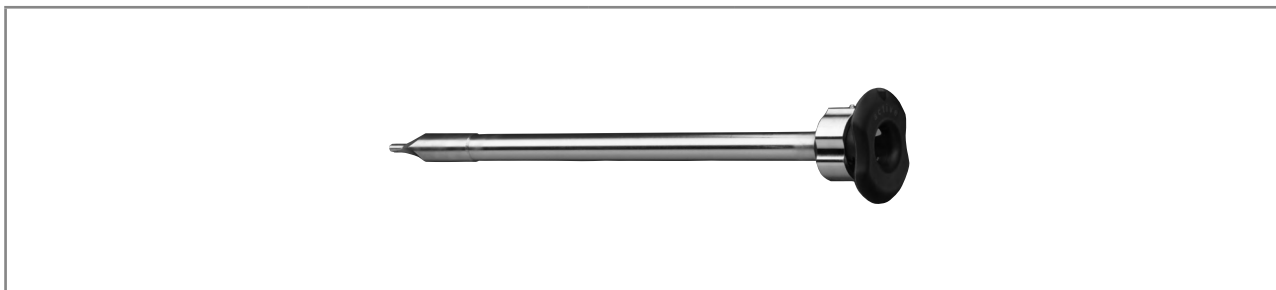
TROCAR WITH AUTOMATIC PROTECTIVE FUNCTION

FOR TROCAR SLEEVES 10 MM



Trocar consisting of:		Product no.	for RIWO-ART trocar sleeve with WL 100 mm, ø 10 mm
Sheath with trocar tip Size 10 mm WL 181 mm	Tapered tip 	8923.132	
Sheath with trocar tip Size 10 mm WL 181 mm	Two-sided tip 	8923.134	
Spring-loaded protective rod WL 184 mm		8923.135	

Accessories	Product no.
Protective cap	8923.991

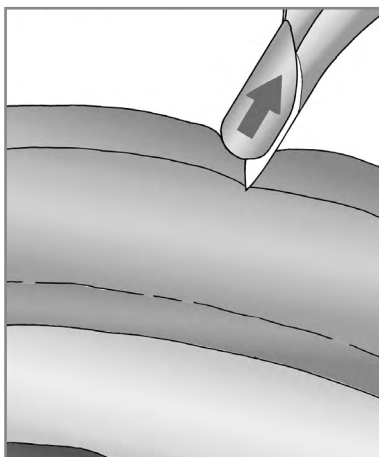

Protective tip automatically pushes back into the cannula through contact with the abdominal wall

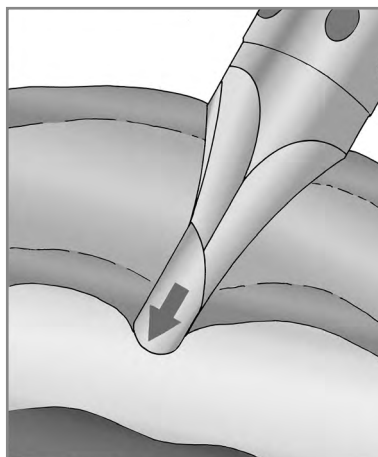



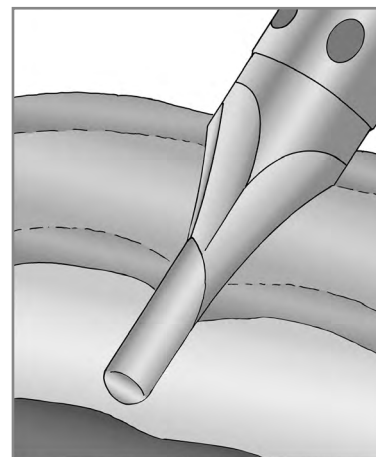

The protective tip advances into the free abdomen immediately after penetration of the peritoneum



The atraumatic protective tip in a far distal position prevents perforation of organs and vessels

HIGH FLOW TROCAR SLEEVE 10 MM WITH CONNECTOR FOR HIGH FLOW INSUFFLATION TUBE







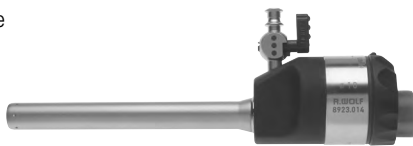

RIWO-ART trocar sleeves with magnetic ball valve 				Tip tapered/blunt 	Tip tapered/pointed 	Tip triangular 
				Trocar tip blunt Size 10 mm	Trocar tip pointed Size 10 mm	Trocar tip triangular Size 10 mm
Stainless steel sheath tube	WL	Capacity	Product no.	WL 164 mm	WL 164 mm	WL 164 mm
Trocar sleeve straight capacity 10 mm WL 100 mm 	100 mm	10 mm	8923.042	8923.103	8923.113	8923.123
for this:						Product no.
Reducing adapter (PACK= 5 PCS) 	for reduction from Ø 7 mm, Ø 10 mm, and Ø 12.5 mm to Ø 5.5 mm				8923802	

Accessories	Product no.
Spare ball capacity 7 mm	8923901
Spare O rings capacity 7 mm (PACK= 10 PCS), capacity Ø 7–12.5 mm	8923951
Sealing cap capacity 9.5–10.1 mm (PACK= 10 PCS) red	8908

1124|| Subject to modifications. Please note that some products may not be available in all countries. Please always take note of the information that is provided with the product. For more detailed information, please consult with your contact partner or directly with Richard Wolf GmbH.



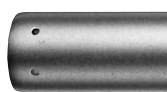

TROCAR SLEEVE 12.5 MM

WITH INSUFFLATION STOPCOCK

RIWO-ART trocar sleeves with magnetic ball valve 				Tip tapered/blunt 	Tip tapered/pointed 	Tip triangular 	
				Trocar tip blunt Size 12.7 mm	Trocar tip pointed Size 12.7 mm	Trocar tip triangular Size 12.7 mm	
Stainless steel sheath tube		WL	Capacity	Product no.	WL 164 mm	WL 164 mm	WL 164 mm
Trocar sleeve straight capacity 12.5 mm WL 100 mm 	100 mm	12.5 mm	8924.014	8924.103	8924.113	8924.123	
Trocar sleeve slanted capacity 12.5 mm WL 100 mm 	100 mm	12.5 mm	8924.013	8924.103	8924.113	8924.123	
				WL 214 mm	WL 214 mm	WL 214 mm	
Trocar sleeve straight capacity 12.5 mm WL 150 mm with thread 	150 mm	12.5 mm	8924.026	-	8924.115	8924.125	
Trocar sleeve straight capacity 12.5 mm WL 150 mm 	150 mm	12.5 mm	8924.016	-	8924.115	8924.125	
for this:							
Reducing adapter (PACK= 5 PCS) 		for reduction from Ø 10 mm to Ø 5.5 mm and Ø 12.5 mm to Ø 5.5 mm				8923.802	
		for reduction from Ø 12.5 mm to Ø 10 mm				8924.802	

Accessories	Product no.
Spare ball capacity 7 mm	8923.901
Spare O rings capacity 7 mm (PACK= 10 PCS), capacity Ø 7–12.5 mm	8923.951
Sealing cap capacity 9.5–10.1 mm (PACK= 10 PCS) red	89.08
Stopcock insert bndl cap. 3.0 mm (PACK= 5 PCS)	896.0002

TROTEC
TROCAR WITH AUTOMATIC PROTECTIVE FUNCTION
 FOR TROCAR SLEEVES 12.5 MM

			
Trocar consisting of:		Product no.	for RIWO-ART trocar sleeve with WL 100 mm, Ø 12,5 mm
Sheath with trocar tip Size 12.5 mm WL 181 mm	Two-sided tip 	8924.134	
Spring-loaded protective rod WL 184 mm		8923.135	

Accessories	Product no.
Protective cap	8923.991

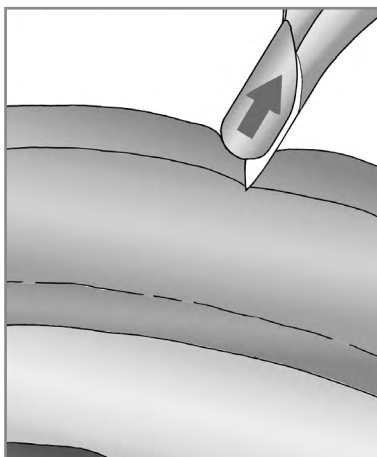

Protective tip automatically pushes back into the cannula through contact with the abdominal wall

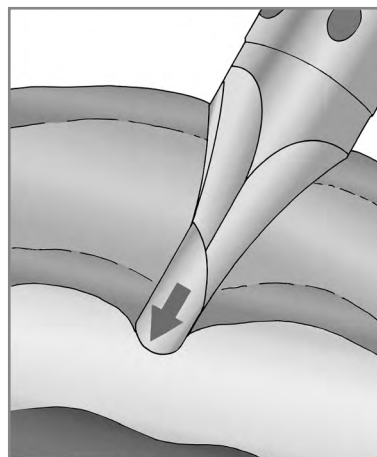

The protective tip advances into the free abdomen immediately after penetration of the peritoneum

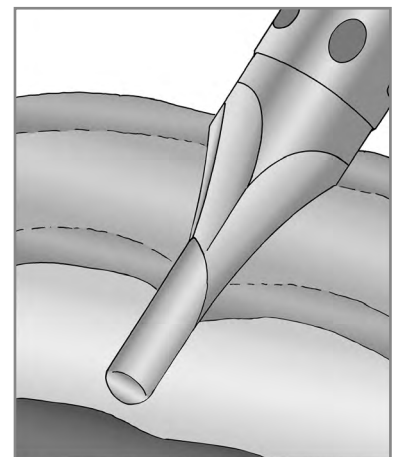

The atraumatic protective tip in a far distal position prevents perforation of organs and vessels

DILATATION AND EXTRACTION INSTRUMENTS

5.5 TO 10/10 TO 12.5 MM

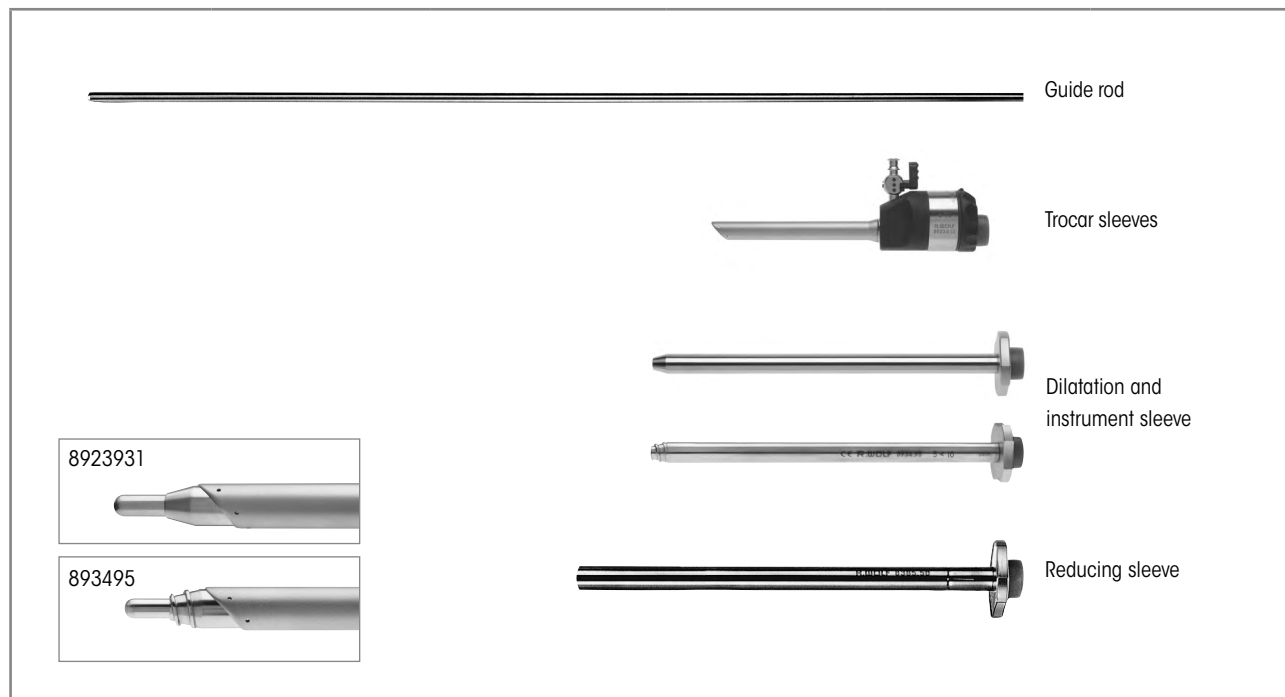

Incision widening	Guide rod	Trocar sleeve slanted	Dilatation sleeve	Instrument sleeve	Reducing sleeve
3.5 mm < 5.5 mm	-	8921.013 capacity 5.5 mm WL 100 mm			8383.78 Size 5 mm L 155 mm
5.5 mm < 10 mm	8923.921 5.5 mm TL 500 mm	8923.013 capacity 10 mm WL 100 mm	8923.931 Size 10 mm WL 170 mm	8385.50 10 mm WL 170 mm	
5.0 mm < 10 mm	8934.951 5 mm TL 500 mm		8934.95 Size 10 mm WL 172 mm		
10 mm < 12.5 mm		8924.013 capacity 12.5 mm WL 100 mm			8941.901 12 mm WL 180 mm
5.5 mm < 12.5 mm					8941.951 12 mm WL 180 mm
10 mm < 15 mm	8943.901 10 mm TL 500 mm				

11241 Subject to modifications. Please note that some products may not be available in all countries. Please always take note of the information that is provided with the product. For more detailed information, please consult with your contact partner or directly with Richard Wolf GmbH.

REDUCING SLEEVES FOR RIWO-ART TROCAR SLEEVES

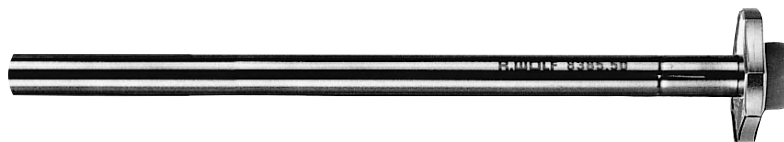



Stainless steel sheath tube	Outer Ø	WL	for instruments	Product no.
Reducing sleeve Size 5 mm WL 155 mm	5 mm	155 mm	3.5 mm	8383.78
Instrument sleeve 10 mm WL 170 mm	10 mm	170 mm	5.5 mm	8385.50
Reducing sleeve 12 mm WL 180 mm	12 mm	180 mm	10 mm	8941.901
Reducing sleeve 12 mm WL 180 mm	12 mm	180 mm	5.5 mm	8941.951
for this:				
Reducing adapter (PACK= 5 PCS)		for reduction from Ø 7 mm, Ø 10 mm, and Ø 12.5 mm to Ø 5.5 mm		8923802
		for reduction from Ø 12.5 mm to Ø 10 mm		8924802

Accessories	Product no.
Sealing cap capacity 3.4–5.1 mm (PACK= 10 PCS) blue	89.02
Sealing cap capacity 9.5–10.1 mm (PACK= 10 PCS) red	8908

VERES CANNULAS

FOR CREATION OF THE PNEUMOPERITONEUM

				
		Outer Ø	WL	Product no.
	VERES cannula Ø 2.1 mm WL 150 mm	2.1 mm	150 mm	8302.15
	VERES cannula Ø 2.1 mm WL 120 mm (standard length)		120 mm	8302.12
	VERES cannula Ø 2.1 mm WL 80 mm		80 mm	8302.08
for this:				
Tube with Luer-Lock connector				886.00

Accessories	Product no.
Stopcock insert bndl cap. 3.0 mm (PACK= 5 PCS)	896.0002

11241 Subject to modifications. Please note that some products may not be available in all countries. Please always take note of the information that is provided with the product. For more detailed information, please consult with your contact partner or directly with Richard Wolf GmbH.

ERAGON^{modular}

THE LAPAROSCOPIC TOOLBOX

The toolbox principle

ERAGONmodular allows the surgeon to create their ideal laparoscopic set. Ergonomic handles, diameters relevant to all medical practice, useful working lengths, and a range of jaw sections can be combined as necessary. This universal compatibility also ensures that individual trays can comprise fewer instruments – for more efficiency and one way of cutting costs

ERAGONMODULAR

5

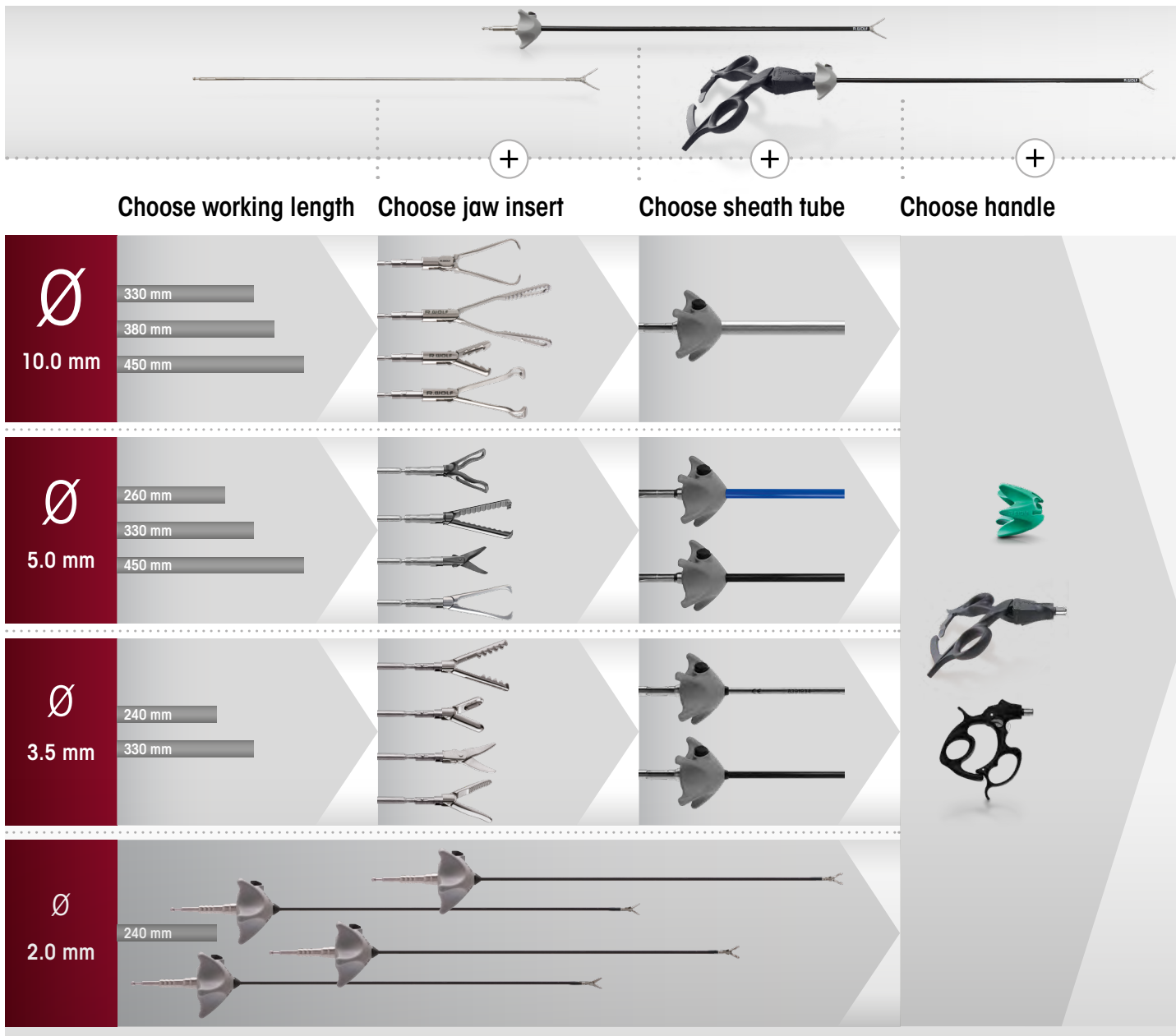





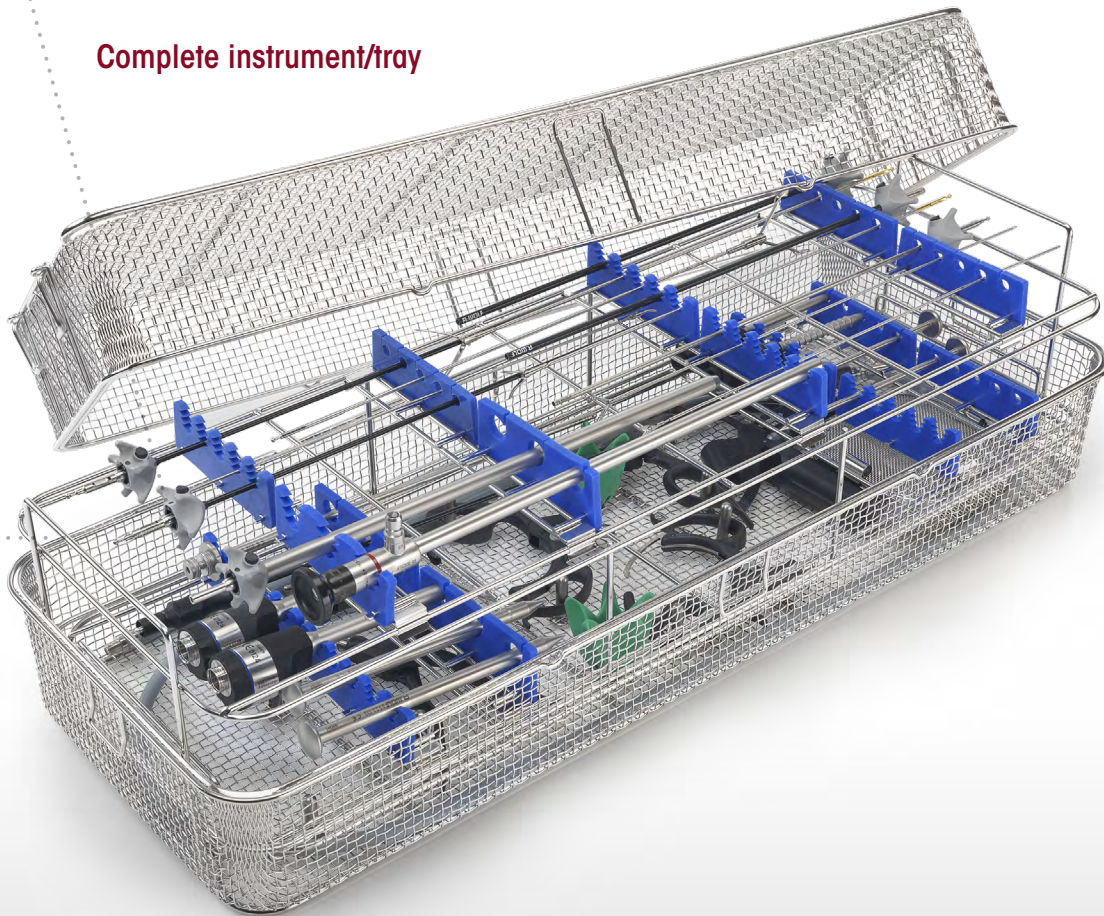







Complete instrument/tray







ERAGON *modular*
micro
Ø 2 MM, INSULATED

		Handle, axial	
 All jaw inserts and sheath tubes can also be combined with ERAGONaxial			
		without lock, with HF connector	without lock, with HF connector
Rotatable knob	Product no.	83930083	83930084
	8988	•	•

Jaw insert		Sheath tube, Ø 2.0 mm, insulated	Handle, pistol-shaped	Complete instrument
				<ul style="list-style-type: none"> • Jaw insert with sheath tube • Handle
		WL 240 mm	without lock, with HF, mono	
	JL*	Product no.	83930073	Product no.
 Scissors mono Ø 2 mm bndl	7 mm	8388200	•	•
straight, double-action				83882007
 Dissector forceps mono Ø 2 mm bndl	7 mm	8388201	•	•
straight, double-action				83882017
 Atraumatic grasping forceps mono Ø 2 mm bndl	7 mm	8388202	•	•
fenestrated, double-action				83882027

* JL = jaw length when jaw section closed (approximate measurements)
HF connection cable: see sheet GYN114/115

ERAGON modular *micro*
Ø 2 MM, INSULATED



Jaw insert		Sheath tube, Ø 2.0 mm, insulated		Handle, pistol-shaped	Complete instrument • Jaw insert with sheath tube • Handle
					
		WL 240 mm		with lock, with HF, mono	
	JL*	Product no.		83930074	Product no.
 Grasping forceps mono Ø 2 mm bndl double-action	7 mm	8388203	•	•	83882037







* JL = jaw length when jaw section closed (approximate measurements)
HF connection cable: see sheet GYN114/115

Accessories for manual and machine reprocessing		Product no.
	Irrigation adapter Ø 9 mm, length 64 mm	163502

ERAGON modular mini

Ø 3.5 MM, INSULATED

		Handle, axial	
ERAGON axial			
All jaw inserts and sheath tubes can also be combined with ERAGON axial		without lock, with HF connector	without lock, with HF connector
Rotatable knob	Product no.	83930083	83930084
	8988	•	•









Jaw insert		Sheath tube, Ø 3.5 mm, insulated		Handle, pistol-shaped	Complete instrument	
					<ul style="list-style-type: none"> • Jaw insert with sheath tube • Handle 	
		WL 240 mm	WL 330 mm	with lock, with HF, mono		
	JL*	Product no.	8390933	8391933	83930074	Product no.
	15 mm	8390207	•	•	•	83902077
curved to the left, double-action		8391207	•	•	•	83912077
	18 mm	8390221	•	•	•	83902217
long, fine tip, double-action		8391221	•	•	•	83912217
	14 mm	8390222	•	•	•	83902227
short, fine tip, double-action		8391222	•	•	•	83912227
	14 mm	8390223	•	•	•	83902237
angled, double-action		8391223	•	•	•	83912237

* JL = jaw length when jaw section closed (approximate measurements)

HF connection cable: see sheet GYN114/115

ERAGON modular mini

Ø 3.5 MM, INSULATED

Jaw insert			Sheath tube, Ø 3.5 mm, insulated		Handle, pistol-shaped		Complete instrument • Jaw insert with sheath tube • Handle
							
							WL 240 mm
	JL*	Product no.	8390933	8391933	83930073	83930074	Product no.
 Metzenbaum scissors mono Ø 3.5 mm bndl double-action	16 mm	8390215	•		•		83902157
		8391215			•		83912157
 Metzenbaum scissors mono Ø 3.5 mm bndl fine-toothed, curved, double-action	14 mm	8390224	•		•		83902247
		8391224			•		83912247
 Hook scissors mono Ø 3.5 mm bndl single-action	8 mm	8390227	•		•		83902277
		8391227			•		83912277
 Double spoon forceps mono Ø 3.5 mm bndl	12 mm	8390216	•			•	83902167
		8391216			•		83912167
 Friedel punch mono Ø 3.5 mm bndl	10 mm	8390217	•			•	83902177
		8391217			•		83912177

* JL = jaw length when jaw section closed (approximate measurements)





HF connection cable: see sheet GYN114/115







Accessories for manual and machine reprocessing		Product no.
	Irrigation adapter Ø 9 mm, length 64 mm	163502

ERAGON modular mini
Ø 3.5 MM, UNINSULATED

ERAGONMODULAR

5







		Handle, axial	
 All jaw inserts and sheath tubes can also be combined with ERAGONaxial			
		with lock, without HF connector	with lock, without HF connector, not rotatable
Rotatable knob	Product no.	83930082	83930085
	8988	.	

Jaw insert		Sheath tube, Ø 3.5 mm, uninsulated		Handle, pistol-shaped	Complete instrument	
				 with lock, without HF	• Jaw insert with sheath tube • Handle	
		WL 240 mm	WL 330 mm			
	JL*	Product no.	8390934	8391934	83930072	Product no.
 Atraumatic grasping forceps Ø 3.5 mm bndl fenestrated, double-action	14 mm	8390208	.		.	83902087
		8391208		.		.
 Atraumatic grasping forceps Ø 3.5 mm bndl fenestrated, single-action	17 mm	8390218	.		.	83902187
		8391218		.		.
 Atraumatic grasping forceps Ø 3.5 mm bndl double fenestrated, curved, single-action	17 mm	8390225	.		.	83902257
		8391225		.		.
 Atraumatic grasping forceps Ø 3.5 mm bndl fenestrated, double-action	19 mm	8390226	.		.	83902267
		8391226		.		.

* JL = jaw length when jaw section closed (approximate measurements)
 HF connection cable: see sheet GYN114/115

1124 || Subject to modifications. Please note that some products may not be available in all countries. Please always take note of the information that is provided with the product. For more detailed information, please consult with your contact partner or directly with Richard Wolf GmbH.

ERAGON modular
mini
Ø 3.5 MM, UNINSULATED







Jaw insert			Sheath tube, Ø 3.5 mm, uninsulated		Handle, pistol-shaped	Complete instrument • Jaw insert with sheath tube • Handle
						
			WL 240 mm	WL 330 mm		with lock, without HF
	JL*	Product no.	8390934	8391934	83930072	Product no.
 Grasping forceps Ø 3.5 mm bndl 13 mm fenestrated, double-action		8390219	•		•	83902197
		8391219		•		83912197
 Grasping forceps Ø 3.5 mm bndl 17 mm fenestrated, single-action		8390220	•		•	83902207
		8391220		•		83912207
 Universal grasping forceps Ø 3.5 mm bndl 14 mm double-action		8390209	•		•	83902097
		8391209		•		83912097
 Babcock forceps Ø 3.5 mm bndl 19 mm double-action		8390210	•		•	83902107
		8391210		•		83912107







* JL = jaw length when jaw section closed (approximate measurements)

HF connection cable: see sheet GYN114/115

Accessories for manual and machine reprocessing		Product no.
	Irrigation adapter Ø 9 mm, length 64 mm	163503

ERAGON modular
Ø 5.0 MM, INSULATED

		Handle, axial			
 All jaw inserts and sheath tubes can also be combined with ERAGONaxial					
		with lock	without lock, with HF connector	without lock, with HF connector	with lock, not rotatable
Rotatable knob	Product no.	83930082	83930083	83930084	83930085
	8988	•	•	•	







Jaw insert		Sheath tube, Ø 5.0 mm, insulated		Handle, pistol-shaped	Complete instrument	
					<ul style="list-style-type: none"> • Jaw insert with sheath tube • Handle 	
	JL*	Product no.	8393933	8394933	83930074	Product no.
	21 mm	8393.281	•		•	83932817
curved, with fine cross toothing, double-action		8394.281		•	•	83942817
	22 mm	8393.283	•		•	83932837
angled, fine, pyramid-shaped toothing, double-action						
	21 mm	8393.185	•		•	83931857
fenestrated, with fine cross toothing, 15 mm long, single-action						
	26 mm	8393.184	•		•	83931847
fenestrated, with fine cross toothing, 20 mm long, single-action		8394.184		•	•	83941847

* JL = jaw length when jaw section closed (approximate measurements)

HF connection cable: see sheet GYN114/115

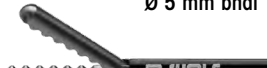
ERAGON modular







Ø 5.0 MM, INSULATED







Jaw insert			Sheath tube, Ø 5.0 mm, insulated			Handle, pistol-shaped			Complete instrument • Jaw insert with sheath tube • Handle
			SL 260 mm	SL 330 mm	SL 450 mm	with lock, without HF	without lock, with HF, mono	with lock, with HF, mono	
	JL*	Product no.	8392933	8393933	8394933	83930072	83930073	83930074	Product no.
 Dolphin dissector forceps mono Ø 5 mm bndl angled, with fine cross-toothing, with channel, narrow, 15 mm long, double-action	17 mm	8393.285		•				•	83932857
 Dissector forceps mono Ø 5 mm bndl fine pyramid-shaped toothing, narrow, 18 mm, double-action	23 mm	8393.289		•				•	83932897
 Atraumatic grasping forceps Ø 5 mm bndl Channel with wavy tooth edge, 20 mm, single-action	26 mm	8393.292		•			•		83932925
 Atraumatic grasping forceps Ø 5 mm bndl Channel with wavy tooth edge, 20 mm, double-action	26 mm	8393.293		•			•		83932935
		8394.293			•		•		83942935
 Grasping forceps, mono Ø 5 mm bndl fine, pyramid-shaped toothing, narrow double-action	19 mm	8393.288		•				•	83932887
 Atraumatic grasping forceps mono Ø 5 mm bndl fenestrated, with cross toothing, double-action	19 mm	8392.181	•					•	83921817
		8393.181		•				•	83931817
		8394.181			•			•	83941817

* JL = jaw length when jaw section closed (approximate measurements)

HF connection cable: see sheet GYN114/115

ERAGON modular
Ø 5.0 MM, INSULATED

		Handle, axial			
 All jaw inserts and sheath tubes can also be combined with ERAGONaxial					
		with lock	without lock, with HF connector	without lock, with HF connector	with lock, not rotatable
Rotatable knob	Product no.	83930082	83930083	83930084	83930085
	8988	•	•	•	







Jaw insert		Sheath tube, Ø 5.0 mm, insulated		Handle, pistol-shaped		Complete instrument • Jaw insert with sheath tube • Handle	
							
		SL 330 mm	SL 450 mm	with lock, without HF	without lock, with HF, mono		
	JL*	Product no.	8393933	8394933	83930072	83930073	Product no.
 Atraumatic grasping forceps mono Ø 5 mm bndl 18 mm smooth, double-action		8393.195	•			•	83931957
		8394.195		•			•
 Babcock forceps Ø 5 mm bndl 24 mm Gripping surface with fine cross tothing, double-action		8393.186	•			•	83931867
		8393.187	•			•	83931877
 Babcock forceps Ø 5 mm bndl 26 mm large distal gripping surface with fine cross tothing, double-action		8394.187		•		•	83941877
		8393.190	•			•	83931907
 Debakey forceps Ø 5 mm bndl 39 mm atraumatic clamp, double-action			•			•	

* JL = jaw length when jaw section closed (approximate measurements)

HF connection cable: see sheet GYN114/115

ERAGON modular







Ø 5.0 MM, INSULATED









Jaw insert			Sheath tube, Ø 5.0 mm, insulated		Handle, pistol-shaped		Complete instrument • Jaw insert with sheath tube • Handle
			SL 330 mm	SL 450 mm	with lock, without HF	with lock, with HF, mono	
	JL*	Product no.	8393933	8394933	83930072	83930074	Product no.
 Debaque forceps Ø 5 mm bndl atraumatic clamp, double-action	48 mm	8393191	•		•		83931917
 Grasping forceps, mono Ø 5 mm bndl with a row of teeth, double-action	17 mm	8393.485	•			•	83934857
 Grasping forceps, mono Ø 5 mm bndl with one tooth, fine cross toothing, narrow, double-action	19 mm	8393.486	•			•	83934867
 Grasping forceps, mono Ø 5 mm bndl with two teeth, fine cross toothing, single-action	17 mm	8393.487	•			•	83934877
 Grasping forceps Ø 5 mm bndl with two teeth wavy gripping surface, double-action	26 mm	8393.490	•		•		83934907
		8394.490		•	•		83944907
 Petelin dissector forceps mono Ø 5 mm bndl angled 30° to the left, with cross toothing, single-action	17 mm	8393.282	•			•	83932827

* JL = jaw length when jaw section closed (approximate measurements)

HF connection cable: see sheet GYN114/115

ERAGON^{modular}
 Ø 5.0 MM, INSULATED







		Handle, axial			
 All jaw inserts and sheath tubes can also be combined with ERAGONaxial					
		with lock	without lock, with HF connector	without lock, with HF connector	with lock, not rotatable
Rotatable knob	Product no.	83930082	83930083	83930084	83930085
	8988	•	•	•	

Jaw insert		Sheath tube, Ø 5.0 mm, insulated	Handle, pistol-shaped			Complete instrument	
		 SL 330 mm				• Jaw insert with sheath tube • Handle	
	JL*	Product no.	8393933	83930072	83930073	83930074	Product no.
 Plate-shaped grasping forceps mono Ø 5 mm bndl fenestrated with fine cross tothing, double-action	18 mm	8393.182	•			•	83931827
 Grasping forceps mono Ø 5 mm bndl with cross tothing, double-action	21 mm	8393.183	•		•		83931837
 Grasping forceps mono Ø 5 mm bndl distal cross tothing with channel, double-action	15 mm	8393.287	•		•		83932877
 Claw grasping forceps Ø 5 mm bndl double-action	27 mm	8393.494	•	•			83934945

* JL = jaw length when jaw section closed (approximate measurements)
 HF connection cable: see sheet GYN114/115

ERAGON modular







Ø 5.0 MM, INSULATED







Jaw insert			Sheath tube, Ø 5.0 mm, insulated		Handle, pistol-shaped			Complete instrument • Jaw insert with sheath tube • Handle
			SL 330 mm	SL 450 mm	with lock, without HF	without lock, with HF, mono	with lock, with HF, mono	
	JL*	Product no.	8393933	8394933	83930072	83930073	83930074	Product no.
Myoma grasping forceps Ø 5 mm bndl  2x3-claw, single-action	29 mm	8393.488	•		•			83934887
Universal grasping forceps mono Ø 5 mm bndl  with pyramid-shaped toothing and cross toothing, double-action	18 mm	8393.481	•				•	83934817
Universal grasping forceps Ø 5 mm bndl  pyramid-shaped toothing and cross toothing, double-action	26 mm	8393.482	•		•			83934827
Grasping forceps mono Ø 5 mm bndl  Pike-mouth, double-action	20 mm	8393.483	•				•	83934837
Biopsy forceps mono Ø 5 mm bndl  with spikes, double-action	13 mm	8393.091	•				•	83930917
		8394.091		•			•	83940917
Biopsy forceps mono Ø 5 mm bndl  severing, single-action	14 mm	8393.092	•				•	83930927
		8394.092		•			•	83940927

* JL = jaw length when jaw section closed (approximate measurements)

HF connection cable: see sheet GYN114/115

ERAGON modular
Ø 5.0 MM, INSULATED

		Handle, axial			
 All jaw inserts and sheath tubes can also be combined with ERAGONaxial					
		with lock	without lock, with HF connector	without lock, with HF connector	with lock, not rotatable
Rotatable knob	Product no.	83930082	83930083	83930084	83930085
	8988	•	•	•	







Jaw insert			Sheath tube, Ø 5.0 mm, insulated		Handle, pistol-shaped		Complete instrument • Jaw insert with sheath tube • Handle
							
	JL*	Product no.	SL 330 mm	SL 450 mm	with lock, without HF	without lock, with HF, mono	Product no.
 Biopsy forceps mono Ø 5 mm bndl pointed spoon forceps, single-action	20 mm	8393.093	•			•	83930937
 Knot pusher Ø 5 mm bndl with distal recess, double-action	17 mm	8393.345	•		•		83933457
		8394.345		•		•	
 Grasping forceps Ø 5 mm bndl spring jaw sections fenestrated with cross toothing, double-action	37 mm	8393.188	•		•		83931887
 Grasping forceps Ø 5 mm bndl spring jaw sections fenestrated with cross toothing, double-action	47 mm	8393.189	•		•		83931897
		8394.189		•		•	

* JL = jaw length when jaw section closed (approximate measurements)

HF connection cable: see sheet GYN114/115

ERAGON modular







Ø 5.0 MM, INSULATED







Jaw insert			Sheath tube, Ø 5.0 mm, insulated		Handle, pistol-shaped		Complete instrument • Jaw insert with sheath tube • Handle
			SL 330 mm	SL450 mm	with lock, without HF	with lock, with HF, mono	
	JL*	Product no.	8393933	8394933	83930072	83930074	Product no.
 Debaquey forceps Ø 5 mm bndl atraumatic, spring jaw sections with cross toothing, double-action	47 mm	8393.291	•		•		83932917
 Dissector forceps mono Ø 5 mm bndl angled, double-action	18 mm	8393192	•			•	83931927
		8394192		•		•	83941927
 Grasping forceps, mono Ø 5 mm bndl double-action	16 mm	8393193	•		•		83931937
		8394193		•	•		83941937
 Dissector forceps mono Ø 5 mm bndl double-action	24 mm	8393194	•			•	83931947
		8394194		•		•	83941947
 Dissector forceps mono Ø 5 mm bndl double-action	30 mm	8393197	•			•	83931977
		8394197		•		•	83941977
 Dissector forceps mono Ø 5 mm bndl fine tips double-action	33 mm	8393198	•			•	83931987
		8394198		•		•	83941987

* JL = jaw length when jaw section closed (approximate measurements)

HF connection cable: see sheet GYN114/115

ERAGON modular
Ø 5.0 MM, INSULATED







		Handle, axial			
 All jaw inserts and sheath tubes can also be combined with ERAGONaxial					
		with lock	without lock, with HF connector	without lock, with HF connector	with lock, not rotatable
Rotatable knob	Product no.	83930082	83930083	83930084	83930085
	8988	•	•	•	

Jaw insert		Sheath tube, Ø 5.0 mm, insulated		Handle, pistol-shaped	Complete instrument	
					• Jaw insert with sheath tube • Handle	
		SL 330 mm	SL 450 mm	with lock, with HF, mono		
	JL*	Product no.	8393933	8394933	83930074	Product no.
 32 mm double-action		8393199	•		•	83931997
		8394199		•		•
 19 mm fine tip, double-action		8393200	•		•	83932007
		8394200		•		•
 16 mm atraumatic, with cross toothing, double-action		8393210	•		•	83932107
 19mm atraumatic, with cross toothing, double-action		8393220	•		•	83932207
		8394220		•		•

* JL = jaw length when jaw section closed (approximate measurements)
 HF connection cable: see sheet GYN114/115

ERAGON modular







Ø 5.0 MM, INSULATED







Jaw insert			Sheath tube, Ø 5.0 mm, insulated		Handle, pistol-shaped		Complete instrument • Jaw insert with sheath tube • Handle
			SL 330 mm	SL 450 mm	with lock, without HF	with lock, with HF, mono	
			Product no.:	8393933	8394933	83930072	83930074
 Atraumatic grasping forceps Ø 5 mm bndl atraumatic, with pyramid-shaped toothings and cross toothings, double-action	29 mm	8393223	•		•		83932237
		8394223		•			83942237
 Atraumatic grasping forceps Ø 5 mm bndl atraumatic, single fenestrated with cross toothings, double-action	25 mm	8393250	•		•		83932507
		8394250		•		•	83942507
 Atraumatic grasping forceps Ø 5 mm bndl atraumatic, double fenestrated and curved single-action	32 mm	8393229	•		•		83932297
		8394229		•		•	83942297
 Grasping forceps Ø 5 mm bndl atraumatic, narrow and rounded, double-action	15 mm	8393230	•		•		83932307
		8394230		•		•	83942307
 Dissector forceps mono Ø 5 mm bndl curved, double-action	19 mm	8393240	•			•	83932407
		8394240		•		•	83942407
 Dissector forceps mono Ø 5 mm bndl single fenestrated double-action	17 mm	8393242	•		•		83932427
		8394242		•		•	83942427

* JL = jaw length when jaw section closed (approximate measurements)

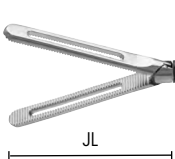
HF connection cable: see sheet GYN114/115

ERAGON^{modular}
 Ø 5.0 MM, INSULATED









		Handle, axial			
 All jaw inserts and sheath tubes can also be combined with ERAGONaxial					
		with lock	without lock, with HF connector	without lock, with HF connector	with lock, not rotatable
Rotatable knob	Product no.	83930082	83930083	83930084	83930085
	8988	•	•	•	

Jaw insert		Sheath tube, Ø 5.0 mm, insulated		Handle, pistol-shaped		Complete instrument • Jaw insert with sheath tube • Handle	
							
	JL*	Product no.	SL 330 mm	SL 450 mm	with lock, without HF	with lock, with HF, mono	Product no.
 Intestine grasping forceps Ø 5 mm bndl atraumatic, single fenestrated with cross tooting, double-action	38 mm	8393249	•		•		83932497
		8394249		•	•		83942497
 Debakey forceps mono Ø 5 mm bndl curved, double-action	35 mm	8393256	•			•	83932567
	 Debakey forceps mono Ø 5 mm bndl double-action	47 mm	8393258	•			•
		8394258		•		•	83942587

* JL = jaw length when jaw section closed (approximate measurements)
 HF connection cable: see sheet GYN114/115

ERAGON modular







Ø 5.0 MM, INSULATED







Jaw insert			Sheath tube, Ø 5.0 mm, insulated		Handle, pistol-shaped	Complete instrument • Jaw insert with sheath tube • Handle
						without lock, with HF, mono
			SL 330 mm	SL 450 mm		
	JL*	Product no.	8393933	8394933	83930073	Product no.
 Metzenbaum scissors mono Ø 5 mm bndl	23 mm	8393.041	•		•	83930417
		8394.041		•		83940417
 Metzenbaum micro scissors mono Ø 5 mm bndl	18 mm	8393.044	•		•	83930447
 Scissors mono Ø 5 mm bndl	20 mm	8393.045	•		•	83930457
 Hook scissors mono Ø 5 mm bndl	14 mm	8393.081	•		•	83930817
		8394.081		•		83940817
 Metzenbaum micro scissors mono Ø 5 mm bndl	21 mm	8393243	•		•	83932437
		8394243		•		83942437
 Scissors mono Ø 5 mm bndl	26 mm	8393246	•		•	83932467
		8394246		•		83942467

* JL = jaw length when jaw section closed (approximate measurements)

HF connection cable: see sheet GYN114/115

ERAGON^{modular}
 Ø 5.0 MM, INSULATED

		Handle, axial			
 All jaw inserts and sheath tubes can also be combined with ERAGONaxial					
		with lock	without lock, with HF connector	without lock, with HF connector	with lock, not rotatable
Rotatable knob	Product no.	83930082	83930083	83930084	83930085
	8988	•	•	•	



Jaw insert		Sheath tube, Ø 5.0 mm, insulated		Handle, pistol-shaped		Complete instrument • Jaw insert with sheath tube • Handle
						
	JL*	SL 330 mm	SL 450 mm	with lock, without HF	without lock, with HF, mono	
	Product no.	8393933	8394933	83930072	83930073	Product no.
 Scissors mono Ø 5 mm bndl	22 mm	8393248	•		•	83932487
fine-toothed, fine tip double-action		8394248	•		•	83942487
 Knot pusher Ø 5 mm bndl	17 mm	8393.345	•	•		83933457
with distal recess, double-action		8394345	•	•		83943457
 Gastric band manipulator Ø 5 mm bndl	47 mm	8393253	•	•		83932537
90° articulating with distal slot		8394253	•	•		83942537

* JL = jaw length when jaw section closed (approximate measurements)

HF connection cable: see sheet GYN114/115

Accessories for manual and machine reprocessing	Product no.
 Irrigation adapter Ø 9 mm, length 64 mm	163502

ERAGON^{modu} blades
 Ø 5.0 MM, INSULATED

		Handle, axial
 All jaw inserts and sheath tubes can also be combined with ERAGONaxial		 without lock, with HF connector
Rotatable knob	Product no.	83930083
	8988	.



Scissors attachment	Tension rod Ø 5.0 mm			Sheath tube insulated Ø 5.0 mm			Handle pistol-shaped	Complete instrument	
								• Jaw insert with sheath tube • Handle	
	for SL 260 mm	for SL 330 mm	for SL 450 mm	SL 240 mm	SL 310 mm	SL 430 mm	without lock, rotatable with HF connector		
	Product no.	8392934	8393934	8394934	8392935	8393935	8394935	83930073	Product no.
Metzenbaum scissors attachment mono	83920407
 (PACK= 10 PCS), sterile, disposable	4393040	83930407
		83940407









HF connection cable: see sheet GYN114/115

||24|| Subject to modifications. Please note that some products may not be available in all countries. Please always take note of the information that is provided with the product. For more detailed information, please consult with your contact partner or directly with Richard Wolf GmbH.

ERAGON^{modular}
 Ø 10 MM, UNINSULATED

		Handle, axial	
ERAGON^{axial}			
All jaw inserts and sheath tubes can also be combined with ERAGON^{axial}		with lock, without HF connector	with lock, without HF connector, not rotatable
Rotatable knob	Product no.	83930082	83930085
	8988	.	.

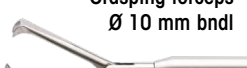
Jaw insert		Sheath tube, Ø 10.0 mm, uninsulated		Handle, pistol-shaped	Complete instrument	
					<ul style="list-style-type: none"> • Jaw insert with sheath tube • Handle 	
	JL*	Product no.	SL 327 mm	SL 447 mm	with lock, without HF	Product no.
	36 mm	8395.225	.	.	.	83952257
double-action		8396225	.	.	.	83962257
	35 mm	8395.226	.	.	.	83952268
angled, double-action		8396226	.	.	.	83962267
	20 mm	8395.236	.	.	.	83952368
Pike-mouth double-action		8396236	.	.	.	83962367
	49 mm	8395.204	.	.	.	83952048
2/3 jaws single-action		8396204	.	.	.	83962047







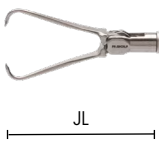

* JL = jaw length when jaw section closed (approximate measurements)

HF connection cable: see sheet GYN114/115

|| Subject to modifications. Please note that some products may not be available in all countries. Please always take note of the information that is provided with the product. For more detailed information, please consult with your contact partner or directly with Richard Wolf GmbH.





ERAGON modular



Ø 10 MM, UNINSULATED



Jaw insert			Sheath tube, Ø 10.0 mm, uninsulated			Handle, pistol-shaped		Complete instrument • Jaw insert with sheath tube • Handle
			SL 327 mm	SL 447 mm	SL 387 mm	with lock, without HF		
	JL*	Product no.	8395902	8396902	8397902	83930072	83930082	Product no.
 Claw grasping forceps Ø 10 mm bndl double-action	38 mm	8395.489	•			•		83954897
 Claw grasping forceps Ø 10 mm bndl with additional row of teeth, double-action	38 mm	8395490	•			•		83954907
 Babcock forceps Ø 10 mm bndl large distal gripping surface with fine cross toothing, double-action	42 mm	8395.187	•			•		83951877
		8396187		•		•		83961877
 Babcock forceps Ø 10 mm bndl double-action	38 mm	8395.214	•			•		83952148
 Plate-shaped grasping forceps Ø 10 mm bndl double-action	50 mm	8395.234	•			•		83952347
		8396234		•		•		83962347
 Spoon forceps Ø 10 mm bndl single-action	31 mm	8395.244	•			•		83952448
 Stapler head grasping forceps Ø 10 mm bndl angled 30°, double-action		8397.655			•		•	83976558

* JL = jaw length when jaw section closed (approximate measurements)/HF connection cable: see sheet GYN114/115

ERAGON modular
ACCESSORIES

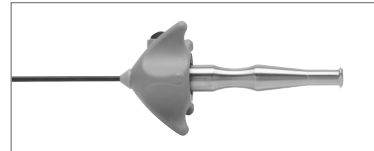
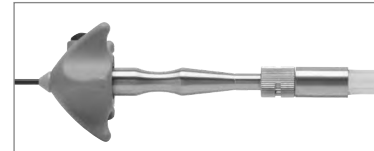
For insulated sheath tubes		Product no.
	For manual and machine reprocessing: Irrigation adapter Ø 9 mm, length 64 mm for insulated sheath tubes	163502
		



For uninsulated sheath tubes		Product no.
	For manual and machine reprocessing: Irrigation adapter cleaning Ø 9 mm, length 64 mm for uninsulated sheath tubes	163503
		



		8393932
		8394932

		Ø	SL	Product no.
ERAGONmodular	Sheath tube insulated Ø 5 mm SL 330 mm with distal cm scale	5 mm	330 mm	8393932
	Sheath tube insulated Ø 5 mm SL 450 mm with distal cm scale	5 mm	450 mm	8394932

1124|| Subject to modifications. Please note that some products may not be available in all countries. Please always take note of the information that is provided with the product. For more detailed information, please consult with your contact partner or directly with Richard Wolf GmbH.

HANDLE VARIANTS FOR MODULAR SYSTEMS

Handle, pistol-shaped ERAGON _{modular}	rotatable	with lock	without lock	with HF	without HF	Product no.
	•	•			•	83930072
	•		•	•		83930073
	•	•		•		83930074

Handle, axial ERAGON _{axial}	rotatable	with lock	without lock	with HF	without HF	Product no.
	•	•			•	83930082
	•		•	•		83930083
	•	•		•		83930084
		•			•	83930085

Optional for 83930082/83930083/83930084:		Product no.
	Rotatable knob autoclavable	8988

All **ERAGON**_{modular} components are compatible with **ERAGON**_{axial}





BIPOLAR FORCEPS 3.5 MM/5.0 MM



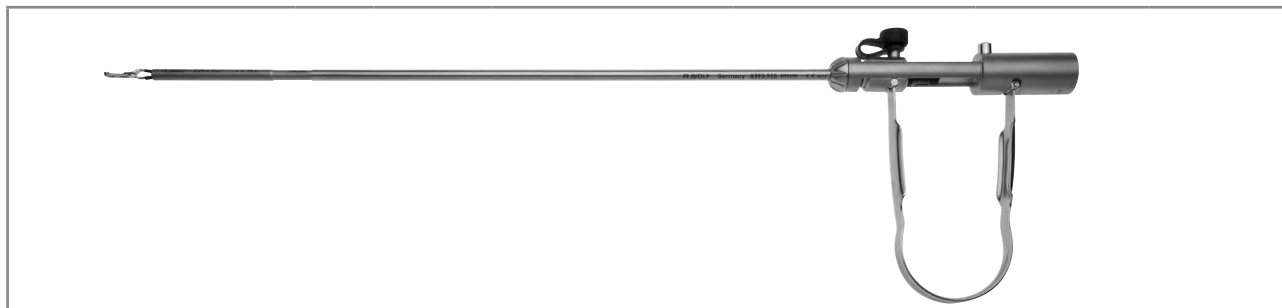

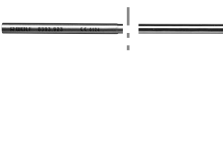
WITH SPRING HANDLE
MODULAR SYSTEM

BIPOLAR FORCEPS

6

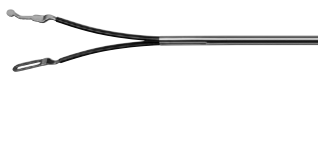

Grasping forceps jaw insert			Outer tube Ø 3.5 mm SL 348 mm	Screw cap with sleeve Ø 5.0 mm SL 107 mm	Spring handle bipo	complete instrument • Jaw insert • Sliding sleeve • Outer tube • Spring handle
						
	JL*	Product no.	8391.921	8393.978	8393.975	Product no.
	39 mm	8391.715	•	•	•	8391.742





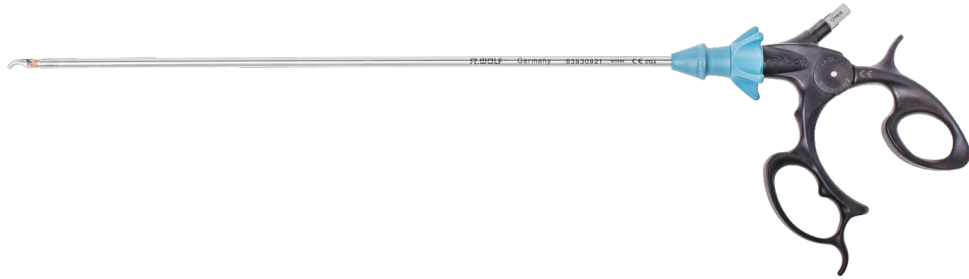

Kleppinger grasping forceps jaw insert			Sliding sleeve SL 319 mm	Outer tube Ø 5 mm SL 237 mm	Spring handle bipo	complete instrument • Jaw insert • Sliding sleeve • Outer tube • Spring handle
						
	JL*	Product no.	8393.923	8393.925	8393.975	Product no.
	53 mm	8393.714	•	•	•	8393.741

Accessories	Product no.
RIWO rubber cap, jet black	15220.019
Luer sealing cap	15023.153

* JL = jaw length when jaw section closed (approximate measurements)
Bipolar connection cable: see sheet GYN116/117

ERAGON bipolar
MODULAR BIPOLAR INSTRUMENTS, 5.5 MM
ROTATABLE







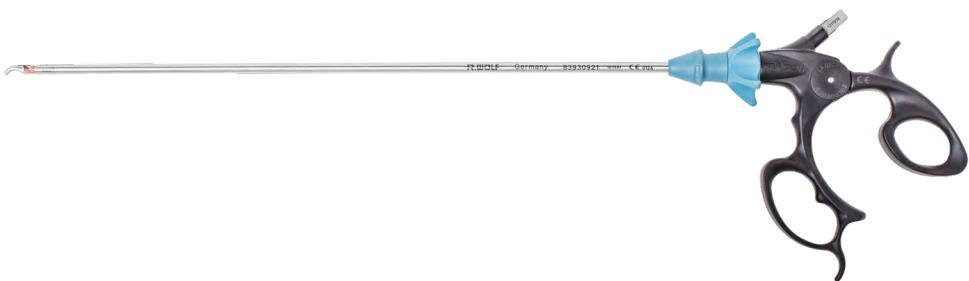

Jaw insert		Sheath tube Ø 5.5 mm		Handle, pistol-shaped, bipo	Complete instrument <ul style="list-style-type: none"> • Jaw insert • Sheath tube • Handle 	
		SL 320 mm	SL 435 mm	 rotatable		
	JL*	Product no.	83930921	82340024	839300102	Product no.
	21 mm	83930031	•		•	839300312
		839400310			•	839400312
	23 mm	83930032	•		•	839300322
		839400320			•	839400322
	21 mm	83930033	•		•	839300332
		839400330			•	839400332
	23 mm	83930034	•		•	839300342
		839400340			•	839400342
	19 mm	83930035	•		•	839300352
		839400350			•	839400352

* JL = jaw length when jaw section closed (approximate measurements)
 Bipolar connection cable: see sheet GYN116/117

||24|| Subject to modifications. Please note that some products may not be available in all countries. Please always take note of the information that is provided with the product. For more detailed information, please consult with your contact partner or directly with Richard Wolf GmbH.

ERAGON bipolar
MODULAR BIPOLAR INSTRUMENTS, 5.5 MM,
ROTATABLE

							
Jaw insert			Sheath tube Ø 5.5 mm		Handle, pistol-shaped, bipo		Complete instrument • Jaw insert • Sheath tube • Handle
							
			SL 320 mm	SL 435 mm	rotatable		
	JL*	Product no.	83930921	82340024	839300102	Product no.	
	22 mm	83930037	•		•	839300372	
	15 mm	83930038	•		•	839300382	
		839400380		•	•	839400382	
	22 mm	83930041	•		•	839300412	
		839400410		•	•	839400412	

* JL = jaw length when jaw section closed (approximate measurements)
Bipolar connection cable: see sheet GYN116/117





ELECTRODES 2.0 MM/3.5 MM

MONOPOLAR



		Outer Ø	WL	Product no.
	Coagulation electrode mono 5 Fr WL 400 mm	1.67 mm	400 mm	823.05
	Coagulation electrode mono 6 Fr WL 400 mm	2.0 mm	400 mm	823.06



		Outer Ø	WL	Product no.
	Hook electrode mono Ø 3.5 mm WL 310 mm	3.5 mm	310 mm	8379.452
	Hook electrode mono Ø 3.5 mm WL 240 mm with distally extended insulation	3.5 mm	240 mm	8785.642
	Needle electrode mono Ø 3.5 mm WL 310 mm	3.5 mm	310 mm	8379.482
	Coagulation electrode mono Ø 3.5 mm WL 310 mm	3.5 mm	310 mm	8379.462

HF connection cable: see sheet GYN114/115





ELECTRODES 5.0 MM

MONOPOLAR



		Outer Ø	WL	Product no.
	Coagulation electrode mono Ø 5 mm WL 330 mm	5.0 mm	330 mm	8383.40
	Coagulation electrode mono Ø 5 mm WL 450 mm	5.0 mm	450 mm	8384.40



		Outer Ø	WL	Product no.
	Hook electrode mono Ø 5 mm WL 340 mm	5.0 mm	340 mm	8383.423
	Hook electrode mono Ø 5 mm WL 420 mm		420 mm	8384.423
	Needle electrode mono Ø 5 mm WL 340 mm	5.0 mm	340 mm	8383.426
	Spatula electrode mono Ø 5 mm WL 340 mm	5.0 mm	340 mm	8383.428
	Myoma dissector mono Ø 5 mm WL 340 mm	5.0 mm	340 mm	8383429

HF connection cable: see sheet GYN114/115

MULTIFUNCTIONAL SUCTION IRRIGATION SYSTEM

COMBINATION OPTIONS

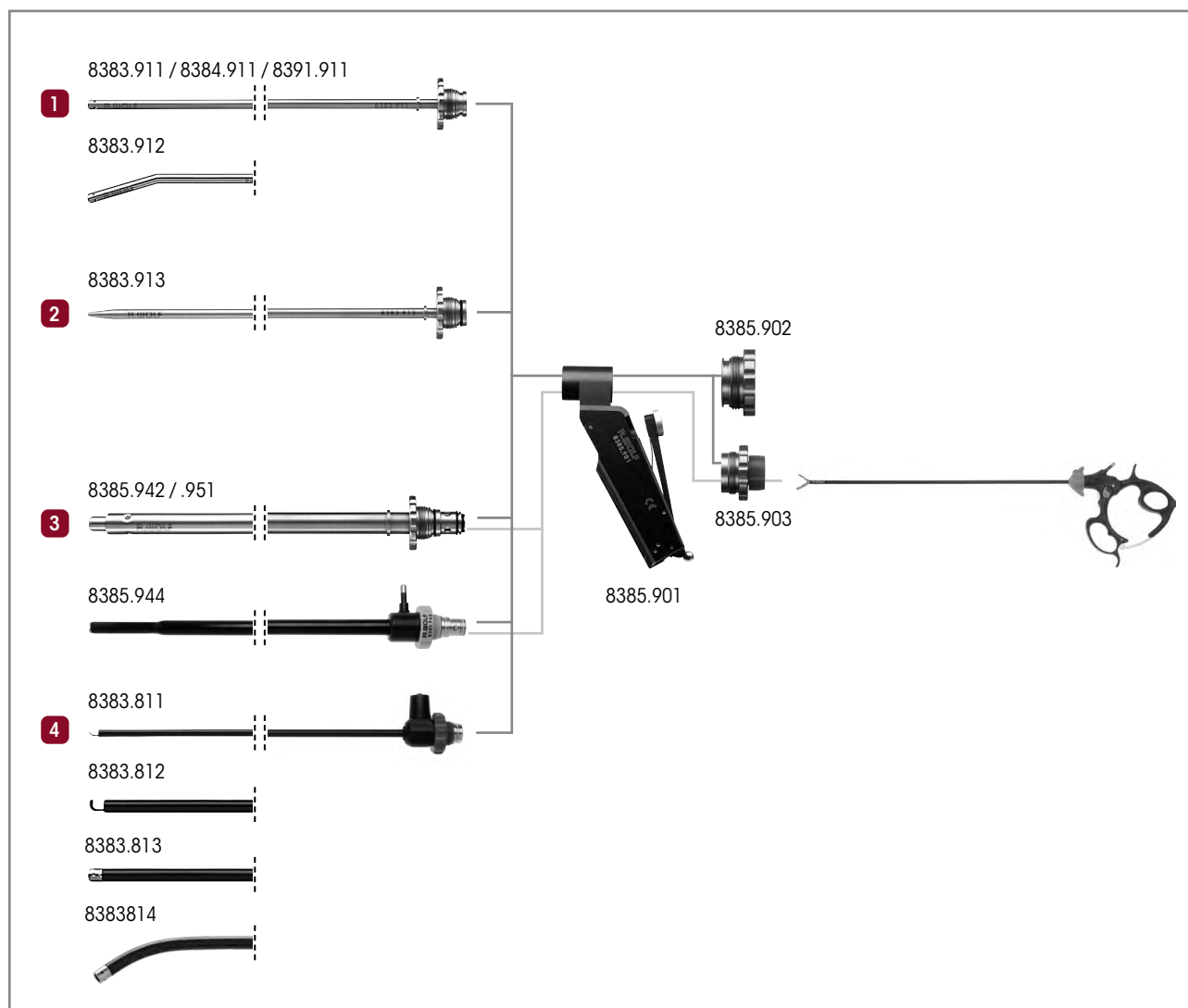

1 Suction or irrigation:

- Suction irrigation tube Ø 5 mm WL 310 mm 8383.911
- Suction irrigation tube Ø 5 mm WL 450 mm 8384.911
- Suction irrigation tube Ø 3.5 mm WL 300 mm 8391.911
- Suction irrigation tube curved Ø 5 mm WL 310 mm... 8383.912
- for this: **Sealing cap** 8385.902

2 Blunt aquadissection:

- Pressure irrigation tube Ø 5 mm WL 310 mm 8383.913
- for this: **Sealing cap** 8385.902

3 Suction, irrigation, and use of auxiliary instruments Ø 5 mm:

- Suction irrigation tube Ø 10 mm WL 225 mm 8385.942
- Suction irrigation tube Ø 10 mm WL 330 mm 8385.951
- Suction irrigation tube Ø mono 10 mm WL 330 mm, insulated, with atraumatic preparation tip 8385.944
- for this: **Sealing adapter** 8385.903

4 Preparation of tissue with HF:

- HF suction irrigation tube Ø 5.2 mm WL 317 mm insulated with integrated HF spatula probe 8383.811
- HF suction irrigation tube Ø 5.2 mm WL 317 mm insulated with integrated HF hook electrode 8383.812
- HF suction irrigation tube Ø 5.2 mm WL 317 mm insulated with integrated HF button electrode 8383.813
- HF suction irrigation tube Ø 5.4 mm WL 380 mm curved with distal openings, insulated with integrated HF button electrode 8383.814
- for this: **Sealing cap** 8385.902

1124|| Subject to modifications. Please note that some products may not be available in all countries. Please always take note of the information that is provided with the product. For more detailed information, please consult with your contact partner or directly with Richard Wolf GmbH.

MULTIFUNCTIONAL SUCTION IRRIGATION SYSTEM

SUCTION IRRIGATION HANDLE

 <p>8385.901</p> <p>AUTOCLAVE 134° C / 273° F</p> <p>8385.902</p> <p>8385.903</p>	
Product no.	
Suction irrigation handle	8385.901
Sealing cap	8385.902
Required to use auxiliary instruments Ø 5 mm: Sealing attachment with opening and membrane valve	8385.903
Spare Sealing membrane Ø 17 mm yellow, Ø 17 mm, PACK= 10 PCS, for instruments from 3 to 6 mm	89.103

MULTIFUNCTIONAL SUCTION IRRIGATION SYSTEM

SUCTION IRRIGATION TUBE SETS – ILLUSTRATION

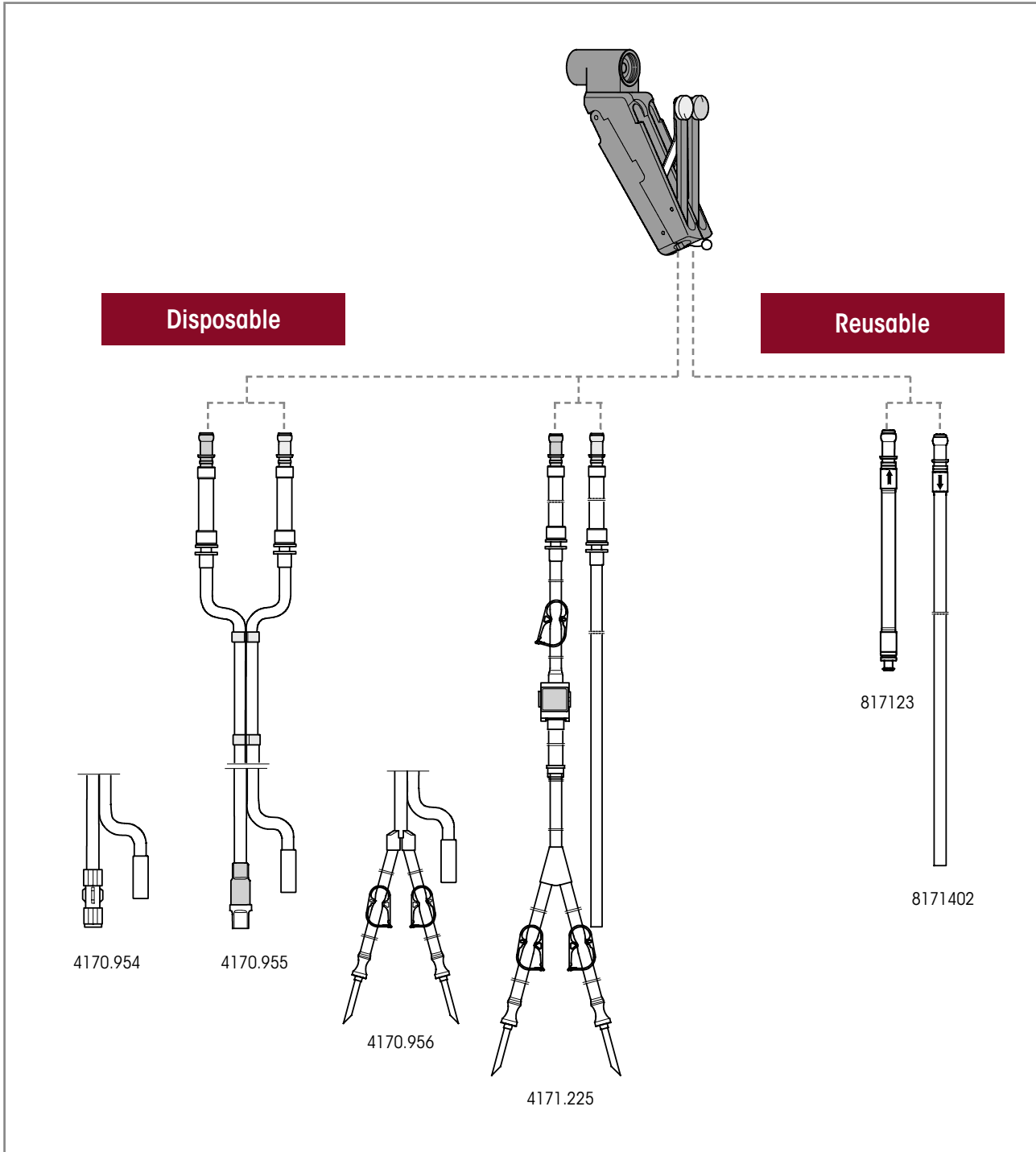

Suction irrigation tube sets are used in conjunction with the suction irrigation handle 8385.901 and pump-side tube systems as well as corresponding collection and secretion containers and/or vacuum pumps.

MULTIFUNCTIONAL SUCTION IRRIGATION SYSTEM





SUCTION IRRIGATION TUBE SETS FOR SUCTION IRRIGATION HANDLE 8385.901

Disposable		Product no.
Suction irrigation tube set, L 3 m (PACK= 10 PCS), sterile	Irrigation tube: With Luer-Lock, for connection to the irrigation tube of a suction irrigation tube set, e.g., irrigation tube of the Endo-Irrigator 2211 Suction tube: For connection to a collection or secretion container and/or vacuum pump	4170.954
Suction irrigation tube set with care-lock, L 3 m (PACK= 10 PCS), sterile	Irrigation tube: With CARE-LOCK, for connection to an irrigation container Suction tube: For connection to a collection or secretion container and/or vacuum pump	4170.955
Suction irrigation tube set with piercing spike, L 3 m (PACK= 10 PCS), sterile	Irrigation tube: With 2 piercing spikes, for connection to an irrigation container Suction tube: For connection to a collection or secretion container and/or vacuum pump	4170.956
Suction irrigation tube set, L 3 m (PACK= 10 PCS), sterile	Irrigation tube: With 2 piercing spikes, for connection to an irrigation container, and Fluid Control Lap 2216 Suction tube: For connection to a collection or secretion container and/or vacuum pump Also observe instruction manual GA-A 276	4171.225
Secretion container, 2.5 l	2.5 liters	41706566
Tube set for suction (2 connections)	sterile disposable product (PACK= 10 PCS), for connecting instruments to collecting container	T0503-01



Reusable		Product no.
Irrigation tube L 1.2 m	Irrigation tube: With Luer-Lockconnection for connection to the irrigation tube of a suction irrigation tube set, e.g., 8171223 or 8170.223	817123
Suction tube L 3 m	silicone, for suction irrigation handle 8385.901	8171402
Secretion container, 2 l	2 liters, without cover	8170.6551
Cover	for secretion trap 8170.6551, reusable	8170.6552



MULTIFUNCTIONAL SUCTION IRRIGATION SYSTEM

SUCTION IRRIGATION TUBES

		Outer Ø	WL	Product no.
				
	Suction irrigation tube Ø 3.5 mm WL 300 mm	3.5 mm	300 mm	8391.911
	Suction irrigation tube Ø 5 mm WL 310 mm	5.0 mm	310 mm	8383.911
	Suction irrigation tube Ø 5 mm WL 450 mm	5.0 mm	450 mm	8384.911
	Suction irrigation tube curved Ø 5 mm WL 310 mm	5.0 mm	310 mm	8383.912
	Pressure irrigation tube Ø 5 mm WL 310 mm	5.0 mm	310 mm	8383.913

Zur Anwendung von 5 mm Hilfsinstrumenten

		Outer Ø	WL	Product no.
				
 Durchlass 5,0 mm	Suction irrigation tube Ø 10 mm WL 225 mm	10.0 mm	225 mm	8385.942
	Suction irrigation tube Ø 10 mm WL 330 mm	10.0 mm	330 mm	8385.951

		Outer Ø	WL	Product no.
				
 isoliert, mit atraumatischer Präparierspitze	Saug-Spül-Rohr mono Ø 10 mm NL 330 mm	10,0 mm	330 mm	8385.944





for use of 5 mm auxiliary instruments		Product no.		
	Dichtaufsatz mit Durchgang und Membranventil Dichtmembrane Ø 17 mm	8385.903		

MULTIFUNCTIONAL SUCTION IRRIGATION SYSTEM

SUCTION IRRIGATION TUBES

MULTIFUNCTIONAL SUCTION IRRIGATION SYSTEM

9

					
		Outer Ø	WL	Product no.	
	insulated with integrated HF spatula probe	HF suction irrigation tube Ø 5.2 mm WL 317 mm	5.2 mm	317 mm	8383.811
	insulated with integrated HF hook probe	HF suction irrigation tube Ø 5.2 mm WL 317 mm	5.2 mm	317 mm	8383.812
	insulated with integrated HF button electrode	HF suction irrigation tube Ø 5.2 mm WL 317 mm	5.2 mm	317 mm	8383.813
as alternative to suction irrigation handle:					
		Suction irrigation adapter with maintenance-free two-way stopcock, for multifunctional suction irrigation system			8583819

Accessories	Product no.
HF connection cable	see page GYN114/115

MULTIFUNCTIONAL SUCTION IRRIGATION SYSTEM

SUCTION IRRIGATION TUBES



		Outer Ø	WL	Product no.
	Suction tube OD 2.8 mm WL 450 mm	2.8 mm	450 mm	8380.68



		Outer Ø	WL	Product no.
 with Luer connector	Suction irrigation tube Ø 3 mm WL 300 mm	3.0 mm	330 mm	8383.72



		Outer Ø	WL	Product no.
 graduated, with 3 mm Luer connector	Suction tube graduated Ø 5 mm WL 330 mm	5.0 mm	330 mm	8383.68

1124|| Subject to modifications. Please note that some products may not be available in all countries. Please always take note of the information that is provided with the product. For more detailed information, please consult with your contact partner or directly with Richard Wolf GmbH.

ACCESSORIES FOR SUCTION AND IRRIGATION



		Outer Ø	WL	Product no.
 with Luer connector and a valve	HF coagulation suction tube mono Ø 5 mm WL 315 mm	5.0 mm	315 mm	8383.71
	HF coagulation suction tube mono Ø 5 mm WL 450 mm	5.0 mm	450 mm	8384.71



		Outer Ø	WL	Product no.
 with stop valve	Suction irrigation tube Ø 5 mm WL 300 mm	5.0 mm	300 mm	8383.94

Accessories	Product no.
HF connection cable	See page BDE116/117

ACCESSORIES FOR SUCTION AND IRRIGATION

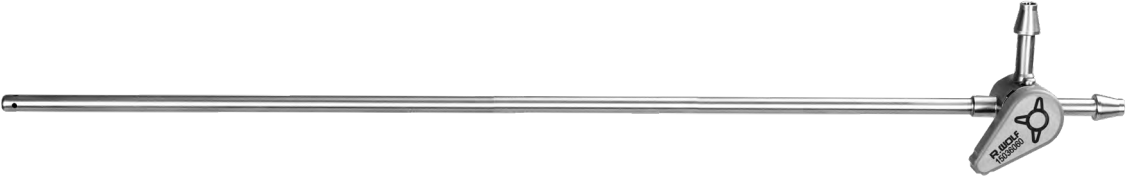

		Outer Ø	WL	Product no.
 with maintenance-free two-way stopcock, sheath tube, with distal openings, reusable	Suction irrigation tube WL 290 mm	5.0 mm	290 mm	8583732
	Suction irrigation tube WL 410 mm	5.0 mm	410 mm	8584732

TISSUE RETRACTOR 5 MM

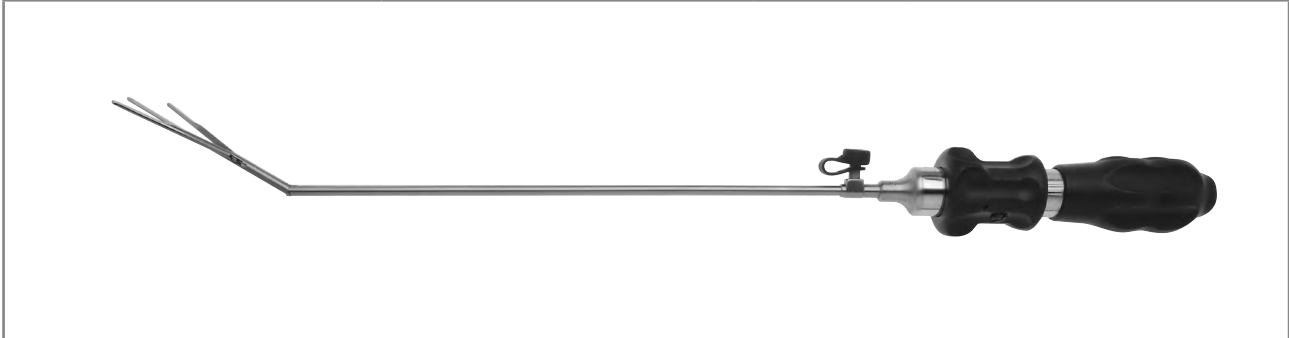

		Outer Ø	WL	Product no.
	tissue retractor Ø 5 mm WL 320 mm	5.0 mm	320 mm	8383.691



Accessories	Product no.
Luer sealing cap	887.00

1124 | Subject to modifications. Please note that some products may not be available in all countries. Please always take note of the information that is provided with the product. For more detailed information, please consult with your contact partner or directly with Richard Wolf GmbH.

CLIP APPLICATOR 10 MM

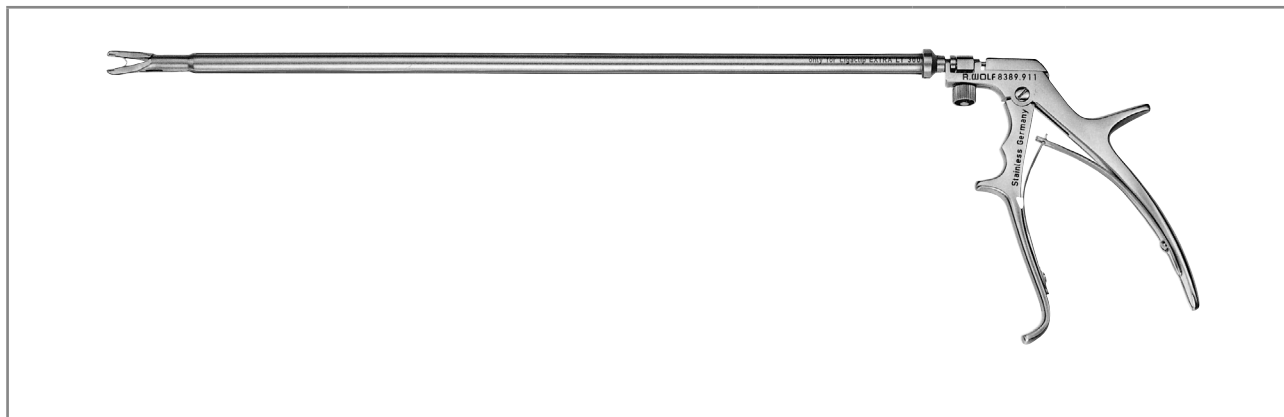
FOR SUCTION AND IRRIGATION



		Outer Ø	WL	Product no.
	Clip applicator Ø 10 mm WL 340 mm	10 mm	340 mm	8389.911
for this:				Product no.
	Introduction sleeve 10 mm WL 80 mm with sealing cap			8389.991
For clip ligation with Ethicon® Ligaclip® EXTRA LT 300				
Ethicon® Ligaclips® (PACK= 108 PCS)				8389.915

Accessories	Product no.
Sealing cap capacity 9.5–10.1 mm	89.08

ERAGON^{stitch}

THE ERGONOMIC GENERATION OF NEEDLE HOLDERS

Thanks to the custom combination options it offers, **ERAGON^{stitch}** can accommodate any user requirement. The way in which it brings together ergonomics, versatility, modularity, and precision sets new standards in comfort

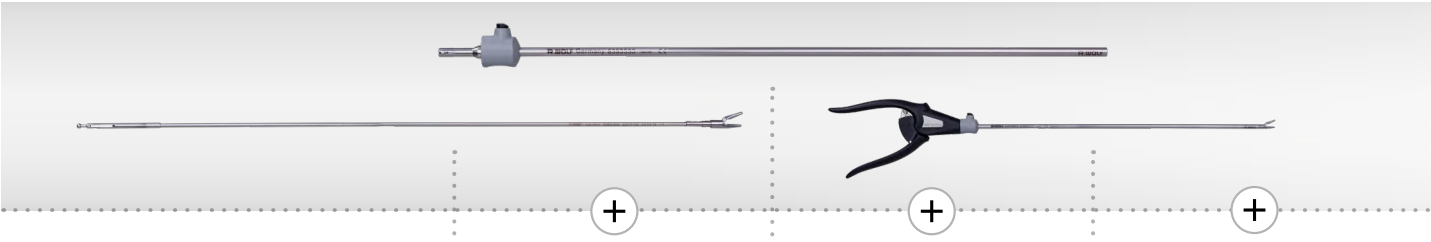

Choose working length Choose jaw insert Choose sheath tube Choose handle

Needle Diameter (∅)	Working Length Options	Jaw Insert Options	Sheath Tube Options	Handle Options
5.0 mm	330 mm 450 mm	5 different designs	1 design	1 design
3.5 mm	240 mm 330 mm	1 design	1 design	1 design

ERAGONSTITCH NEEDLE HOLDER





12

ERAGONstitch needle holders



ERAGON^{stitch}
NEEDLE HOLDER Ø 3.5 MM



Needle holder jaw insert			Sheath tube, Ø 3.5 mm		Needle holder handle		Complete instrument • Jaw insert • Sheath tube • Handle
							
							SL 240 mm
					Axial	Angled	
	JL*	Product no.	8390533	8391533	8393943	8393944	Product no.
	12 mm	8391505	•		•		83915053
			•		•		83915054
straight with carbide insert single-action		8391506		•	•		83915063
				•		•	83915064







* JL = jaw length when jaw section closed (approximate measurements)

Accessories for manual and machine reprocessing	Product no.
	Irrigation adapter cleaning Ø 9 mm, length 64 mm for uninsulated sheath tubes 163503

1124 | Subject to modifications. Please note that some products may not be available in all countries. Please always take note of the information that is provided with the product. For more detailed information, please consult with your contact partner or directly with Richard Wolf GmbH.

ERAGON^{stitch}





NEEDLE HOLDER Ø 5.0 MM

Needle holder jaw insert			Sheath tube, Ø 5.0 mm		Needle holder handle		Complete instrument • Jaw insert • Sheath tube • Handle	
								
	JL*	Product no.	8393533	8394533	8393943	8393944	Product no.	
 straight with carbide insert single-action	19 mm	Needle holder Ø 5 mm bndl	•		•		83935073	
			•			•	83935074	
				•		•		83945073
				•			•	83945074
 straight and narrow with carbide insert single-action	19 mm	Needle holder Ø 5 mm bndl	•		•		83935083	
			•			•	83935084	
				•		•		83945083
				•			•	83945084
 straight, with self-righting function single-action	19 mm	Needle holder jaw insert Ø 5 mm bndl	•		•		83935093	
			•			•	83935094	
				•		•		83945093
				•			•	83945094

* JL = jaw length when jaw section closed (approximate measurements)

Accessories for manual and machine reprocessing		Product no.
	Irrigation adapter cleaning Ø 9 mm, length 64 mm for uninsulated sheath tubes	163503

ERAGON *stitch*
NEEDLE HOLDER Ø 5.0 MM











Needle holder jaw insert			Sheath tube, Ø 5.0 mm		Needle holder handle		Complete instrument • Jaw insert • Sheath tube • Handle	
								
	JL*	Product no.	8393533	8394533	Axial	Angled	Product no.	
 Needle holder Ø 5 mm bndl	19 mm	8393518	•		•		83935183	
			•			•	83935184	
		8394518		•		•		83945183
				•		•		83945184
 Needle holder Ø 5 mm bndl	19 mm	8393519	•		•		83935193	
			•			•	83935194	
		8394519		•		•		83945193
				•		•		83945194

Accessories for manual and machine reprocessing		Product no.
	Irrigation adapter cleaning Ø 9 mm, length 64 mm for uninsulated sheath tubes	163503

1124 | Subject to modifications. Please note that some products may not be available in all countries. Please always take note of the information that is provided with the product. For more detailed information, please consult with your contact partner or directly with Richard Wolf GmbH.

NEEDLE HOLDER Ø 3.5 MM/5 MM

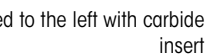
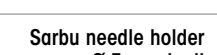

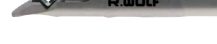
MODULAR SYSTEM

					
Needle holder jaw insert with sheath				Needle holder handle, axial	
					
				single-action locking mechanism, can be disabled	
	Product no.	Ø	SL	8393.941	Product no.
Needle holder Ø 3.5 mm bndl					
 with carbide insert					
Needle holder Ø 5 mm bndl					
 for straight needles					
Needle holder Ø 5 mm bndl					
 with carbide insert					
Needle holder Ø 5 mm bndl					
 curved to the right with carbide insert					
Needle holder Ø 5 mm bndl					
 curved to the right with carbide insert					
Needle holder Ø 5 mm bndl					
 curved to the left with carbide insert					
Needle holder Ø 5 mm bndl					
 curved to the left with carbide insert					
Needle holder Ø 5 mm bndl					
 curved to the left with carbide insert					
Sarbu needle holder Ø 5 mm bndl					
 with automatic needle placement apparatus and cutting edge					
Sarbu needle holder Ø 5 mm bndl					
 with automatic needle placement apparatus and cutting edge					

* with automatic needle placement apparatus and cutting edge

NEEDLE HOLDER HANDLE







Needle holder handle, axial	not rotatable	with lock	without HF	Product no.
	•	•	•	8393.941



Needle holder handle <small>ERAGON</small> <small>stitch</small>	axial	angled	with on-off detent mechanism	single-action	Not rotatable	Product no.
	•		•	•	•	8393943
		•	•	•	•	8393944

1124 | Subject to modifications. Please note that some products may not be available in all countries. Please always take note of the information that is provided with the product. For more detailed information, please consult with your contact partner or directly with Richard Wolf GmbH.

ERAGON_{modular}

MODULAR KNOT PUSHER Ø 5.0 MM, INSULATED

		Handle, axial			
 All jaw inserts and sheath tubes can also be combined with ERAGONaxial					
		with lock	without lock, with HF connector	without lock, with HF connector	with lock, not rotatable
Rotatable knob	Product no.	83930082	83930083	83930084	83930085
	8988	•	•	•	•



Jaw insert		Sheath tube, Ø 5.0 mm, insulated		Handle	Complete instrument • Jaw insert with sheath tube • Handle	
  JL		SL 330 mm	SL 450 mm	 with lock, without HF		
	JL*	Product no.	8393933	8394933	83930072	Product no.
Knot pusher Ø 5 mm bndl	17 mm	8393.345	•		•	83933457
with distal recess, double-action		8394345		•	•	83943457

* JL = jaw length when jaw section closed (approximate measurements)

HF connection cable: see sheet GYN114/115

KNOT PUSHER 5 MM FOR ENDOSCOPIC SUTURING



		Outer Ø	WL	TL	Product no.
	Knot pusher Ø 3.7 mm WL 330 mm	3.7 mm	330 mm	380 mm	8383.55
for intraabdominal knots					
	Knot pusher Ø 3.7 mm WL 330 mm	3.7 mm	330 mm	380 mm	8383.551
for extracorporeal knots					





		Outer Ø	WL	TL	Product no.
	Knot pusher Ø 5 mm WL 330 mm as per Bueß	5.0 mm	330 mm	380 mm	8383.552
with distal notch and lateral opening for optimum knotting, extremely atraumatic tip for use as a surgical probe					

1124 || Subject to modifications. Please note that some products may not be available in all countries. Please always take note of the information that is provided with the product. For more detailed information, please consult with your contact partner or directly with Richard Wolf GmbH.



ENDOSCOPICALLY CONTROLLED FASCIA CLOSURE SYSTEM



AS PER BUSCHE



		Product no.		
 for subcutaneous fascia suture	Sealing cone Ø 10–12 mm	8934.915		
	Sealing cone Ø 12–15 mm	8943.915		
	Sealing cone Ø 15–20 mm	8945.915		
		Ø	WL	Product no.
 Needle forceps with active suture holder	Needle forceps Ø 2.45 mm WL 160 mm	2.45 mm	160 mm	8756.201

CANNULAS 3.0 MM/4.7 MM

				
with Luer connector		Outer Ø	WL	Product no.
 Tip Ø 1.4 mm	Injection cannula Ø 3 mm WL 340 mm	3.0 mm	340 mm	8379.732

				
with 3 mm Luer connector		Ø	WL	Product no.
 Tip Ø 1.8 mm	Injection cannula Ø 4.7 mm WL 350 mm	4.7 mm	350 mm	8383.65

for this:		WL	Product no.
	Introduction sleeve size 5.5 mm WL 45 mm This sleeve prevents damage to the cannula tip when the trocar sleeve valve is opened	45 mm	8383.00

1124 || Subject to modifications. Please note that some products may not be available in all countries. Please always take note of the information that is provided with the product. For more detailed information, please consult with your contact partner or directly with Richard Wolf GmbH.

SURGICAL PROBES



		Ø	WL	Product no.
	Surgical probe 3.5 mm WL 350 mm graduated	3.5 mm	350 mm	8379.672



		Ø	WL	Product no.
	Surgical probe Ø 5 mm WL 328 mm graduated	5.0 mm	328 mm	8383.66
	Surgical probe Ø 5 mm WL 448 mm graduated	5.0 mm	448 mm	8384.66

||24|| Subject to modifications. Please note that some products may not be available in all countries. Please always take note of the information that is provided with the product. For more detailed information, please consult with your contact partner or directly with Richard Wolf GmbH.

MYOMA DRILL 5 MM/10 MM



		Ø	WL	Product no.
	Myoma drill Ø 5 mm WL 320 mm	5 mm	320 mm	8383.611
	Myoma drill Ø 10 mm	10 mm	340 mm	8385.301

INSUFFLATOR HIGHFLOW 45 BASIC



		Product no.
Insufflator 45 BASIC bndl consisting of: Insufflator 45 BASIC FR 45 l/min (2235001) and power cable 3 m long (2440.03)		22350012
Accessories: Tube sets for insufflation		
Insufflation set , insufflation tube with integrated hygiene filter, disposable, (PACK= 10 PCS) in individual sterile packaging		2200/48BIKBTUA123
Insufflation tube set L 2.5 m , High Flow, D = 8 mm, autoclavable		8170.232
Insufflation tube set L 2.5 m , autoclavable		8170.101
Hygiene filter , sterile, disposable (PACK= 10 PCS) in individual sterile packaging		4171.111
Accessories for gas supply CO₂ bottle		
Qualityreg CO₂ , Inlet pressure connection DIN ISO 477-6 outlet connection NIST, pressure gauge Flow meter	DIN ISO 477-6	DM-DIN6-MS-NISTCO2
Qualityreg CO₂ , Inlet connection DIN EN ISO 407 PIN INDEX, outlet connection NIST ,pressure gauge Flow meter	DIN EN ISO 407 PIN INDEX	DM-PIN-MS-NIST-CO2
Qualityreg CO₂ , Inlet connection ISO 5145 outlet connection NIST, pressure gauge Flow meter	ISO 5145	DM-ISO-MS-NIST-CO2
with		
Connection hose, quality CONNECT , CO ₂ 1.5 m long		DINCO2NIST-NIST1.5
Optional for faster CO₂ bottle changes		
Quick plug adapter NIST , (2 pieces recommended) DIN with safety chain, adapter NIST / coupling with chain and ring		DM-AD-CO2NISTDINKU
Connection hose DIN, CO₂ , ZGV plug to NIST fitting, ISO-colored, 1.5 m long (Ceiling light)		DIN-CO2-ZGVNIST1.5
ZGV connection		
Connection hose, quality CONNECT , CO ₂ 5 m long, DIN for centralized CO ₂ gas supply (Dräger)		RW-CO2-ZGV-NIST5.0
Connection hose, quality CONNECT , CO ₂ 5 m long, NF for centralized CO ₂ gas supply (Liquid Air)		NF-CO2-ZGV-NIST5.0
Connection hose DIN, CO₂ , ZGV plug to NIST fitting, ISO-colored, 1.5 m long (Ceiling light)		DIN-CO2-ZGVNIST1.5
Software modules (optional)		
Software module CAN bus CAN bus interface for integration in CORE		2235101
Software module BABY MODE BABY MODE for special use in pediatrics		2235102
Software module VIDEO DISPLAY : video display using DIALOG via CAN bus		2235103

TECHNICAL DATA

INSUFFLATOR HIGHFLOW 45 BASIC

Insufflator 45 BASIC		2235001
Device properties		
Operating mode	Continuous operation	
Operating conditions	+10°C to +40°C, 30% to 75% rel. humidity, atmospheric pressure 700 hPa to 1,060 hPa	
Storage and transport conditions	-20°C to +60°C, 10% to 90% rel. humidity, atmospheric pressure 700 hPa to 1,060 hPa	
Power supply		
Mains + frequency	100–240 V~, 50/60 Hz	
Power consumption	60 VA	
Current rating	0.6–0.2 A	
Fuse	T 3.15 AH 250 V	
Regulatory standards		
Protection class to IEC/EN 60601-1 (UL 60601-1/CSA C222 No6011 – for USA)	I	
Electromagnetic compatibility (EMC)	IEC/EN 60601-1-2	
Medical Devices Directive 93/42/EEC	Class IIb	
Protection against electric shock	Type CF applied part	
Degree of protection against the ingress of liquids	IP 20 (not protected)	
Degree of protection in the presence of flammable mixtures	Device is not protected against explosions (do not operate this device in explosive atmospheres)	
Dimensions and weights		
Weight	8.9 kg (19.5 lbs)	
Dimensions (W x H x D)	300 mm x 160 mm x 455 mm	

Relevant application parameters	
Insufflation medium	Medical-grade CO ₂ (degree of purity > 99.5%)
Intraabdominal pressure	3 mmHg to 25 mmHg (± 2 mmHg) selectable in increments of 1 mmHg
Gas flow rate primary filling	1 l/min (± 50%)
Gas flow rate, High Flow	2 l/min to 45 l/min (± 20%) selectable in increments of 1 l/min
Consumption indicator	0 l to 9,999 l (± 20%)

INSUFFLATOR HIGHFLOW 45 EVAC

WITH SMOKE GAS EVACUATION



		Product no.
Insufflator 45 EVAC bndI consisting of: Insufflator 45 EVAC FR 45 l/min (2235011), power cable, 3 m long (2440.03) and footswitch with 1 pedal (20301031)		22350112
Accessories: Tube sets for insufflation and smoke gas evacuation		
Insufflation set , insufflation tube with integrated hygiene filter, disposable, (PACK= 10 PCS) in individual sterile packaging		2200/48BIKBTUA123
Insufflation tube set L 2.5 m , High Flow, D = 8 mm, autoclavable		8170.232
Insufflation tube set L 2.5 m , autoclavable		8170.101
Hygiene filter , sterile, disposable (PACK= 10 PCS) in individual sterile packaging		4171.111
Smoke gas evacuation tube set , steril, sterile, for single use (PACK= 10 PCS)		2200/72BTUA1230001
Accessories for gas supply CO₂ bottle		
Qualityreg CO₂ , Inlet pressure connection DIN ISO 477-6 outlet connection NIST, pressure gauge Flow meter	DIN ISO 477-6	DM-DIN6-MS-NISTCO2
Qualityreg CO₂ , Inlet connection DIN EN ISO 407 PIN INDEX, outlet connection NIST, pressure gauge Flow meter	DIN EN ISO 407 PIN INDEX	DM-PIN-MS-NIST-CO2
Qualityreg CO₂ , Inlet connection ISO 5145 outlet connection NIST, pressure gauge Flow meter	ISO 5145	DM-ISO-MS-NIST-CO2
with		
Connection hose, quality CONNECT , CO ₂ 1.5 m long		DINCO2NIST-NIST1.5
Optional for faster CO₂ bottle changes		
Quick plug adapter NIST , (2 pieces recommended) DIN with safety chain, adapter NIST / coupling with chain and ring		DM-AD-CO2NISTDINKU
Connection hose DIN, CO₂ , ZGV plug to NIST fitting, ISO-colored, 1.5 m long (Ceiling light)		DIN-CO2-ZGVNIST1.5
ZGV connection		
Connection hose, quality CONNECT , CO ₂ 5 m long, DIN for centralized CO ₂ gas supply (Dräger)		RW-CO2-ZGV-NIST5.0
Connection hose, quality CONNECT , CO ₂ 5 m long, NF for centralized CO ₂ gas supply (Liquid Air)		NF-CO2-ZGV-NIST5.0
Connection hose DIN, CO₂ , ZGV plug to NIST fitting, ISO-colored, 1.5 m long (Ceiling light)		DIN-CO2-ZGVNIST1.5
Software modules (optional)		
Software module CAN bus CAN bus interface for integration in CORE		2235101
Software module BABY MODE BABY MODE for special use in pediatrics		2235102
Software module VIDEO DISPLAY : video display using DIALOG via CAN bus		2235103

TECHNICAL DATA

INSUFFLATOR HIGHFLOW 45 EVAC

Insufflator 45 EVAC		2235011
Device properties		
Operating mode	Continuous operation	
Operating conditions	+10°C to +40°C, 30% to 75% rel. humidity, atmospheric pressure 700 hPa to 1,060 hPa	
Storage and transport conditions	-20°C to +60°C, 10% to 90% rel. humidity, atmospheric pressure 700 hPa to 1,060 hPa	
Power supply		
Mains + frequency	100–240 V~, 50/60 Hz	
Power consumption	60 VA	
Current rating	0.6–0.2 A	
Fuse	T 3.15 AH 250 V	
Regulatory standards		
Protection class to IEC/EN 60601-1 (UL 60601-1/CSA C222 No6011 – for USA)	I	
Electromagnetic compatibility (EMC)	IEC/EN 60601-1-2	
Medical Devices Directive 93/42/EEC	Class IIb	
Protection against electric shock	Type CF applied part	
Degree of protection against the ingress of liquids	IP 20 (not protected)	
Degree of protection in the presence of flammable mixtures	Device is not protected against explosions (do not operate this device in explosive atmospheres)	
Dimensions and weights		
Weight	8.9 kg (19.5 lbs)	
Dimensions (W x H x D)	300 mm x 160 mm x 455 mm	

Relevant application parameters	
Insufflation medium	Medical-grade CO ₂ (degree of purity > 99.5%)
Intraabdominal pressure	3 mmHg to 25 mmHg (± 2 mmHg) selectable in increments of 1 mmHg
Gas flow rate primary filling	1 l/min (± 50%)
Gas flow rate, High Flow	2 l/min to 45 l/min (± 20%) selectable in increments of 1 l/min
Consumption indicator	0 l to 9,999 l (± 20%)

INSUFFLATOR HIGHFLOW 45 HEAT WITH GAS HEATING



		Product no.
Insufflator 45 HEAT bndl consisting of: Insufflator 45 HEAT FR 45 L/min(2235021) and power cable, 3 m long (2440.03)		22350212
Accessories: Tube sets for insufflation with heating		
Insufflation tube set L 3m high-flow with heating coil and integrated hygiene filter, (PACK=10 PCS), sterile, for single use		4170502
Insufflation tube for 2235021/031 L 3m , high-flow with heating coil, autoclavable Up to 100 uses are possible with the reusable hose.		8170202
Hygiene filter , sterile, disposable (PACK= 10 PCS) in individual sterile packaging		4171.111
Accessories for gas supply CO₂ bottle		
Qualityreg CO₂ , Inlet pressure connection DIN ISO 477-6 outlet connection NIST, pressure gauge Flow meter	DIN ISO 477-6	DM-DIN6-MS-NISTCO2
Qualityreg CO₂ , Inlet connection DIN EN ISO 407 PIN INDEX, outlet connection NIST ,pressure gauge Flow meter	DIN EN ISO 407 PIN INDEX	DM-PIN-MS-NIST-CO2
Qualityreg CO₂ , Inlet connection ISO 5145 outlet connection NIST, pressure gauge Flow meter	ISO 5145	DM-ISO-MS-NIST-CO2
with		
Connection hose, quality CONNECT , CO ₂ 1.5 m long		DINCO2NIST-NIST1.5
Optional for faster CO₂ bottle changes		
Quick plug adapter NIST , (2 pieces recommended) DIN with safety chain, adapter NIST / coupling with chain and ring		DM-AD-CO2NISTDINKU
Connection hose DIN, CO₂ , ZGV plug to NIST fitting, ISO-colored, 1.5 m long (Ceiling light)		DIN-CO2-ZGVNIST1.5
ZGV connection		
Connection hose, quality CONNECT , CO ₂ 5 m long, DIN for centralized CO ₂ gas supply (Dräger)		RW-CO2-ZGV-NIST5.0
Connection hose, quality CONNECT , CO ₂ 5 m long, NF for centralized CO ₂ gas supply (Liquid Air)		NF-CO2-ZGV-NIST5.0
Connection hose DIN, CO₂ , ZGV plug to NIST fitting, ISO-colored, 1.5 m long (Ceiling light)		DIN-CO2-ZGVNIST1.5
Software modules (optional)		
Software module CAN bus CAN bus interface for integration in CORE		2235101
Software module BABY MODE BABY MODE for special use in pediatrics		2235102
Software module VIDEO DISPLAY: video display using DIALOG via CAN bus		2235103

TECHNICAL DATA

INSUFFLATOR HIGHFLOW 45 HEAT

Insufflator 45 HEAT		2235021
Device properties		
Operating mode	Continuous operation	
Operating conditions	+10°C to +40°C, 30% to 75% rel. humidity, atmospheric pressure 700 hPa to 1,060 hPa	
Storage and transport conditions	-20°C to +60°C, 10% to 90% rel. humidity, atmospheric pressure 700 hPa to 1,060 hPa	
Power supply		
Mains + frequency	100–127/220–240 V~, 50/60 Hz	
Power consumption	80 VA	
Current rating	0.8–0.3 A	
Fuse	T 3.15 AH 250 V	
Regulatory standards		
Protection class to IEC/EN 60601-1 (UL 60601-1/CSA C222 No6011 – for USA)	I	
Electromagnetic compatibility (EMC)	IEC/EN 60601-1-2	
Medical Devices Directive 93/42/EEC	Class IIb	
Protection against electric shock	Type CF applied part	
Degree of protection against the ingress of liquids	IP 20 (not protected)	
Degree of protection in the presence of flammable mixtures	Device is not protected against explosions (do not operate this device in explosive atmospheres)	
Dimensions and weights		
Weight	11.0 kg (23.3 lbs)	
Dimensions (W x H x D)	300 mm x 160 mm x 455 mm	
Relevant application parameters		
Insufflation medium	Medical-grade CO ₂ (degree of purity > 99.5%)	
Intraabdominal pressure	3 mmHg to 25 mmHg (± 2 mmHg) selectable in increments of 1 mmHg	
Gas flow rate primary filling	1 l/min (± 50%)	
Gas flow rate, High Flow	2 l/min to 45 l/min (± 20%) selectable in increments of 1 l/min	
Consumption indicator	0 l to 9,999 l (± 20%)	

INSUFFLATOR HIGHFLOW 45 EVAC + HEAT

WITH SMOKE GAS EVACUATION AND GAS HEATING



		Artikel-Nr.
Insufflator 45 EVAC + HEAT bndl		22350312
consisting of: Insufflator 45 EVAC + HEAT FR 45 l/min(2235031), power cable, 3 m long (2440.03) and footswitch with 1 pedal (20301031)		
Accessories: Tube sets for insufflation with heating and smoke gas evacuation		
Insufflation tube set L 3m high-flow with heating coil and integrated hygiene filter, (PACK=10 PCS), sterile, for single use		4170502
Insufflation tube for 2235021/031 L 3m , high-flow with heating coil, autoclavable Up to 100 uses are possible with the reusable hose.		8170202
Hygiene filter , sterile, disposable (PACK= 10 PCS) in individual sterile packaging		4171.111
Smoke gas evacuation tube set , steril, sterile, for single use (PACK= 10 PCS)		2200/72BTUA1230001
Accessories for gas supply CO₂ bottle		
Qualityreg CO₂ , Inlet pressure connection DIN ISO 477-6 outlet connection NIST, pressure gauge Flow meter	DIN ISO 477-6	DM-DIN6-MS-NISTCO2
Qualityreg CO₂ , Inlet connection DIN EN ISO 407 PIN INDEX, outlet connection NIST ,pressure gauge Flow meter	DIN EN ISO 407 PIN INDEX	DM-PIN-MS-NIST-CO2
Qualityreg CO₂ , Inlet connection ISO 5145 outlet connection NIST, pressure gauge Flow meter	ISO 5145	DM-ISO-MS-NIST-CO2
with		
Connection hose, quality CONNECT , CO ₂ 1.5 m long		DINCO2NIST-NIST1.5
Optional for faster CO₂ bottle changes		
Quick plug adapter NIST , (2 pieces recommended) DIN with safety chain, adapter NIST / coupling with chain and ring		DM-AD-CO2NISTDINKU
Connection hose DIN, CO₂ , ZGV plug to NIST fitting, ISO-colored, 1.5 m long (Ceiling light)		DIN-CO2-ZGVNIST1.5
ZGV connection		
Connection hose, quality CONNECT , CO ₂ 5 m long, DIN for centralized CO ₂ gas supply (Dräger)		RW-CO2-ZGV-NIST5.0
Connection hose, quality CONNECT , CO ₂ 5 m long, NF for centralized CO ₂ gas supply (Liquid Air)		NF-CO2-ZGV-NIST5.0
Connection hose DIN, CO₂ , ZGV plug to NIST fitting, ISO-colored, 1.5 m long (Ceiling light)		DIN-CO2-ZGVNIST1.5
Software modules (optional)		
Software module CAN bus CAN bus interface for integration in CORE		2235101
Software module BABY MODE BABY MODE for special use in pediatrics		2235102
Software module VIDEO DISPLAY: video display using DIALOG via CAN bus		2235103



TECHNICAL DATA

INSUFFLATOR HIGHFLOW 45 EVAC + HEAT

Insufflator 45 EVAC + HEAT		2235031
Device properties		
Operating mode	Continuous operation	
Operating conditions	+10°C to +40°C, 30% to 75% rel. humidity, atmospheric pressure 700 hPa to 1,060 hPa	
Storage and transport conditions	-20°C to +60°C, 10% to 90% rel. humidity, atmospheric pressure 700 hPa to 1,060 hPa	
Power supply		
Mains + frequency	100–127/220–240 V~, 50/60 Hz	
Power consumption	80 VA	
Current rating	0.8–0.3 A	
Fuse	T 3.15 AH 250 V	
Regulatory standards		
Protection class to IEC/EN 60601-1 (UL 60601-1/CSA C222 No6011 – for USA)	I	
Electromagnetic compatibility (EMC)	IEC/EN 60601-1-2	
Medical Devices Directive 93/42/EEC	Class IIb	
Protection against electric shock	Type CF applied part	
Degree of protection against the ingress of liquids	IP 20 (not protected)	
Degree of protection in the presence of flammable mixtures	Device is not protected against explosions (do not operate this device in explosive atmospheres)	
Dimensions and weights		
Weight	11.0 kg (23.3 lbs)	
Dimensions (W x H x D)	300 x 160 x 455 mm	

Relevant application parameters	
Insufflation medium	Medical-grade CO ₂ (degree of purity > 99.5%)
Intraabdominal pressure	3 mmHg to 25 mmHg (± 2 mmHg) selectable in increments of 1 mmHg
Gas flow rate primary filling	1 l/min (± 50%)
Gas flow rate, High Flow	2 l/min to 45 l/min (± 20%) selectable in increments of 1 l/min
Consumption indicator	0 l to 9,999 l (± 20%)

STERILE SMOKE SET FOR SMOKE GAS DISCHARGE

		
		Product no.
<p>Smoke set smoke filter with tube (PACK= 10 PCS) in individual sterile packaging</p>		2200/47BDKBTUA123

||24|| Subject to modifications. Please note that some products may not be available in all countries. Please always take note of the information that is provided with the product. For more detailed information, please consult with your contact partner or directly with Richard Wolf GmbH.

FLUID CONTROL 2225

SUCTION IRRIGATION PUMP

core



		Product no.
FLUID CONTROL 2225 Irrigation pump for Hys/Uro/Lap bndl consisting of: Irrigation pump for Hys/Uro/Lap (2225001) and power cable 3 m long (2440.03)		22250011
for this:		
Balancing module for hysteroscopy and endourology, fluid management for fluid balancing in combination with FLUID CONTROL 2225, mobile stand with integrated weighing cells and space for up to 4 irrigation fluid bags		2225023

Accessories		Product no.
Footswitch	only for use in urology and within the indication TUR/enucleation, possibility of short-term increase in pressure if visibility is poor (Flush function)	2204901

x2z|| Subject to modifications. Please note that some products may not be available in all countries. Please always take note of the information that is provided with the product. For more detailed information, please consult with your contact partner or directly with Richard Wolf GmbH.

FLUID CONTROL 2225

SUCTION IRRIGATION TUBE SETS

Irrigation			Product no.
Accessories – reusable	Tube set with piercing spike	with Luer-Lock connection, autoclavable, incl. 10 spare membranes, reusable for 20 reprocessing cycles	8171223
Accessories – disposable	Irrigation tube set with piercing spike, L 3 m	(PACK= 10 PCS), with Luer-Lock connection, sterile, disposable product	4171223
	Tube set with CARE-LOCK, L 3 m	(PACK= 10 PCS), sterile, disposable product	4171224
	Suction irrigation tube set	(PACK= 10 PCS), with piercing spike, sterile disposable product, PVC	4171225

Suction			Product no.
Accessories – reusable	Tube set for vacuum, incl. filter	with integrated hygiene filter, PACK= 10 PCS, service life: 30 days (connected to irrigation pump)	2206207
	Irrigation tube	L 1.2 m, with Luer-Lock, for suction irrigation handle 8385.901 and tube set 8171223 or 8170.223	817123
	Suction tube L 3 m	for suction irrigation handle 8385.901	8171402
	Secretion container, 2 l	2 liters, without cover	8170.6551
	Cover	for secretion trap 8170.6551, reusable	8170.6552
Accessories – disposable	Secretion container, 2.5 l	2.5 liters	41706566
	Secretion container bndl consisting of:	Secretion container 2.5 l (41706566) and secretion bag (PACK= 90 PCS) (41706564)	4170657
	Tube set for suction (2 connections)	sterile, disposable product, (PACK= 10 PCS) for connecting instruments to collecting container	T0503-01
	Angled 90° plug-in coupling	(PACK= 10 PCS) For connecting vacuum tube 2206207 to disposable container systems	0771019

FLUID CONTROL 2225

CABLE ACCESSORIES

		Product no.
Patch cable, RJ45 SFTP, 0.5 m	Cable length 0.5 m	72325378
Patch cable, RJ45 HRS TM11, 1.0 m	Cable length 1.0 m	72325429
Patch cable, RJ45 S/FTP CAT6 10 m	Cable length 10 m	72325434
Plastic caps for network socket	(PACK= 8 PCS)	5592105
Power cable	Cable length 3 m	2440.03

x2z|| Subject to modifications. Please note that some products may not be available in all countries. Please always take note of the information that is provided with the product. For more detailed information, please consult with your contact partner or directly with Richard Wolf GmbH.

TECHNICAL DATA

FLUID CONTROL 2225

FLUID CONTROL 2225		2225001
Device properties		
Operating conditions		+10°C to +40°C, 30% to 75% rel. humidity, 70 to 106 kPa atmospheric pressure 3,000 m max. altitude above sea level
Storage and transport conditions		-20°C to +60°C, 10% to 90% rel. humidity 70 to 106 kPa atmospheric pressure
Power supply		
Mains + frequency		100–240 V~, 50/60 Hz
Power consumption	100 V/60 Hz	110 VA
	240 V/50 Hz	120 VA
Current rating	100 V/60 Hz	1.10 A
	240 V/50 Hz	0.50 A
Fuse		T 3.15 AH, 250 V
Regulatory standards		
Protection class (I, II)		I
Electromagnetic compatibility (EMC)		EN 60601-1/IEC 60601-1 EN 60601-1-2/IEC 60601-1-2
Medical Devices Directive 93/42/EEC		Class IIb
Housing protection rating (IP code)		IP21
Protection against electric shock		Type BF applied part
Degree of protection in the presence of flammable mixtures		Device is not protected against explosions (do not operate this device in explosive atmospheres)
Maximum suction vacuum		-60 kPa
Dimensions and weights		
Weight		8.8 kg
Dimensions (W x H x D)		300 mm x 157 mm x 436 mm
Relevant application parameters		
Nominal flow range		Hysteroscopy: 800 ml/min (max. flow, not adjustable) Endourology: 10–800 ml/min (max. flow) Laparoscopy: 0.1–1.8 l/min (max. flow)
Suction power		max. 2 l/min
Starting nominal pressure range		Hysteroscopy: 15–200 mmHg Endourology: 15–90 mmHg/20–120 cmH2O Laparoscopy: 300 mmHg (not adjustable)
Pressure		0–300 mmHg
Deficit		-9,990 to +9,990 ml/0 to 99.9 l

TECHNICAL DATA

FLUID CONTROL 2225

Balancing module		2225023
Device properties		
Operating conditions	+10°C to +40°C, 30% to 75% rel. humidity, 70 to 106 kPa atmospheric pressure 3,000 m max. altitude above sea level	
Storage and transport conditions	-20°C to +60°C , 10% to 90% rel. humidity 70 to 106 kPa atmospheric pressure	
Regulatory standards		
Electromagnetic compatibility (EMC)	EN 60601-1/IEC 60601-1 EN 60601-1-2/IEC 60601-1-2	
Housing protection rating (IP code)	IP21	
Maximum load of container scale	16 kg/4 containers of 3 l each	
Maximum load of bag scale	23 kg/4 bags of 5 l each	
Dimensions and weights		
Weight	15.4 kg	
Dimensions (W x H x D)	618 mm x 1,064 mm x 618 mm	

Footswitch		2204901
Power supply		
Power supply connection	max. 24 V	
Power consumption	max. 0.1 A	
Regulatory standards		
Electromagnetic compatibility (EMC)	EN 60601-1/IEC 60601-1	
Housing protection rating (IP code)	IPX8	
Plug	7-pin circular connector	
Cable length	4.5 m	
Dimensions and weights		
Weight	300 g	
Dimensions (W x H x D)	66 mm x 27 mm x 91 mm	

FLUID CONTROL LAP 2216



		Product no.
FLUID CONTROL LAP suction irrigation pump bndl consisting of: LAP suction irrigation pump (2216001) and power cable 3 m long (2440.03)		22160011

Accessories		Product no.
Bracket	for fixing the suction container on the irrigator stand or MUT cart	2215.992
Universal holder	for FLUID CONTROL LAP on RIWomobil	32114605

x22| Subject to modifications. Please note that some products may not be available in all countries. Please always take note of the information that is provided with the product. For more detailed information, please consult with your contact partner or directly with Richard Wolf GmbH.

LAP SUCTION IRRIGATION PUMP 2216

SUCTION IRRIGATION TUBE SETS

Irrigation			Product no.
Accessories – reusable	Tube set with piercing spike	with Luer-Lock connection, autoclavable, incl. 10 spare membranes, reusable for 20 reprocessing cycles	8171223
Accessories – disposable	Irrigation tube set with piercing spike, L 3 m	(PACK= 10 PCS), with Luer-Lock connection, sterile, disposable product	4171223
	Tube set with CARE-LOCK, L 3 m	(PACK= 10 PCS), sterile, disposable product	4171224
	Suction irrigation tube set	(PACK= 10 PCS), with piercing spike, sterile disposable product, PVC	4171225

Suction			Product no.
Accessories – reusable	Tube set for vacuum, incl. filter	with integrated hygiene filter, PACK= 10 PCS, service life: 30 days (connected to irrigation pump)	2206207
	Irrigation tube	L 1.2 m, with Luer-Lock, for suction irrigation handle 8385.901 and tube set 8171223 or 8170.223	817123
	Suction tube L 3 m	for suction irrigation handle 8385.901	8171402
	Secretion container, 2 l	2 liters, without cover	8170.6551
	Cover	for secretion trap 8170.6551, reusable	8170.6552
Accessories – disposable	Secretion container, 2.5 l	2.5 liters	41706566
	Secretion container bndl consisting of:	Secretion container 2.5 l (41706566) and secretion bag (PACK= 90 PCS) (41706564)	4170657
	Tube set for suction (2 connections)	sterile, disposable product, (PACK= 10 PCS) for connecting instruments to collecting container	T0503-01
	Angled 90° plug-in coupling	(PACK= 10 PCS) For connecting vacuum tube 2206207 to disposable container systems	0771019

TECHNICAL DATA

FLUID CONTROL LAP 2216

LAP suction irrigation pump		2216001
Device properties		
Operating conditions	+10°C to +40°C, 30% to 75% rel. humidity, atmospheric pressure 700 hPa to 1,060 hPa 3,000 m max. altitude above sea level	
Storage conditions	+5°C to +40°C, 5% to 90% rel. humidity, atmospheric pressure 700 hPa to 1,060 hPa	
Transport and shipping conditions	-20°C to +60°C, 5% to 90% rel. humidity, atmospheric pressure 700 hPa to 1,060 hPa	
Power supply		
Mains + frequency	100–240 V~, 50/60 Hz	
Power consumption	100 V/60 Hz	65 VA
	240 V/50 Hz	96 VA
Current rating	100 V/60 Hz	0.65 A
	240 V/50 Hz	0.42 A
Protection class	I	
Electromagnetic compatibility (EMC)	IEC 60601-1/EN 60601-1 IEC 60601-1-2/EN 60601-1-2	
Medical Devices Directive 93/42/EEC	Class IIa	
Protection against electric shock	Type BF applied part	
Degree of protection against the ingress of liquids	IP 41	
Degree of protection in the presence of flammable mixtures	Device is not protected against explosions (do not operate this device in explosive atmospheres)	
Dimensions and weights		
Weight	4 kg	
Dimensions (W x H x D) with toggle screw	140 mm x 210 mm x 295 mm	

Relevant application parameters	
Maximum delivery rate	Rinsing: 2.0 l/min (± 10%), suction: 2.0 l/min (+0.4/-0.1 l/min)
Maximum pump pressure	400 mmHg (± 50 mmHg)
Motor cut-out	500 mmHg after 5 s (± 25 mmHg)
Suction pressure	between -50 kPa and -60 kPa
Connections	Equipotential bonding, vacuum connection

HF GENERATOR 2260

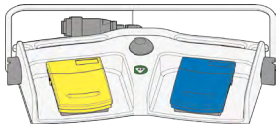

		Product no.
HF surgical generator 400 kHz	for the connection of monopolar and bipolar accessories, international version (BOWA, KLS Martin, Olympus, Karl Storz, Valleylab)	2260001
HF surgical generator 400 kHz	for the connection of monopolar and bipolar accessories, E version (Erbe)	2260002

Accessories required	Cable length	Product no.
Footswitch, 2 pedals L 5 m with fixed connection cable, reusable 		2260021
Neutral electrode for use with high-frequency surgical device, Foil bag with 5 neutral electrodes, (PACK= 50 PCS)		1280H
Mono HF neutral electrode cable, L 4.5 m	4.5 m	2260031
Power cable	3.0 m	2440.03
Bipo HF connection cable L 3 m	3.0 m	8108233
Bipo HF connection cable L 5 m	5.0 m	8108253

HF GENERATOR 2260

TECHNICAL DATA

HF surgical generator 400kHz		2260001/2260002
Device properties		
Type of controls on housing front		Touch panel
Output power	max.cutting power	400 W
	max.coagulation power	350 W
LF and HF leakage currents		acc. to DIN EN 60601 1 and DIN EN 60601 2 2
Signal level		HF indicator 55 dB(A); adjustable 45–60 dB(A) Alarm 65 dB(A)
Operating conditions		+10°C to +40°C, 30% to 75% rel humidity, 700 hPa to 1,060 hPa atmospheric pressure
Storage and transport conditions		- 20°C to + 60°C, 10% to 90% rel humidity, 700 hPa to 1,060 hPa atmospheric pressure
Power supply		
Mains + frequency		100–240 V~, 50/60 Hz
Power consumption	without HF output	45 VA
	at max. output power	650 VA
Current rating		max. 6.3 A
Fuse		T 6.3 AH 250 V
Regulatory standards		
Protection class to EN/IEC 60601-1 (UL 2601-1/CSA C222 No6011 – for USA)		I
Electromagnetic compatibility (EMC)		EN/IEC 60601-1-2
Medical Devices Directive 93/42/EEC		Class IIb
Degree of protection against the ingress of liquids (DIN EN/IEC 60529)		IPX0
Degree of protection against the ingress of solids		IP2X
Duty factor (duty cycle DC)		Intermittent INT 10 s/30 s corresponding to 25% DC
Protection against electric shock		Model CF applied part, defibrillator-proof
Degree of protection in the presence of flammable mixtures		Device is not protected against explosions (do not operate this device in explosive atmospheres)
Dimensions and weights		
Weight		10.2 kg (22.4 lbs)
Dimensions (W x H x D)		300 x 159 x 419 mm

HF CONNECTION CABLE MONO 815xxx

Instrument connector	Device connector		Product no.
<p>WOLF Resectoscopes</p> 		<p>HF connection cable mono L 3 m</p>	<p>815.032</p>
	<p>ERBE (ACC/ICC/IO)/BOWA (EU) R. Wolf HF surgical generator 400 kHz 2260002</p>	<p>HF connection cable mono L 5 m</p>	<p>815.052</p>
		<p>HF connection cable mono L 3 m</p>	<p>815.132</p>
	<p>ERBE (T series)</p>	<p>HF connection cable mono L 5 m</p>	<p>815.152</p>
<p>HF electrodes, monopolar</p> 		<p>HF connection cable mono L 3 m</p>	<p>815.031</p>
	<p>Martin (M-version)/Berchtold/ Aesculap</p>	<p>HF connection cable mono L 5 m</p>	<p>815.051</p>
	<p>Bovie/Valleylab/Erbe (Int.)/ BOWA (Int.) R. Wolf HF surgical generator 400 kHz 2260001</p>	<p>HF connection cable mono L 3 m</p>	<p>815.033</p>
	<p>HF connection cable mono L 5 m</p>	<p>815.053</p>	
	<p>BOWA (Int./EU) Eschmann and other devices with 4 mm plugs R. Wolf HF surgical generator 400 kHz 2260001</p>	<p>HF connection cable mono L 3 m</p>	<p>815.034</p>
	<p>HF connection cable mono L 5 m</p>	<p>815.054</p>	









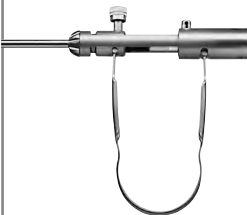

x2|| Subject to modifications. Please note that some products may not be available in all countries. Please always take note of the information that is provided with the product. For more detailed information, please consult with your contact partner or directly with Richard Wolf GmbH.

HF CONNECTION CABLE MONO 8106xxx

Instrument connector	Device connector		Product no.	
<p>WOLF Instruments/surgical generator</p> 	 <p>Erbe (ACC/ICC/VIO)/BOWA (EU) R. Wolf HF surgical generator 400 kHz 2260002</p>	HF connection cable mono L 3 m	8106.032	
		HF connection cable mono L 5 m	8106.052	
	 <p>Erbe (T series)</p>	HF connection cable mono L 3 m	8106.132	
		HF connection cable mono L 5 m	8106.152	
	<p>HF electrodes, monopolar</p> 	 <p>Martin (M-version)/Berchtold/ Aesculap</p>	HF connection cable mono L 3 m	8106.031
			HF connection cable mono L 5 m	8106.051
		 <p>Bovie/Valleylab/Erbe (Int.)/ BOWA (Int.) R. Wolf HF surgical generator 400 kHz 2260001</p>	HF connection cable mono L 3 m	8106.033
			HF connection cable mono L 5 m	8106.053
 <p>BOWA (Int./EU) Eschmann and other devices with 4 mm plugs R. Wolf HF surgical generator 400 kHz 2260001/2260002</p>	HF connection cable mono L 3 m	8106.034		
	HF connection cable mono L 5 m	8106.054		







BIPO HF CONNECTION CABLE

8108xxx

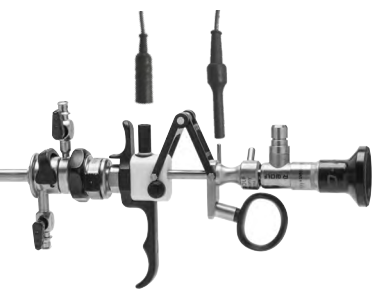

Instrument connector	Device connector		Product no.	
WOLF Bipolar forceps 	 ERBE (ACC/ICC/T)/BOWA (EU) R. Wolf HF surgical generator 400 kHz 2260001/2260002	HF connection cable bipo; L 3 m	8108.032	
		HF connection cable bipo; L 5 m	8108.052	
	 International / 2-pin Valleylab R. Wolf HF surgical generator 400 kHz 2260001/2260002	HF connection cable bipo; L 3 m	8108.033	
		HF connection cable bipo; L 5 m	8108.053	
	 WOLF/Martin (M-version)/ Berchtold/Aesculap	HF connection cable bipo; L 3 m	8108.031	
		HF connection cable bipo; L 5 m	8108.051	
	 EMC Dolley	HF connection cable bipo; L 3 m	8108035	
	Bipolar tweezers connection 	 ERBE (ACC/ICC/T)/BOWA (EU) R. Wolf HF surgical generator 400 kHz 2260001/2260002	HF connection cable bipo; L 3 m	8108.132
			HF connection cable bipo; L 5 m	8108.152
 International / 2-pin Valleylab R. Wolf HF surgical generator 400 kHz 2260001/2260002		HF connection cable bipo; L 3 m	8108.133	
		HF connection cable bipo; L 5 m	8108.153	
 Martin (M-version)/Berchtold/ Aesculap		HF connection cable bipo; L 3 m	8108.131	
		HF connection cable bipo; L 5 m	8108.151	
 EMC Dolley		HF connection cable bipo; L 3 m	8108135	

x22| Subject to modifications. Please note that some products may not be available in all countries. Please always take note of the information that is provided with the product. For more detailed information, please consult with your contact partner or directly with Richard Wolf GmbH.

HF CONNECTION CABLE BIPO FOR RESECTION IN SALINE SOLUTION

Instrument connector	Device connector		Product no.	
<p>WOLF Bipolar resectoscopes</p> 	 Erbe VIO 300D	<p>Bipolar cable; TUR/TCR; WOLF MF plug; L 4 m</p>	<p>20196-119</p>	
	 Erbe VIO 3	<p>BIPOLAR CABLE; MF-U MF plug; L 4.5 m</p>	<p>21196-119</p>	
	 KLS Martin	<p>HF connection cable bipo; L 3 m</p>	<p>8108.231</p>	
	 KLS Martin	<p>HF connection cable bipo; L 5 m</p>	<p>8108.251</p>	
	 R. Wolf HF surgical generator 400 kHz 2260001/2260002			
	 R. Wolf HF surgical generator 400 kHz 2260001/2260002			

MONO HF NEUTRAL ELECTRODE CABLE

Instrument connector	Device connector		Product no.
<p>2-pole neutral electrode</p> 	 <p>R. Wolf HF surgical generator 400 kHz 2260001/2260002</p>	<p>Mono HF neutral electrode cable, L 4.5 m</p>	<p>2260031</p>

x22|| Subject to modifications. Please note that some products may not be available in all countries. Please always take note of the information that is provided with the product. For more detailed information, please consult with your contact partner or directly with Richard Wolf GmbH.

TÜBINGER MIC TRAINING DEVICE

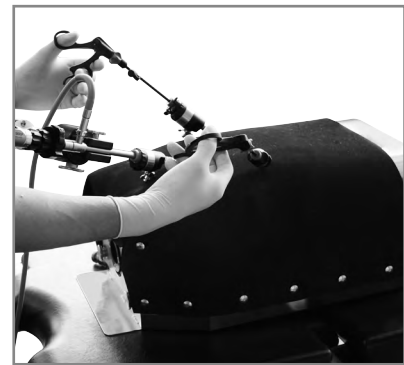

		Product no.
Tübinger MIC trainer with 3 abdominal walls (foam rubber)	(W x H x D) 560 x 350 x 230 mm	9500.056

Recommended accessories		Product no.
Abdominal wall, foam rubber, PACK= 5 PCS		9500.051
Available on request with transportation case		

x22| Subject to modifications. Please note that some products may not be available in all countries. Please always take note of the information that is provided with the product. For more detailed information, please consult with your contact partner or directly with Richard Wolf GmbH.

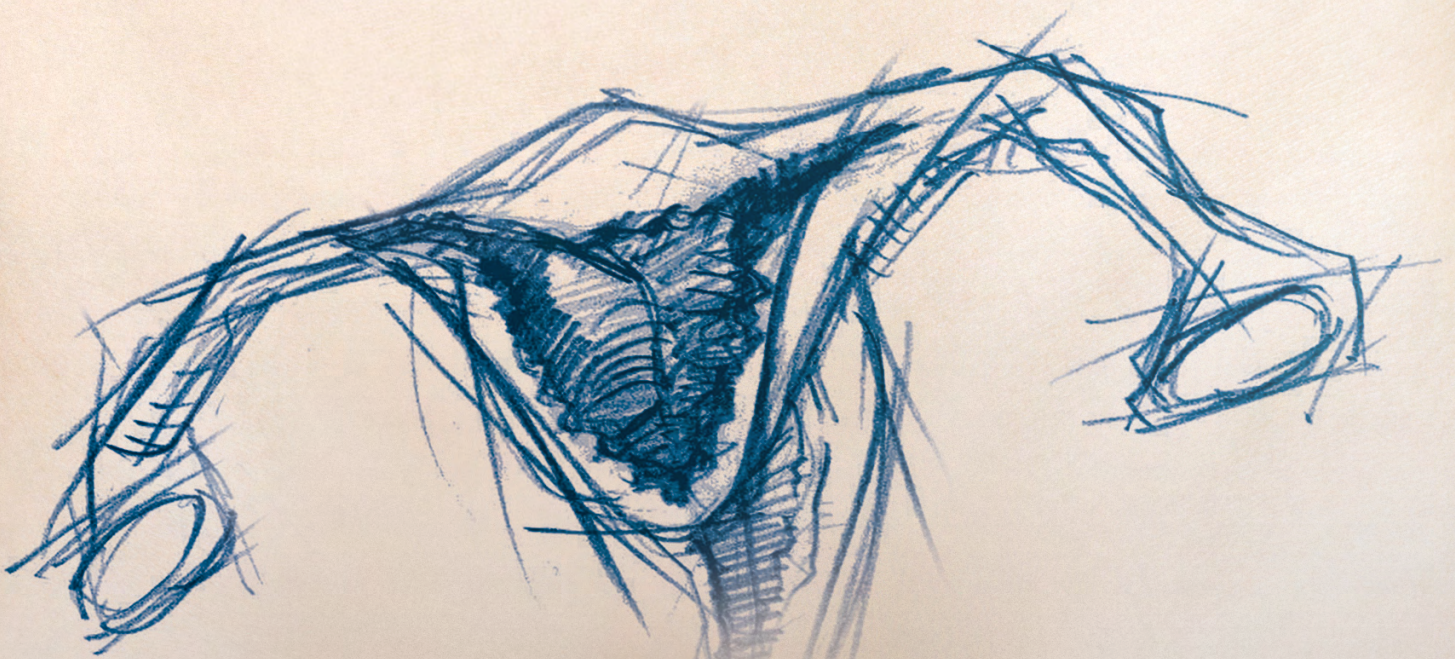

**DIAGNOSTIC AND
SURGICAL HYSTEROSCOPY**

DIAGNOSTIC AND SURGICAL HYSTEROSCOPY

1

BASIC SETS

2

TELESCOPES

3

HYSTEROSCOPE SHEATHS FOR 2.5 MM/4.0 MM TELESCOPES

4

HYSTEROSCOPE Ø 3.9 MM, 30°/HYSTEROSCOPE Ø 5 MM, 20°

5

FORCEPS/SCISSORS/SMALL MODULAR SYSTEM **HySafe**

6

ELECTRODES, BIPOLAR, MONOPOLAR

7

INSTRUMENTS FOR PORTIO AND UTERUS

8

HYSTEROSCOPIC RESECTION

9

FLEXIBLE HYSTEROSCOPE

10

FLUID CONTROL

11

HF GENERATOR

12

ACCESSORIES

BASIC SET FOR DIAGNOSTIC HYSTEROSCOPY

Product	Product no.	Quantity	Catalog/Section
without working channel			
Telescope 30° Ø 2.7 mm SL 310 mm	8974.402	1	Gynecology / hysteroscopy
Sheath for hysteroscope 10.5 Fr	8985.11	1	
alternative:			
Hysteroscope bndl	89864021	1	Gynecology / hysteroscopy
Biopsy forceps bndl	8642.6312	1	
Grasping forceps bndl	8642.6502	1	

BASIC SET HYSTERO-RESECTOSCOPE
PRINCESS™ E-LINE & S(A)LINE SYSTEM,
TELESCOPE 2.7 MM, 12°, 21 FR, PASSIVE, CONTINUOUS IRRIGATION

Product	Product no.	Quantity	Catalog/Section
Outer sheath for resectoscope 21 Fr	8653.021	1	Gynecology / hysteroscopy
Inner sheath for resectoscope 19 Fr	8653.018	1	
Obturator for resectoscope 19 Fr	8653.18	1	
Passive, mono/bipo working element with open handle, passive cutting	8653.224	1	
Telescope 12° Ø 2.7 mm SL 310 mm	8974.412	1	
Cutting electrode bipo 21 Fr	46531313	1	
Roller electrode bipo 21/24.5 Fr	4653.023	1	
Hook electrode mono/bipo 21/24.5 Fr	865303	1	
Protective sterilization sleeve for connection to max. 5 electrodes, reusable	33030	1	
Bipolar HF cable	8108....	1	
FLUID CONTROL 2225 Irrigation pump for HYS/URO/LAP bndl	22250011	1	
Balancing module	2225023	1	

MINI FIBER TELESCOPE 2.0 MM

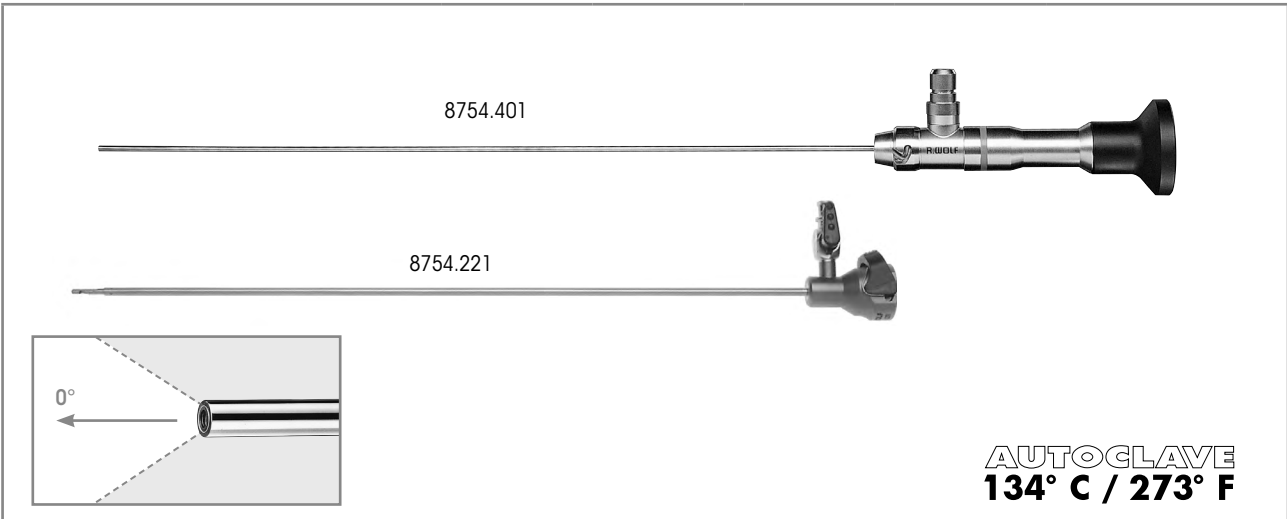

	Direction of view	WL	TL	Ø	Product no.
Telescope 0° Ø 2 mm NL 268 mm	0°	268 mm	365 mm	2.0 mm	8754401
also:					
VERES cannula Ø 2.3 mm WL 250 mm consisting of: 1x VERES cannula Ø 2.3 mm WL 274 mm (8754.211) 1x outer sheath Ø 2.8 mm, WL 250 mm (8754.221)		250 mm		2.3 mm	8754201

Recommended accessories		Product no.
Perforated basket for standard telescope 2 (for telescope 8754.401)	(L x W x H) 481 x 59 x 54 mm	38016
Fiber light cable bndl consisting of: Fiber light cable (80662523), projector-side adapter (8095.07), and endoscope-side adapter (809509)	Ø 2.5 mm, 2.3 m long	806625231

||22|| Subject to modifications. Please note that some products may not be available in all countries. Please always take note of the information that is provided with the product. For more detailed information, please consult with your contact partner or directly with Richard Wolf GmbH.

MINI SURGICAL HYSTEROSCOPE

TELESCOPES
2



	Direction of view	W x H	WL	TL	Product no.
Telescope 12° W 3.6 mm H 2 mm WL 227 mm with lateral eyepiece	12°	3.6 x 2.0 mm	227 mm	358 mm	8753.411

also:

	Color coding	WL	Outer Ø	Working channel	Product no.
Outer sheath for hysteroscope 15 Fr	yellow	214 mm	3.8 mm	3 Fr	8753.001
Inner sheath for hysteroscope		-	1.5 mm		8753.002
Outer sheath for hysteroscope 15 Fr	blue	214 mm	4.8 mm	5 Fr	8753.003
Inner sheath for hysteroscope		-	2.2 mm x 3.42 mm		8753.004
Outer sheath for hysteroscope 15.5 Fr	green	214 mm	5.4 mm	7 Fr	8753.006
Inner sheath for hysteroscope		-	2.8 mm x 2.98 mm		8753.007
Outer sheath for hysteroscope 17.5 Fr	white	214 mm	5.8 mm	9 Fr	8753.008
Inner sheath for hysteroscope		-	3.5 mm x 4.04 mm		8753.009

Recommended accessories	Product no.
Rigid grasping forceps Ø 3 mm WL 346 mm 	8993.235
Perforated basket for hysteroscope 1 for holding replacement sheaths, with small parts basket	Internal dimens. (W x H x D): 51 x 65 x 124 mm External dimens. (W x H x D): 467 x 75 x 132 mm 38006
Fiber light cable bndl consisting of: Fiber light cable (80662523), projector-side adapter (8095.07), and endoscope-side adapter (809509)	Ø 2.5 mm, 2.3 m long 806625231

1124|| Subject to modifications. Please note that some products may not be available in all countries. Please always take note of the information that is provided with the product. For more detailed information, please consult with your contact partner or directly with Richard Wolf GmbH.

HYSTEROSCOPE TELESCOPES

Ø 2.7 MM/Ø 4.0 MM

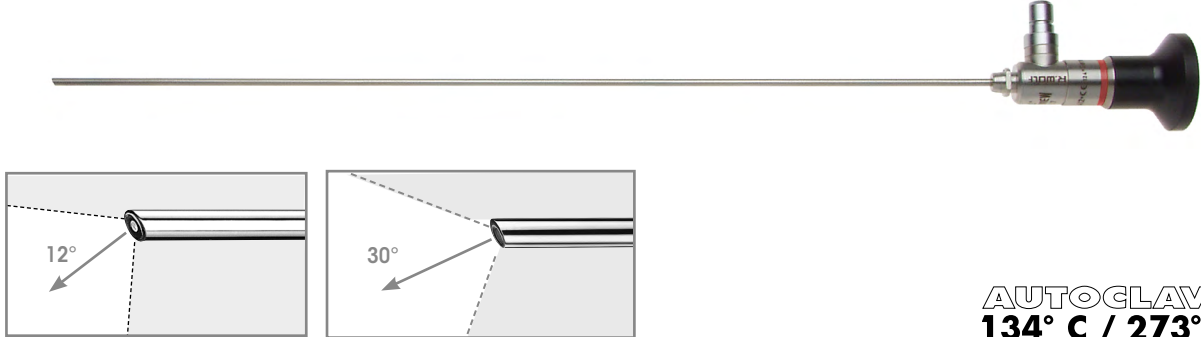

AUTOCLAVE
134° C / 273° F

	Direction of view	Ø	SL	TL	Product no.
Telescope 12° Ø 2.7 mm SL 310 mm	12°	2.7 mm	310 mm	373 mm	8974.412
Telescope 30° Ø 2.7 mm SL 310 mm	30°	2.7 mm	310 mm	370 mm	8974.402



AUTOCLAVE
134° C / 273° F



	Direction of view	Ø	SL	TL	Product no.
Telescope 30° Ø 4 mm SL 299 mm	30°	4.0 mm	299 mm	372 mm	8989.412

Recommended accessories		Product no.
Perforated basket for standard telescope 2	Dimensions (L x W x H): 481 x 59 x 54 mm	38016
Fiber light cable bndl consisting of: Fiber light cable (80662523), projector-side adapter (8095.07), and endoscope-side adapter (809509)	Ø 2.5 mm, 2.3 m long	806625231

DIAGNOSTIC HYSTEROSCOPE SHEATH

10.5 FR /Ø 3.5 MM

FOR TELESCOPE 2.7 MM, 30°



						
		Sheath	WL		Product no.	
		10.5 Fr/ Ø 3.5 mm	255 mm		8985.11	
Sheath for hysteroscope 10.5 Fr round						
Handle for hysteroscope					8986.251	
also:						
		Direction of view	Ø	SL	TL	Product no.
Telescope 30° Ø 2.7 mm SL 310 mm		30°	2.7 mm	310 mm	370 mm	8974.402

Recommended accessories		Product no.
Perforated basket for standard telescope 2	Dimensions (L x W x H): 481 x 59 x 54 mm	38016
Fiber light cable bndl consisting of: Fiber light cable (80662523), projector-side adapter (8095.07), and endoscope-side adapter (809509)	Ø 2.5 mm, 2.3 m long	806625231

||24|| Subject to modifications. Please note that some products may not be available in all countries. Please always take note of the information that is provided with the product. For more detailed information, please consult with your contact partner or directly with Richard Wolf GmbH.

DIAGNOSTIC HYSTEROSCOPE SHEATH 12 FR, OVAL

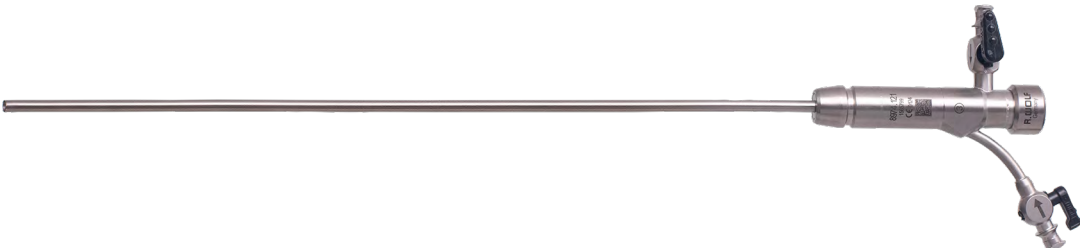
FOR TELESCOPE 2.7 MM, 30°

					
	Sheath	Working channel	WL	Product no.	
	12 Fr	3 Fr	246 mm	8974.121	
Sheath for hysteroscope 12 Fr oval					
					8986.251
Handle for hysteroscope					
also:					
	Direction of view	Ø	SL	TL	Product no.
Telescope 30° Ø 2.7 mm SL 310 mm	30°	2.7 mm	310 mm	370 mm	8974.402

Recommended accessories		Product no.
Perforated basket for standard telescope 2	Dimensions (L x W x H): 481 x 59 x 54 mm	38016
Fiber light cable bndl consisting of: Fiber light cable (80662523), projector-side adapter (8095.07), and endoscope-side adapter (809509)	Ø 2.5 mm, 2.3 m long	806625231

OptiFLOW™

HIGHFLOW CONTINUOUS IRRIGATION SURGICAL SHEATH



5.5 MM

FOR TELESCOPE 2.7 MM, 12° AND 30°

SHEATHS

3



	Sheath Ø	Working channel	WL	Product no.	
 Sheath for hysteroscope 16.5 Fr distal sheath end, oval	16.5 Fr	5 Fr	219 mm	8974351	
Handle for hysteroscope				8986.251	
also:					
	Direction of view	Ø	SL	TL	Product no.
Telescope 12° Ø 2.7 mm SL 310 mm	12°	2.7 mm	310 mm	373 mm	8974.412
Telescope 30° Ø 2.7 mm SL 310 mm	30°	2.7 mm	310 mm	370 mm	8974.402



Recommended accessories	Product no.
Perforated basket for standard telescope 2	38016
Fiber light cable bndl consisting of: Fiber light cable (80662523), projector-side adapter (8095.07), and endoscope-side adapter (809509)	806625231

||24|| Subject to modifications. Please note that some products may not be available in all countries. Please always take note of the information that is provided with the product. For more detailed information, please consult with your contact partner or directly with Richard Wolf GmbH.

DIAGNOSTIC HYSTEROSCOPE SHEATH

15 FR



FOR TELESCOPE 4 MM, 30°

					
	Sheath Ø	Working channel	WL	Product no.	
 Sheath for hysteroscope 15 Fr distal sheath end, oval	15 Fr	3 Fr	255 mm	8989.151	
Handle for hysteroscope				8986.251	
also:					
	Direction of view	Ø	SL	TL	Product no.
Telescope 30° Ø 4 mm SL 299 mm	30°	4.0 mm	299 mm	372 mm	8989.412

Recommended accessories	Product no.
Perforated basket for standard telescope 2	Dimensions (L x W x H): 481 x 59 x 54 mm 38016
Fiber light cable bndl consisting of: Fiber light cable (80662523), projector-side adapter (8095.07), and endoscope-side adapter (809509)	Ø 2.5 mm, 2.3 m long 806625231

SURGICAL CONTINUOUS IRRIGATION HYSTEROSCOPE SHEATH 15 FR OVAL

FOR TELESCOPE 4 MM, 30°







					
	Sheath	Working channel	WL	Product no.	
	15 Fr	3 Fr	230 mm	8989.031	
Sheath for hysteroscope 15 Fr distal sheath end, oval					
				8986.251	
Handle for hysteroscope					
also:					
	Direction of view	Ø	SL	TL	Product no.
Telescope 30° Ø 4 mm SL 299 mm	30°	4.0 mm	299 mm	372 mm	8989.412

Recommended accessories	Product no.
Perforated basket for standard telescope 2	Dimensions (L x W x H): 481 x 59 x 54 mm 38016
Fiber light cable bndl consisting of: Fiber light cable (80662523), projector-side adapter (8095.07), and endoscope-side adapter (809509)	Ø 2.5 mm, 2.3 m long 806625231

SURGICAL CONTINUOUS IRRIGATION HYSTEROSCOPE SHEATH

21 FR

FOR TELESCOPE 4 MM, 30°

byGallinat					
8988.031 					
8988.231 					
8988.241 					
		Sheath	Working channel	WL	Product no.
	with oblique distal end, rotatable drain stopcock, and quick release lock	21 Fr	-	204 mm	8988.031
also:					
	specifically for 8988.031				8988.131
	with deflection lever and supply stopcock		7 Fr		8988.231
	with ramp and supply stopcock		7 Fr		8988.241
also:					
	Direction of view	Ø	SL	TL	Product no.
Telescope 30° Ø 4 mm SL 299 mm	30°	4.0 mm	299 mm	372 mm	8989.412
Recommended accessories					Product no.
Perforated basket for standard telescope 2		Dimensions (L x W x H): 481 x 59 x 54 mm			38016
Fiber light cable bndl consisting of: Fiber light cable (80662523), projector-side adapter (8095.07), and endoscope-side adapter (809509)		Ø 2.5 mm, 2.3 m long			806625231



||24|| Subject to modifications. Please note that some products may not be available in all countries. Please always take note of the information that is provided with the product. For more detailed information, please consult with your contact partner or directly with Richard Wolf GmbH.

HYSTEROSCOPE

3.9 MM, 30°

HYSTEROSCOPE

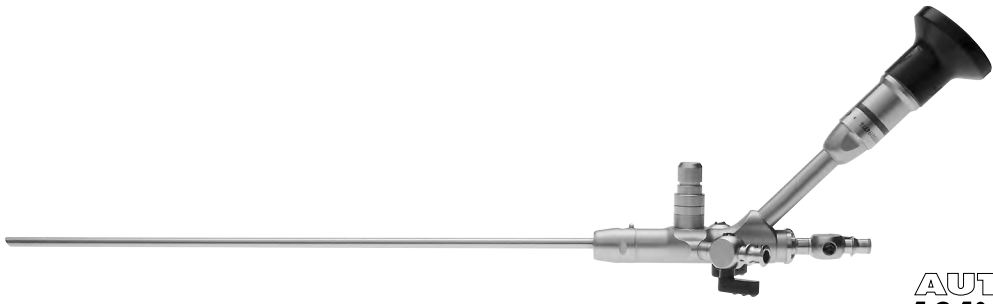
4

 <p>AUTOCLAVE 134° C / 273° F</p>				
	Sheath	Working channel	WL	Product no.
 <p>Hysteroscope bndl consisting of: Hysteroscope 30° Ø 3.9 mm WL 217 mm (8986402) and rubber cap capacity 0.8 mm (PACK = 10 PCS, 88.01)</p>	Ø 3.9 mm	5 Fr	217 mm	89864021
<p>Handle for hysteroscope</p>				8986.251

Recommended accessories		Product no.
<p>Perforated basket for hysteroscope 2 with small part basket</p>	<p>Internal dimensions (W x H x D): 451 x 80 x 124 mm, External dimensions (W x H x D): 467 x 90 x 132 mm</p>	38009
<p>Fiber light cable bndl consisting of: Fiber light cable (80662523), projector-side adapter (8095.07), and endoscope-side adapter (809509)</p>	Ø 2.5 mm, 2.3 m long	806625231



||24|| Subject to modifications. Please note that some products may not be available in all countries. Please always take note of the information that is provided with the product. For more detailed information, please consult with your contact partner or directly with Richard Wolf GmbH.

HYSTEROSCOPE

5 MM, 20°





AUTOCLAVE
134° C / 273° F

	Sheath	Working channel	WL	Product no.
 Hysteroscope 20° Ø 5 mm WL 217 mm with lateral eyepiece	Ø 5 mm	5 Fr	217 mm	8986.401
Handle for hysteroscope				8986.251

Recommended accessories		Product no.
Perforated basket for hysteroscope 2 with small part basket	Internal dimensions (W x H x D): 451 x 80 x 124 mm, External dimensions (W x H x D): 467 x 90 x 132 mm	38009
Fiber light cable bndl consisting of: Fiber light cable (80662523), projector-side adapter (8095.07), and endoscope-side adapter (809509)	Ø 2.5 mm, 2.3 m long	806625231

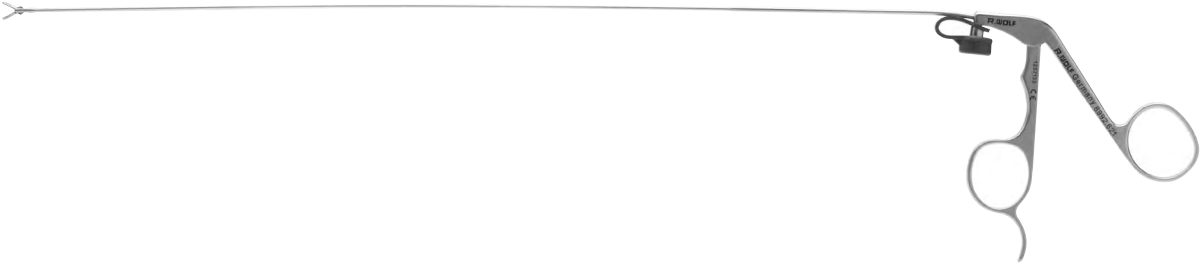
RIGID PREPARATION FORCEPS 7 FR







				
with irrigation connector	Fr	WL	TL	Product no.
 <p>Rigid preparation forceps 7 Fr WL 371 mm with internal and external toothings</p>	7 Fr	371 mm	460 mm	8992.621

1124 || Subject to modifications. Please note that some products may not be available in all countries. Please always take note of the information that is provided with the product. For more detailed information, please consult with your contact partner or directly with Richard Wolf GmbH.

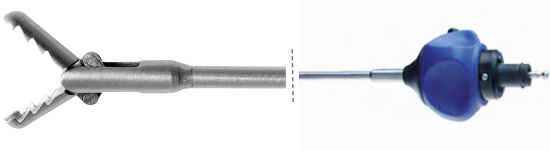

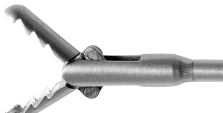
FORCEPS AND SCISSORS

SMALL MODULAR SYSTEM **HySafe**

360° ROTATABLE, CAN BE FLUSHED THROUGH, EASY CLICK

Grasping forceps jaw insert with sheath				Handle with overload protection	Complete instrument
					<ul style="list-style-type: none"> Jaw section Handle
	Product no.	Fr	WL	8083.001	Product no.
	8642.6508	5	340 mm	•	8642.6502
	8992.6308	7	310 mm	•	8992.6302
	8642.6008	5	340 mm	•	8642.6002
	8642.6818	5	340 mm	•	8642.6812
	8642.6318	5	340 mm	•	8642.6312
	8992.6408	7	310 mm	•	8992.6402





MONOPOLAR ELECTRODE 5/6 FR





MONOPOLAR			
			
	Fr	WL	Product no.
 Coagulation electrode mono 6 Fr WL 400 mm	6 Fr	400 mm	823.06
 Needle electrode mono 5 Fr WL 420 mm	5 Fr	420 mm	824.05

HF connection cable: see page GYN162/163

1124 | Subject to modifications. Please note that some products may not be available in all countries. Please always take note of the information that is provided with the product. For more detailed information, please consult with your contact partner or directly with Richard Wolf GmbH.

FOR PORTIO AND UTERUS

	WL	TL	Product no.
			
 Uterus grasping forceps WL 92 mm, by Pozzi with distally overlapping tips	92 mm	254 mm	8370.25
 Uterus grasping forceps WL 100 mm, by Gimpelson with four spherical teeth	100 mm	242 mm	8371.10
 Uterus grasping forceps Ø 6.5 mm WL 100 mm, by Saarges	100 mm	262 mm	8370.00











for fixation, elevation, as well as hydro and chromopertubation of the uterus			
 (8378.90)			
 (8378.91)			
	WL	TL	Product no.
Intrauterine probes bndl consisting of: Intrauterine probe Ø 32 mm WL 32 mm, by Cohen (8378.00), conical portio adapter size small (8378.90), conical portio adapter size large (8378.91), tube with Luer-Lock connector (886.00)	32 mm	330 mm	8378001*

*also: Uterus grasping forceps WL 92 mm, by Pozzi (8370.25)

PRINCESS
PETIT RESECTOSCOPE INCLUDING
E-LINE & S(A)LINE SYSTEM



AUTOCLAVE
134° C / 273° F









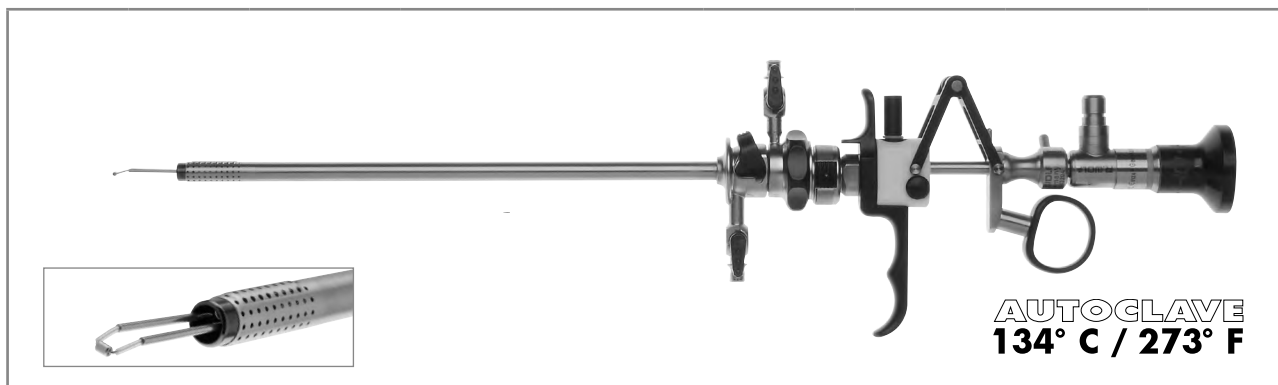

Size, Color coding	distal end	Outersheath for resectoscope 21 Fr	Inner sheath for resectoscope 19 Fr	Passive, mono/bipo working element with open handle		Telescope 12° Ø 2.7 mm SL 310 mm	Obturators	
				passive cutting	active cutting		Viewing obturator for resectoscope 19 Fr	Obturator for resectoscope 19 Fr
Sheaths								
7 mm 21 Fr black		8653.021	8653.018	8653.224	8653204	8974.412	865319	8653.18
also:								
Electrodes: see page GYN142								

Recommended accessories	Product no.
Working insert for resectoscope for auxiliary instruments up to 7 Fr	 8653284
HF monopolar connection cable	see page GYN162/163
Container (W x H x D) 400 X 60 X 200 mm	Internal dimensions (W x H x D): 400 x 57 x 200 mm External dimensions (W x H x D): 466 x 77 x 266 mm 33022
Fiber light cable bndl consisting of: Fiber light cable (80662523), projector-side adapter (809.507), and endoscope-side adapter (809509)	Ø 2.5 mm, 2.3 m long 806625231

||24|| Subject to modifications. Please note that some products may not be available in all countries. Please always take note of the information that is provided with the product. For more detailed information, please consult with your contact partner or directly with Richard Wolf GmbH.

PRINCESS
PETIT RESECTOSCOPE INCLUDING
E-LINE & S(A)LINE SYSTEM, ROTATABLE



Size, Color coding	distal end	Outersheath for resectoscope	Inner sheath for resectoscope	Working element with open handle		Telescope 12° Ø 2.7 mm SL 310 mm	Obturator	
				passive cutting	active cutting		Viewing obturator for resectoscope	Obturator for resectoscope
Sheaths								
7 mm 21 Fr black		21 Fr 8653022	19 Fr 8653019	8653.224	8653204	8974.412	19 Fr 865319	19 Fr 8653.18
8 mm 24.5 Fr green		24,5 Fr 8655.334	22 Fr 8655.344					
also:								
Electrodes: see page GYN142 								





Recommended accessories	Product no.
Working insert for resectoscope for auxiliary instruments up to 7 Fr 	8653284
HF monopolar connection cable	see page GYN162/163
Container (W x H x D) 400 X 60 X 200 mm	Internal dimensions (W x H x D): 400 x 57 x 200 mm External dimensions (W x H x D): 466 x 77 x 266 mm 33022
Fiber light cable bndl consisting of: Fiber light cable (80662523), projector-side adapter (809.507), and endoscope-side adapter (809509)	Ø 2.5 mm, 2.3 m long 806625231

||24|| Subject to modifications. Please note that some products may not be available in all countries. Please always take note of the information that is provided with the product. For more detailed information, please consult with your contact partner or directly with Richard Wolf GmbH.

ELECTRODES

FOR PRINCESS RESECTOSCOPE,
TELESCOPE 2.7 MM, 12°

12°, for multiple use, monopolar/bipolar

	Designation	Bracket	for sheath sizes [in Fr]		Color coding		Product no.
			CI 21	CI 24.5	Fork	Stem	
	Cutting electrode mono 21 Fr	Loop round Ø 0.3 mm	•	–	red	blue	8653.131
	Cutting electrode mono 24.5 Fr	Loop round Ø 0.3 mm	–	•	blue	blue	8653.132
	Roller electrode mono 21/24.5 Fr	Roll	•	•	red	blue	8653.02
	Hook electrode mono/bipo 21/24.5 Fr	Hook	•	•	red	blue	865303

• suitable for corresponding sheath size – not suitable CI = continuous irrigation

12°, disposable, sterile* bipolar

(PACK = 3 PCS)	Designation	Bracket	for sheath sizes [in Fr]		Color coding		Product no.
			CI 21	CI 24.5	Fork	Stem	
	Cutting electrode bipo 21 Fr	Loop round Ø 0.3 mm	•	–	transparent	blue	46531313
	Cutting electrode bipo 24.5 Fr	Loop round Ø 0.3 mm	–	•	transparent	blue	4653.1323
	Roller electrode bipo 21/24.5 Fr	Roll	•	•	transparent	blue	4653.023
	BIVAP electrode bipo 21 Fr	Torus	•	–	blue	blue	46530213
	BIVAP electrode bipo 24.5 Fr	Torus	–	•	blue	blue	46530243
	Hook electrode 21/24.5 Fr	Hook	•	•	blue	blue	4653033

• suitable for corresponding sheath size – not suitable * in individual sterile packaging CI = continuous irrigation





Recommended accessories	Product no.
Protective sterilization sleeve for connection to max. 5 electrodes, reusable 	33030

1124|| Subject to modifications. Please note that some products may not be available in all countries. Please always take note of the information that is provided with the product. For more detailed information, please consult with your contact partner or directly with Richard Wolf GmbH.

RESECTION MASTER WITH AUTOMATIC CHIP SUCTION



AUTOGLAVE
134° C / 273° F

Size, Color coding	distal end	Outersheath for resectoscope 27 Fr	Working element passive mono/bipo	Telescope 30° Ø 3.3 mm SL 299 mm	Obturator for resectoscope
			passive cutting		
					
9 mm 27 Fr black		8659.071	8659.2351	8656.422	8659.175

Recommended accessories		Product no.
Tube set RESECTION PUMP 2228 disposable	PVC, (PACK = 10 PCS) in individual sterile packaging	4170.2228
HF monopolar connection cable		see page GYN162/163
Container (W x H x D) 400 X 60 X 200 mm	Internal dimensions (W x H x D): 400 x 57 x 200 mm External dimensions (W x H x D): 466 x 77 x 266 mm	33022
Fiber light cable bndl consisting of: Fiber light cable (80662523), projector-side adapter (809.507), and endoscope-side adapter (809509)	Ø 2.5 mm, 2.3 m long	806625231

ELECTRODES



FOR RESECTION MASTER WITH AUTOMATIC CHIP SUCTION

30°, for multiple use, monopolar/bipolar

	Designation	Bracket	for sheath sizes [in Fr]		Color coding		Product no.
			CI	27	Fork	Stem	
	Cutting electrode mono 27 Fr	Loop round Ø 0.25 mm	•		red	red	8659.161
	Vapo electrode mono 27 Fr	Loop cylindrical	•		blue	blue	8659.162
	Hook electrode mono/bipo 27 Fr	Hook	•		red	red	8659.163

CI = continuous irrigation

30°, disposable, sterile*, bipolar

(PACK = 3 PCS)	Designation	Bracket	for sheath sizes [in Fr]		Color coding		Product no.
			CI	27	Fork	Stem	
	Cutting electrode bipo 27 Fr	Loop round Ø 0.25 mm	•		blue	blue	4659.1613
	Roller electrode bipo 27 Fr	Loop Roll Ø 0.3 mm	•		blue	blue	4659.1623

* in individual sterile packaging CI = continuous irrigation

Recommended accessories

	Product no.
Protective sterilization sleeve for connection to max. 5 electrodes, reusable 	33030

RESECTION PUMP 2228

MICROPROCESSOR-CONTROLLED HIGH-PERFORMANCE CHIP SUCTION PUMP
WITH CLEAR LCD DISPLAY



		Product no.
RESECTION PUMP 2228 Suction pump		2228.001
also:		
Tube set RESECTION PUMP 2228 (PACK = 10 PCS.) packed singly, sterile	consisting of: Control tube with filter, irrigation tube with non-return valve, chip aspiration tube with non-return valve and pump tube	4170.2228
Bottle holder cpl.		64030.125
Bottle mount		64031.381
Overflow protection / bacteria filter for single use (PACK = 10 PCS)		2228.901
Chip collecting container 250 ml for tissue chips		2228.801
Tube insert for collecting container 250 ml		2228.802
Secretion container, 2 l	2 liters, without cover	8170.6551
Cover	for secretion trap 8170.6551, reusable	8170.6552
Sound absorber (PACK = 3 PCS)		35100.115
Connection tube recto pump		8170.6554
Power cable	cable length 3 m	2440.03

TECHNICAL DATA

RESECTION PUMP 2228

RESECTION PUMP 2228		2228.001
Device properties		
Operating conditions	+10°C to +40°C, 30% to 75% rel. humidity, atmospheric pressure 800 hPa to 1,060 hPa	
Storage and transport conditions	- 20°C to +60°C , 10% to 90% rel. humidity, atmospheric pressure 700 hPa to 1,060 hPa	
Power supply		
Mains + frequency	100–240 V~, 50/60 Hz	
Power consumption	120 VA	
Current rating	1.2–0.5	
Fuse	T 1.6 AL 250 V	
Regulatory standards		
Protection class to EN/IEC 60601-1 (UL 2601-1/CSA C22.2 No.601.1 – for USA)	I	
Electromagnetic compatibility (EMC)	EN/IEC 60601-1-2	
Medical Devices Directive 93/42/EEC	Class II a	
Degree of protection against the ingress of liquids	IP 20 (not protected)	
Noise level	55 dB (A) (pump "ON" with container)	
Operating mode	Continuous operation	
Protection against electric shock	Type BF applied part	
Degree of protection in the presence of flammable mixtures	Device is not protected against explosions (do not operate this device in explosive atmospheres)	
Dimensions and weights		
Weight, bndl with accessories	8.9 kg (19.6 lbs)	
Dimensions (W x H x D)	340 mm x 105 mm x 420 mm	
Space requirements with bottle holder (W x H x D)	470 mm x 410 mm x 430 mm	
Relevant application parameters		
Vacuum Operation vacuum Maximum vacuum	650 to 750 mbar +/- 50 mbar 750 mbar +/- 50 mbar	
Suction pulse Level 1 (low) Level 2 (medium) Level 3 (high)	3.8 ml +/- 0.5 ml 6.2 ml +/- 0.7 ml 9.2 ml +/- 1.0 ml	

Shark BIPOLAR RESECTOSCOPE







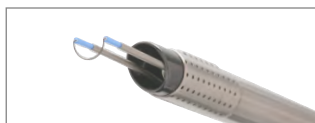

FOR TELESCOPE 4 MM, 30°, 12

WITH CONTINUOUS IRRIGATION DOUBLE SHEATH SYSTEM FOR RESECTION IN SALINE SOLUTION

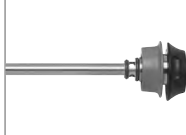
Working element, inner sheath, and telescope rotate in outer sheath



AUTOCLAVE
134° C / 273° F

Size, Color coding	distal end	Outersheath for resectoscope 24 Fr	Inner sheath for resectoscope 22 Fr	Telescope 30° Ø 4 mm NL 300 mm	Telescope 12° Ø 4 mm WL 297 mm	Obturators	
						Obturator for resectoscope 22 Fr	Viewing obturator for resecto- scope 22 Fr
Sheaths							
22/24 Fr green		8675424	8675322	8654.422	8654.431	8673022	8673122

also:

Working elements: see page GYN148

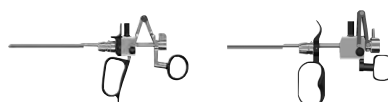





Electrodes: see page GYN149

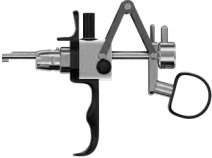

Recommended accessories	Product no.
HF bipolar connection cable	see page GYN164/165
Perforated basket for standard telescope 2	Internal dimensions (W x H x D): 454 x 52 x 40 mm External dimensions (W x H x D): 481 x 54 x 59 mm 38016
Fiber light cable bndl consisting of: Fiber light cable (80662523), projector-side adapter (8095.07), and endoscope-side adapter (809509)	Ø 2.5 mm, 2.3 m long 806625231

WORKING ELEMENTS

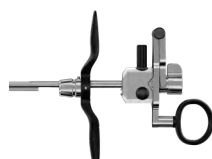

FOR  BIPOLAR RESECTOSCOPES
TELESCOPE 4 MM, 30°, 12°

		Handle variants	cutting	Product no.
Active working element bipo 0/12/30° Cut is made against spring pressure		open	active	8680.204
Active working element bipo 0/12/30° Cut is made against spring pressure		closed		8680.205
Passive working element bipo 0/12/30° Cut is made with spring pressure		open	passive	8680.224
Passive working element bipo 0/12/30° Cut is made with spring pressure		closed		8680.225

Recommended accessories		Product no.
Rubber cap, black (PACK = 5 PCS)	for sealing off the electrode clamping mechanism on the working element	8880
Thumb ring with relatively large inner diameter		15008.159

ELECTRODES

FOR  BIPOLAR RESECTOSCOPES
TELESCOPE 4 MM, 30°, 12°

12°/30°, for multiple use, bipolar							
	Designation	Bracket	for sheath sizes [in Fr]		Color coding		Model
			CI	22/24	Fork	Stem	
	Cutting electrode bipo 22 Fr 12/30°	Loop round Ø 0.3 mm	•		blue	yellow	8622133
	Coag. electrode bipo 22-26 Fr 12/30°	Cylinder Ø 1.2 mm	•		blue	yellow	8623022
	Hook electrode bipo 22-26 Fr 12/30°	Hook	•		blue	yellow	862309

- suitable for corresponding sheath size **CI** = continuous irrigation

12°/30°, disposable, sterile*, bipolar							
(PACK = 3 PCS)	Designation	Bracket	for sheath sizes [in Fr]		Color coding		Model
			CI	22/24	Fork	Stem	
	Cutting electrode mono 22 Fr 12/30°	Loop round Ø 0.25 mm	•		blue	blue	4622.2533
	Cutting electrode bipo 22 Fr 12/30°	Loop round Ø 0.3 mm	•		blue	blue	4622.1333
	Coag. electrode bipo 22 Fr 12/30°	Cylinder Ø 1.2 mm	•		blue	blue	4623.0243
	BIVAP electrode bipo 22 Fr 12/30°	Torus	•		blue	blue	46300223

- suitable for corresponding sheath size * in individual sterile packaging **CI** = continuous irrigation

Recommended accessories	Product no.
Protective sterilization sleeve for connection to max. 5 electrodes, reusable 	33030







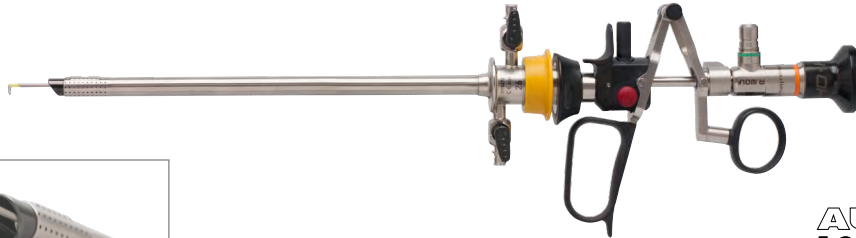
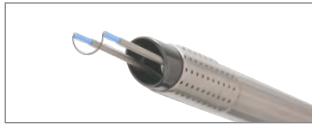

112411 Subject to modifications. Please note that some products may not be available in all countries. Please always take note of the information that is provided with the product. For more detailed information, please consult with your contact partner or directly with Richard Wolf GmbH.

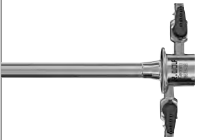
Shark MONOPOLAR RESECTOSCOPE
FOR TELESCOPE 4 MM, 30°, 12°
WITH CONTINUOUS IRRIGATION DOUBLE SHEATH SYSTEM

Working element, inner sheath, and telescope rotate in outer sheath

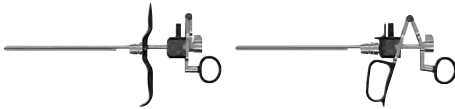

AUTOCLAVE
134° C / 273° F





Size, Color coding	distal end	Outersheath for resectoscope 24 Fr	Inner sheath for resectoscope 22 Fr	Telescope 30° Ø 4 mm NL 300 mm	Telescope 12° Ø 4 mm WL 297 mm	Obturator	
						Obturator for resectoscope 22 Fr	Viewing obturator for resecto- scope 22 Fr
Sheaths							
22/24 Fr green		8675424	8675322	8654.422	8654.431	8673022	8673122
also:							
Working elements: see page GYN151							
Electrodes: see page GYN152/153							

Recommended accessories	Product no.
HF monopolar connection cable	see page GYN162/163
Perforated basket for standard telescope 2	Internal dimensions (W x H x D): 454 x 52 x 40 mm External dimensions (W x H x D): 481 x 54 x 59 mm 38016
Fiber light cable bndl consisting of: Fiber light cable (80662523), projector-side adapter (809.507), and endoscope-side adapter (809509)	Ø 2.5 mm, 2.3 m long 806625231

1124|| Subject to modifications. Please note that some products may not be available in all countries. Please always take note of the information that is provided with the product. For more detailed information, please consult with your contact partner or directly with Richard Wolf GmbH.

WORKING ELEMENTS

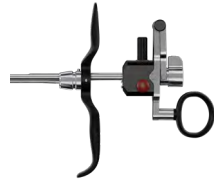
FOR  MONOPOLAR RESECTOSCOPES
TELESCOPE 4 MM, 30°, 12°

		Handle variants	cutting	Product no.
<p>Active working element mono 12/30°</p> <p>Cut is made against spring pressure</p>		closed	active	8674205
<p>Active working element mono 12/30°</p> <p>Cut is made against spring pressure</p>		closed with comfort thumb rest		8674234
<p>Passive working element mono 12/30°</p> <p>Cut is made with spring pressure</p>		open	passive	8674224
<p>Passive working element mono 12/30°</p> <p>Cut is made with spring pressure</p>		closed		8674225



Recommended accessories		Product no.
<p>Rubber cap, red (PACK = 5 PCS)</p>	for sealing off the electrode clamping mechanism on the working element	8874
<p>Thumb ring with relatively large inner diameter</p>		15008.159

||24|| Subject to modifications. Please note that some products may not be available in all countries. Please always take note of the information that is provided with the product. For more detailed information, please consult with your contact partner or directly with Richard Wolf GmbH.

ELECTRODES

FOR  MONOPOLAR RESECTOSCOPES
TELESCOPE 4 MM, 30°, 12°

12°/30°, for multiple use, monopolar

	Designation	Bracket	for sheath sizes [in Fr]		Color coding		Model
			CI	22/24	Fork	Stem	
	Cutting electrode mono 22 Fr 12/30°	Loop round Ø 0.35 mm		•	green	dark gray	86782235
	Coag. electrode mono 22–24 Fr 12/30°	Roll		•	green	dark gray	86782201
	Coag. electrode mono 22–24 Fr 12/30°	Sphere		•	green	dark gray	86782202
	Coag. electrode mono 22–24 Fr 12/30°	Button		•	green	dark gray	86782203
	Knife electrode mono 22–24 Fr 12/30°	Knife		•	green	dark gray	86782204
	Hook electrode mono 22–24 Fr 12/30°	Hook		•	green	dark gray	86782205
	Wing electrode mono 22 Fr 12/30°	Wing (bracket profile, flat)		•	green	dark gray	86782206

- suitable for corresponding sheath size **CI** = continuous irrigation

Recommended accessories

Product no.

Protective sterilization sleeve
for connection to max. 5 electrodes, reusable



33030

DISPOSABLE ELECTRODES

FOR  MONOPOLAR RESECTOSCOPES
TELESCOPE 4 MM, 30°, 12°

12°/30° disposable, sterile*, monopolar

	Designation	Bracket	for sheath sizes [in Fr]		Color coding		Model
			CI 22/24		Fork	Stem	
	Cutting electrode mono 22 Fr 12/30° (PACK = 10 PCS)	Loop round Ø 0.35 mm	•		green	transparent	46782235
	Cutting electrode mono 22 Fr 12/30° (PACK = 10 PCS)	Loop round Ø 0.25 mm	•		green	transparent	46782225
	Coag electrode mono 22-24 Fr 12/30° (PACK = 5 PCS)	Roll	•		green	transparent	46782201
	Coag electrode mono 22-24 Fr 12/30° (PACK = 5 PCS)	Sphere	•		green	transparent	46782202
	Coag electrode mono 22-24 Fr 12/30° (PACK = 5 PCS)	Button	•		green	transparent	46782203
	Knife electrode mono 22-24 Fr 12/30° (PACK = 5 PCS)	Knife	•		green	transparent	46782204
	Hook electrode mono 24 Fr 12/30° (PACK = 5 PCS)	Hook	•		green	transparent	46782205

- suitable for corresponding sheath size
- * in individual sterile packaging
- CI** = continuous irrigation

FLEXIBLE FIBER HYSTEROSCOPE

2.5 MM/7.5 FR

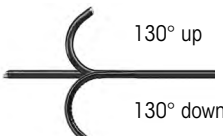



130° up
130° down

7305.782
included in scope of delivery



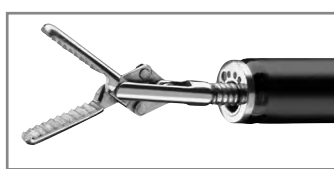



	Outer Ø	Working channel	WL	TL	Product no.
Fiber Hysteroscope Ø 2.5 mm WL 200 mm Slanted distal tip articulation +130/-130° direction of view 0°, angle of view 60°	2.5 mm 7.5 Fr	1.2 mm 3.6 Fr	200 mm	450 mm	7325.122
on request					
	Flex. grasping forceps Ø 1 mm WL 600 mm, rippled		600 mm	736 mm	7223.65

Recommended accessories	Product no.
Sterilization basket for flexible endoscopes	(W x H x D): 448 x 288 x 106 mm 33016
Fiber light cable bndl consisting of: Fiber light cable Ø 1.6 mm TL 1.8 m (80661618), projector-side adapter (809.507), and endoscope-side adapter (809509)	Ø 2.5 mm, 2.3 m long 806616181

1124|| Subject to modifications. Please note that some products may not be available in all countries. Please always take note of the information that is provided with the product. For more detailed information, please consult with your contact partner or directly with Richard Wolf GmbH.

FLUID CONTROL 2225

SUCTION IRRIGATION PUMP

core



		Product no.
FLUID CONTROL 2225 Irrigation pump for HYS/URO/LAP	Fluid management for flushing irrigation fluids into the uterus , as well as the upper and lower urinary tract, and for suction and irrigation in the abdomen	2225001
FLUID CONTROL 2225 Irrigation pump for HYS/URO/LAP bndI	consisting of: Irrigation pump for HYS/URO/LAP (2225001) Power cable (2440.03)	22250011
also:		
Balancing module	for hysteroscopy and endourology, fluid management for fluid balancing in combination with FLUID CONTROL 2225, mobile stand with integrated weighing cells and space for up to 4 irrigation fluid bags	2225023

FLUID CONTROL 2225

SUCTION IRRIGATION TUBE SETS

Irrigation			Product no.
Accessories – reusable	Tube set with piercing spike	with Luer-Lock connection, autoclavable, incl. 10 spare membranes, reusable for 20 reprocessing cycles	8171223
Accessories – disposable	Irrigation tube set with piercing spike, L 3 m	(PACK= 10 PCS), with Luer-Lock connection, sterile, disposable product	4171223
	Tube set with CARE-LOCK, L 3 m	(PACK= 10 PCS), sterile, disposable product	4171224
	Suction irrigation tube set	(PACK= 10 PCS), with piercing spike, sterile disposable product, PVC	4171225

Suction			Product no.
Accessories – reusable	Tube set for vacuum, incl. filter	with integrated hygiene filter, PACK= 10 PCS, service life: 30 days (connected to irrigation pump)	2206207
	Irrigation tube	L 1.2 m, with Luer-Lock, for suction irrigation handle 8385.901 and tube set 8171223 or 8170.223	817123
	Suction tube L 3 m	for suction irrigation handle 8385.901	8171402
	Secretion container, 2 l	2 liters, without cover	8170.6551
	Cover	for secretion trap 8170.6551, reusable	8170.6552
Accessories – disposable	Secretion container, 2.5 l	2.5 liters	41706566
	Secretion container bndl consisting of:	Secretion container 2.5 l (41706566) and secretion bag (PACK= 90 PCS) (41706564)	4170657
	Tube set for suction (2 connections)	sterile, disposable product, (PACK= 10 PCS) for connecting instruments to collecting container	T0503-01
	Angled 90° plug-in coupling	(PACK= 10 PCS) For connecting vacuum tube 2206207 to disposable container systems	0771019

FLUID CONTROL 2225

CABLE ACCESSORIES

		Product no.
Patch cable, RJ45 SFTP, 0.5 m	Cable length 0.5 m	72325378
Patch cable, RJ45 HRS TM11, 1.0 m	Cable length 1.0 m	72325429
Patch cable, RJ45 S/FTP CAT.6 10 m	Cable length 10 m	72325434
Plastic caps for network socket	(PACK = 8 PCS)	5592105
Power cable	Cable length 3 m	2440.03

TECHNICAL DATA

FLUID CONTROL 2225

FLUID CONTROL 2225		2225001
Device properties		
Operating conditions		+10°C to +40°C, 30% to 75% rel. humidity, 70 to 106 kPa atmospheric pressure 3,000 m max. altitude above sea level
Storage and transport conditions		-20°C to +60°C, 10% to 90% rel. humidity 70 to 106 kPa atmospheric pressure
Power supply		
Mains + frequency		100–240 V~, 50/60 Hz
Power consumption	100 V/60 Hz	110 VA
	240 V/50 Hz	120 VA
Current rating	100 V/60 Hz	1.10 A
	240 V/50 Hz	0.50 A
Fuse		T 3.15 AH, 250 V
Regulatory standards		
Protection class (I, II)		I
Electromagnetic compatibility (EMC)		EN 60601-1/IEC 60601-1 EN 60601-1-2/IEC 60601-1-2
Medical Devices Directive 93/42/EEC		Class IIb
Housing protection rating (IP code)		IP21
Protection against electric shock		Type BF applied part
Degree of protection in the presence of flammable mixtures		Device is not protected against explosions (do not operate this device in explosive atmospheres)
Maximum suction vacuum		-60 kPa
Dimensions and weights		
Weight		8.8 kg
Dimensions (W x H x D)		300 mm x 157 mm x 436 mm

Relevant application parameters	
Nominal flow range	Hysteroscopy: 800 ml/min (max. flow, not adjustable) Endourology: 10–800 ml/min (max. flow) Laparoscopy: 0.1–1.8 l/min (max. flow)
Suction power	max. 2 l/min
Starting nominal pressure range	Hysteroscopy: 15–200 mmHg Endourology: 15–90 mmHg/20–120 cmH2O Laparoscopy: 300 mmHg (not adjustable)
Pressure	0–300 mmHg
Deficit	-9,990 to +9,990 ml/0 to 99.9 l

TECHNICAL DATA

FLUID CONTROL 2225

Balancing module		2225023
Device properties		
Operating conditions	+10°C to +40°C, 30% to 75% rel. humidity, 70 to 106 kPa atmospheric pressure 3,000 m max. altitude above sea level	
Storage and transport conditions	- 20°C to + 60°C, 10% to 90% rel. humidity 70 to 106 kPa atmospheric pressure	
Regulatory standards		
Electromagnetic compatibility (EMC)	EN 60601-1/IEC 60601-1 EN 60601-1-2/IEC 60601-1-2	
Housing protection rating (IP code)	IP21	
Maximum load of container scale	16 kg/4 containers of 3 l each	
Maximum load of bag scale	23 kg/4 bags of 5 l each	
Dimensions and weights		
Weight	15.4 kg	
Dimensions (W x H x D)	618 mm x 1,064 mm x 618 mm	

HF GENERATOR 2260

core

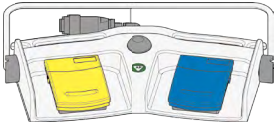

		Product no.
HF surgical generator 400 kHz	for the connection of monopolar and bipolar accessories, international version (BOWA, KLS Martin, Olympus, Karl Storz, Valleylab)	2260001
HF surgical generator 400 kHz	for the connection of monopolar and bipolar accessories, E version (Erbe)	2260002

Accessories required	Cable length	Product no.
Footswitch, 2 pedals L 5 m with fixed connection cable, reusable 		2260021
Neutral electrode for use with high-frequency surgical device, Foil bag with 5 neutral electrodes, (PACK= 50 PCS)		1280H
Mono HF neutral electrode cable, L 4.5 m	4.5 m	2260031
Power cable	3.0 m	2440.03
Bipo HF connection cable L 3 m	3.0 m	8108233
Bipo HF connection cable L 5 m	5.0 m	8108253







1124|| Subject to modifications. Please note that some products may not be available in all countries. Please always take note of the information that is provided with the product. For more detailed information, please consult with your contact partner or directly with Richard Wolf GmbH.

HF GENERATOR 2260

TECHNICAL DATA

HF surgical generator 400kHz		2260001/2260002
Device properties		
Type of controls on housing front		Touch panel
Output power	max.cutting power	400 W
	max.coagulation power	350 W
LF and HF leakage currents		acc. to DIN EN 60601 1 and DIN EN 60601 2 2
Signal level		HF indicator 55 dB(A); adjustable 45–60 dB(A) Alarm 65 dB(A)
Operating conditions		+10°C to +40°C, 30% to 75% rel humidity, 700 hPa to 1,060 hPa atmospheric pressure
Storage and transport conditions		- 20°C to + 60°C, 10% to 90% rel humidity, 700 hPa to 1,060 hPa atmospheric pressure
Power supply		
Mains + frequency		100–240 V~, 50/60 Hz
Power consumption	without HF output	45 VA
	at max. output power	650 VA
Current rating		max. 6.3 A
Fuse		T 6.3 AH 250 V
Regulatory standards		
Protection class to EN/IEC 60601-1 (UL 2601-1/CSA C222 No6011 – for USA)		I
Electromagnetic compatibility (EMC)		EN/IEC 60601-1-2
Medical Devices Directive 93/42/EEC		Class IIb
Degree of protection against the ingress of liquids (DIN EN/IEC 60529)		IPX0
Degree of protection against the ingress of solids		IP2X
Duty factor (duty cycle DC)		Intermittent INT 10 s/30 s corresponding to 25% DC
Protection against electric shock		Model CF applied part, defibrillator-proof
Degree of protection in the presence of flammable mixtures		Device is not protected against explosions (do not operate this device in explosive atmospheres)
Dimensions and weights		
Weight		10.2 kg (22.4 lbs)
Dimensions (W x H x D)		300 x 159 x 419 mm

HF CONNECTION CABLE MONO 815xxx

Instrument connector	Device connector		Product no.
<p>WOLF Resectoscopes</p> 		<p>HF connection cable mono L 3 m</p>	<p>815.032</p>
	<p>ERBE (ACC/ICC/IO)/BOWA (EU) R. Wolf HF surgical generator 400 kHz 2260002</p>	<p>HF connection cable mono L 5 m</p>	<p>815.052</p>
		<p>HF connection cable mono L 3 m</p>	<p>815.132</p>
	<p>ERBE (T series)</p>	<p>HF connection cable mono L 5 m</p>	<p>815.152</p>
<p>HF electrodes, monopolar</p> 		<p>HF connection cable mono L 3 m</p>	<p>815.031</p>
	<p>Martin (M-version)/Berchtold/ Aesculap</p>	<p>HF connection cable mono L 5 m</p>	<p>815.051</p>
	<p>Bovie/Valleylab/Erbe (Int.)/ BOWA (Int.) R. Wolf HF surgical generator 400 kHz 2260001</p>	<p>HF connection cable mono L 3 m</p>	<p>815.033</p>
	<p>HF connection cable mono L 5 m</p>	<p>815.053</p>	
	<p>BOWA (Int./EU) Eschmann and other devices with 4 mm plugs R. Wolf HF surgical generator 400 kHz 2260001</p>	<p>HF connection cable mono L 3 m</p>	<p>815.034</p>
	<p>HF connection cable mono L 5 m</p>	<p>815.054</p>	









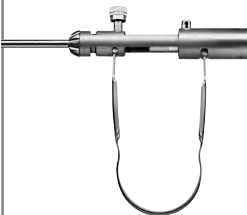

1124|| Subject to modifications. Please note that some products may not be available in all countries. Please always take note of the information that is provided with the product. For more detailed information, please consult with your contact partner or directly with Richard Wolf GmbH.

HF CONNECTION CABLE MONO 8106XXX

Instrument connector	Device connector		Product no.
<p>WOLF Instruments/surgical generator</p> 		<p>HF connection cable mono L 3 m</p>	<p>8106.032</p>
	<p>ERBE (ACC/ICC/IO)/BOWA (EU) R. Wolf HF surgical generator 400 kHz 2260002</p>	<p>HF connection cable mono L 5 m</p>	<p>8106.052</p>
		<p>HF connection cable mono L 3 m</p>	<p>8106.132</p>
	<p>ERBE (T series)</p>	<p>HF connection cable mono L 5 m</p>	<p>8106.152</p>
<p>HF electrodes, monopolar</p> 		<p>HF connection cable mono L 3 m</p>	<p>8106.031</p>
	<p>Martin (M-version)/Berchtold/ Aesculap</p>	<p>HF connection cable mono L 5 m</p>	<p>8106.051</p>
		<p>HF connection cable mono L 3 m</p>	<p>8106.033</p>
	<p>Bovie/Valleylab/Erbe (Int.)/ BOWA (Int.) R. Wolf HF surgical generator 400 kHz 2260001</p>	<p>HF connection cable mono L 5 m</p>	<p>8106.053</p>
		<p>HF connection cable mono L 3 m</p>	<p>8106.034</p>
	<p>BOWA (Int./EU) Eschmann and other devices with 4 mm plugs R. Wolf HF surgical generator 400 kHz 2260001/2260002</p>	<p>HF connection cable mono L 5 m</p>	<p>8106.054</p>







BIPO HF CONNECTION CABLE

8108xxx

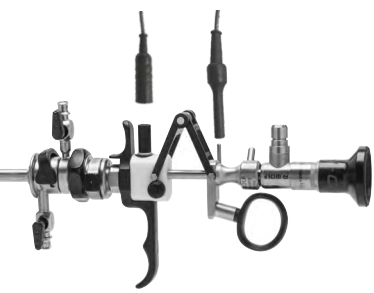

Instrument connector	Device connector		Product no.	
<p>WOLF Bipolar forceps</p> 	 <p>ERBE (ACC/ICC/T)/BOWA (EU) R. Wolf HF surgical generator 400 kHz 2260001/2260002</p>	HF connection cable bipo; L 3 m	8108.032	
		HF connection cable bipo; L 5 m	8108.052	
	 <p>International / 2-pin Valleylab R. Wolf HF surgical generator 400 kHz 2260001/2260002</p>	HF connection cable bipo; L 3 m	8108.033	
		HF connection cable bipo; L 5 m	8108.053	
	 <p>WOLF/Martin (M-version)/ Berchtold/Aesculap</p>	HF connection cable bipo; L 3 m	8108.031	
		HF connection cable bipo; L 5 m	8108.051	
	 <p>EMC Dolley</p>	HF connection cable bipo; L 3 m	8108035	
	<p>Bipolar tweezers connection</p> 	 <p>ERBE (ACC/ICC/T)/BOWA (EU) R. Wolf HF surgical generator 400 kHz 2260001/2260002</p>	HF connection cable bipo; L 3 m	8108.132
			HF connection cable bipo; L 5 m	8108.152
 <p>International / 2-pin Valleylab R. Wolf HF surgical generator 400 kHz 2260001/2260002</p>		HF connection cable bipo; L 3 m	8108.133	
		HF connection cable bipo; L 5 m	8108.153	
 <p>Martin (M-version)/Berchtold/ Aesculap</p>		HF connection cable bipo; L 3 m	8108.131	
		HF connection cable bipo; L 5 m	8108.151	
 <p>EMC Dolley</p>		HF connection cable bipo; L 3 m	8108135	

1124|| Subject to modifications. Please note that some products may not be available in all countries. Please always take note of the information that is provided with the product. For more detailed information, please consult with your contact partner or directly with Richard Wolf GmbH.

HF CONNECTION CABLE BIPO FOR RESECTION IN SALINE SOLUTION

Instrument connector	Device connector		Product no.
<p>WOLF Bipolar resectoscopes</p> 	 Erbe VIO 300D	<p>Bipolar cable; TUR/TCR; WOLF MF plug; L 4 m</p>	<p>20196-119</p>
	 Erbe VIO 3	<p>BIPOLAR CABLE; MF-U MF plug; L 4.5 m</p>	<p>21196-119</p>
	 KLS Martin	<p>HF connection cable bipo; L 3 m</p>	<p>8108.231</p>
	 KLS Martin	<p>HF connection cable bipo; L 5 m</p>	<p>8108.251</p>
	 R. Wolf HF surgical generator 400 kHz 2260001/2260002	<p>HF connection cable bipo; L 3 m</p>	<p>8108233</p>
	 R. Wolf HF surgical generator 400 kHz 2260001/2260002	<p>HF connection cable bipo; L 5 m</p>	<p>8108253</p>

MONO HF NEUTRAL ELECTRODE CABLE

Instrument connector	Device connector		Product no.
<p>2-pole neutral electrode</p> 	 <p>R. Wolf HF surgical generator 400 kHz 2260001/2260002</p>	<p>Mono HF neutral electrode cable, L 4.5 m</p>	<p>2260031</p>

1124|| Subject to modifications. Please note that some products may not be available in all countries. Please always take note of the information that is provided with the product. For more detailed information, please consult with your contact partner or directly with Richard Wolf GmbH.

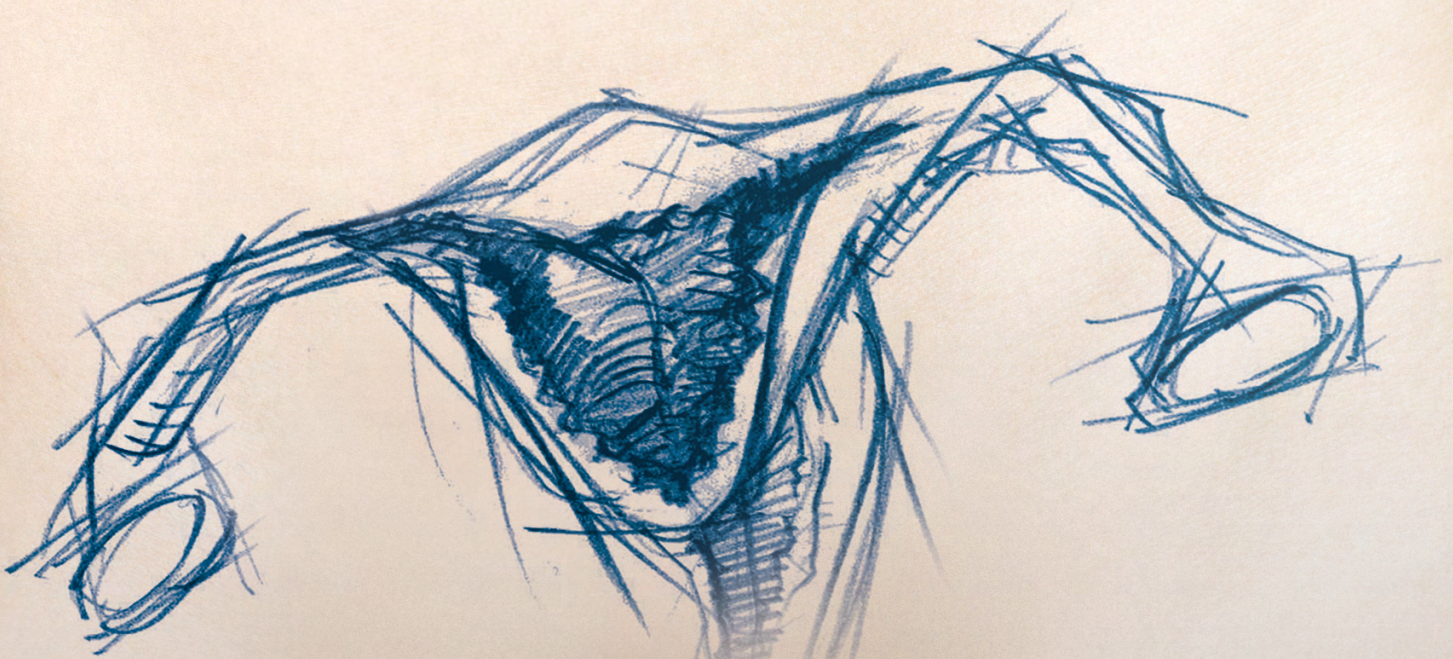

INTERDISCIPLINARY APPLICATIONS

CYSTO-URETHROSCOPY

INTERDISCIPLINARY APPLICATIONS

1

CYSTO-URETHROSCOPE 8650 FOR TELESCOPE 4 MM, 0°, 5°, 30°, 70° (TVT)

2

ATRAUMATIC COMPACT CYSTO-URETHROSCOPE

CYSTO-URETHROSCOPE 8650

E-line

FOR TELESCOPE 4 MM, 0°, 12°, 30°, 70° AND ADAPTERS

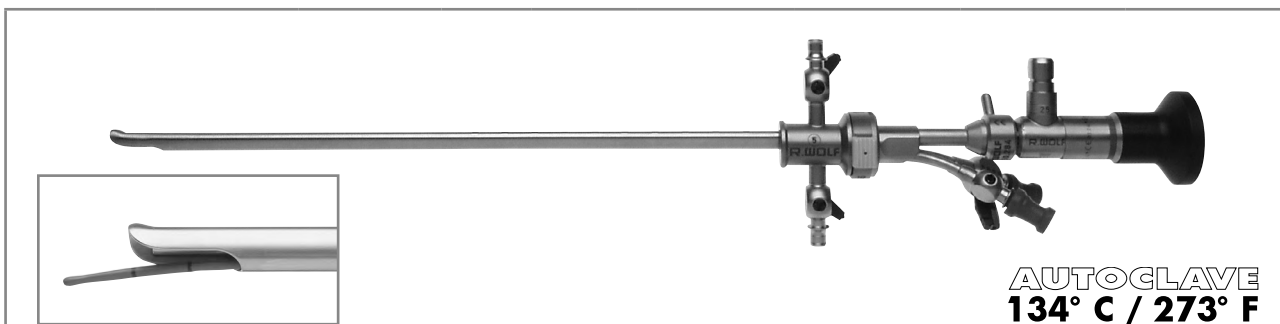

Sheaths and obturators						Adapters		
------------------------	--	--	--	--	--	----------	--	--



Sheath for cystoscope with obturator	Sheath for cystoscope single	Obturator for cystoscope single	Fr	Color coding	Capacity in Fr	Adapter for cystoscope TL 60 mm	Adapter for cystoscope TL 60 mm	Adapter for cystoscope TL 60 mm
8650.0141	8650.0145	8650.0147	16 Fr	yellow	1x5*	8650.254	8650.264	8650.284
8650.0241	8650.0245	8650.0247	17.5 Fr	green	1x5 oder 2x4			
8650.0341	8650.0345	8650.0347	19.5 Fr	red	1x7 oder 2x5			
8650.0441	8650.0445	8650.0447	21 Fr	blue	1x10 oder 2x6			
8650.0541	8650.0545	8650.0547	23 Fr	white	1x12 oder 2x7			
8650.0641	8650.0645	8650.0647	25 Fr	black	1x5			

also:



	Direction of view	Ø	WL	TL	Product no.
Telescope 0° Ø 4 mm NL 298 mm	0°	4 mm	298 mm	365 mm	8650.414
Telescope 12° Ø 4 mm NL 297 mm	12°		297 mm	363 mm	8654.431
Telescope 30° Ø 4 mm NL 300 mm	30°		300 mm	364 mm	8654.422
Telescope 70° Ø 4 mm NL 302 mm	70°		302 mm	364 mm	8650.415

Recommended accessories	Product no.
-------------------------	-------------

Perforated basket for standard telescope 2	Internal dimensions (W x H x D): 454 x 52 x 40 mm External dimensions (W x H x D): 481 x 54 x 59 mm	38016
Fiber light cable bndl consisting of: Fiber light cable (80662523), projector-side adapter (8095.07), and endoscope-side adapter (809509)	Ø 2.5 mm, 2.3 m long	806625231

||24|| Subject to modifications. Please note that some products may not be available in all countries. Please always take note of the information that is provided with the product. For more detailed information, please consult with your contact partner or directly with Richard Wolf GmbH.



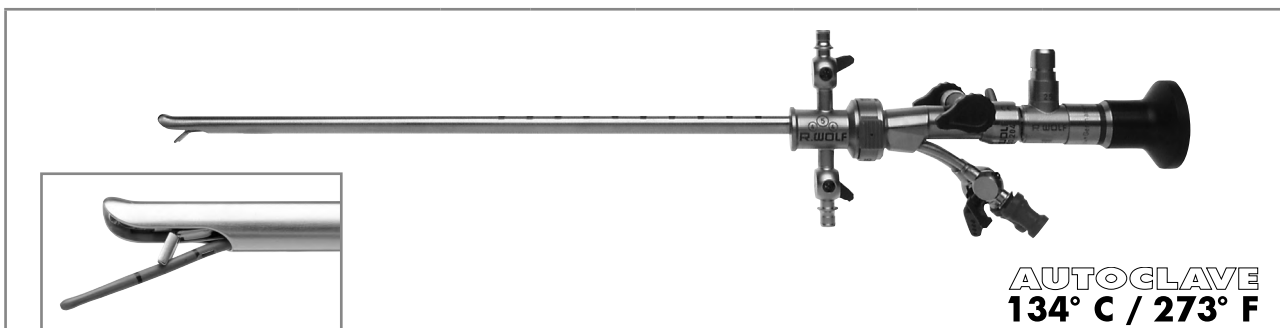

CYSTO-URETHROSCOPE 8650

E-line

FOR TELESCOPE 4 MM, 30°, 70° AND INSERTS WITH ALBARRAN LEVER



AUTOGLAVE
134° C / 273° F

Sheaths and obturators						Inserts with Albarran lever	
							
						1 instrument port	2 instrument ports
Sheath for cystoscope with obturator	Sheath for cystoscope single	Obturator for cystoscope single	Fr	Color coding	Capacity in Fr	Working insert for cystoscope 30/70	Working insert for cystoscope 0/30/70
8650.0241	8650.0245	8650.0247	17.5 Fr	yellow	1 x 5 or 2 x 4	8650.214	8650.204
8650.0341	8650.0345	8650.0347	19.5 Fr	green	1 x 7 or 2 x 5		
8650.0441	8650.0445	8650.0447	21 Fr	red	1 x 10 or 2 x 6		
8650.0541	8650.0545	8650.0547	23 Fr	blue	1 x 12 or 2 x 7		
also: 							
			Direction of view	Ø	WL	TL	Product no.
Telescope 30° Ø 4 mm NL 300 mm			30°	4 mm	300 mm	364 mm	8654.422
Telescope 70° Ø 4 mm NL 302 mm			70°	4 mm	302 mm	364 mm	8650.415

Recommended accessories	Product no.
Perforated basket for standard telescope 2	Internal dimensions (W x H x D): 454 x 52 x 40 mm External dimensions (W x H x D): 481 x 54 x 59 mm 38016
Fiber light cable bndl consisting of: Fiber light cable (80662523), projector-side adapter (8095.07), and endoscope-side adapter (809509)	Ø 2.5 mm, 2.3 m long 806625231

11241 Subject to modifications. Please note that some products may not be available in all countries. Please always take note of the information that is provided with the product. For more detailed information, please consult with your contact partner or directly with Richard Wolf GmbH.





ATRAUMATIC COMPACT CYSTO-URETHROSCOPE

14/17 FR, 25° AND ADAPTERS



	Viewing direction	WL	TL	Sheath	Working channel		Product no.
					for auxiliary instruments	Form	
Cystoscope 25°, 14 Fr, WL 218 mm with straight eyepiece, atraumatically shaped tip	25°	218 mm	358 mm	14 Fr	to 5 Fr	oval	8642.403
Cystoscope 25°, 17 Fr, WL 224 mm with straight eyepiece, atraumatically shaped tip	25°	224 mm	364 mm	17 Fr	to 7 Fr	oval	8645.403

also:

		WL	TL	Fr	Product no.
	Flex. biopsy forceps 7 Fr WL 375 mm	375 mm	490 mm	7	829.07
	Flex. biopsy forceps 5 Fr WL 315 mm	315 mm	465 mm	5	829.05
	Flex. grasping forceps 7 Fr WL 365 mm	365 mm	515 mm	7	828.07
	Flex. grasping forceps 5 Fr WL 315 mm	315 mm	465 mm	5	828.05
	Flex. scissors 7 Fr WL 375 mm	375 mm	490 mm	7	830.07
	Coagulation electrode mono 6 Fr WL 400 mm	400 mm	-	6	823.06
	Coagulation electrode mono 5 Fr WL 400 mm	400 mm	-	5	823.05

Recommended accessories

Product no.

Perforated basket for cysto-urethroscope	Internal dimensions (W x H x D): 435 x 54 x 73 mm External dimensions (W x H x D): 451 x 64 x 80 mm	38013
Fiber light cable bndl consisting of: Fiber light cable (80662523), projector-side adapter (8095.07), and endoscope-side adapter (809509)	Ø 2.5 mm, 2.3 m long	806625231

