

UROLOGY

UROLOGY

1

LOWER URINARY TRACT

2

UPPER URINARY TRACT

3

PEDIATRIC UROLOGY

4

AUXILIARY INSTRUMENTS

5

LAPAROSCOPY

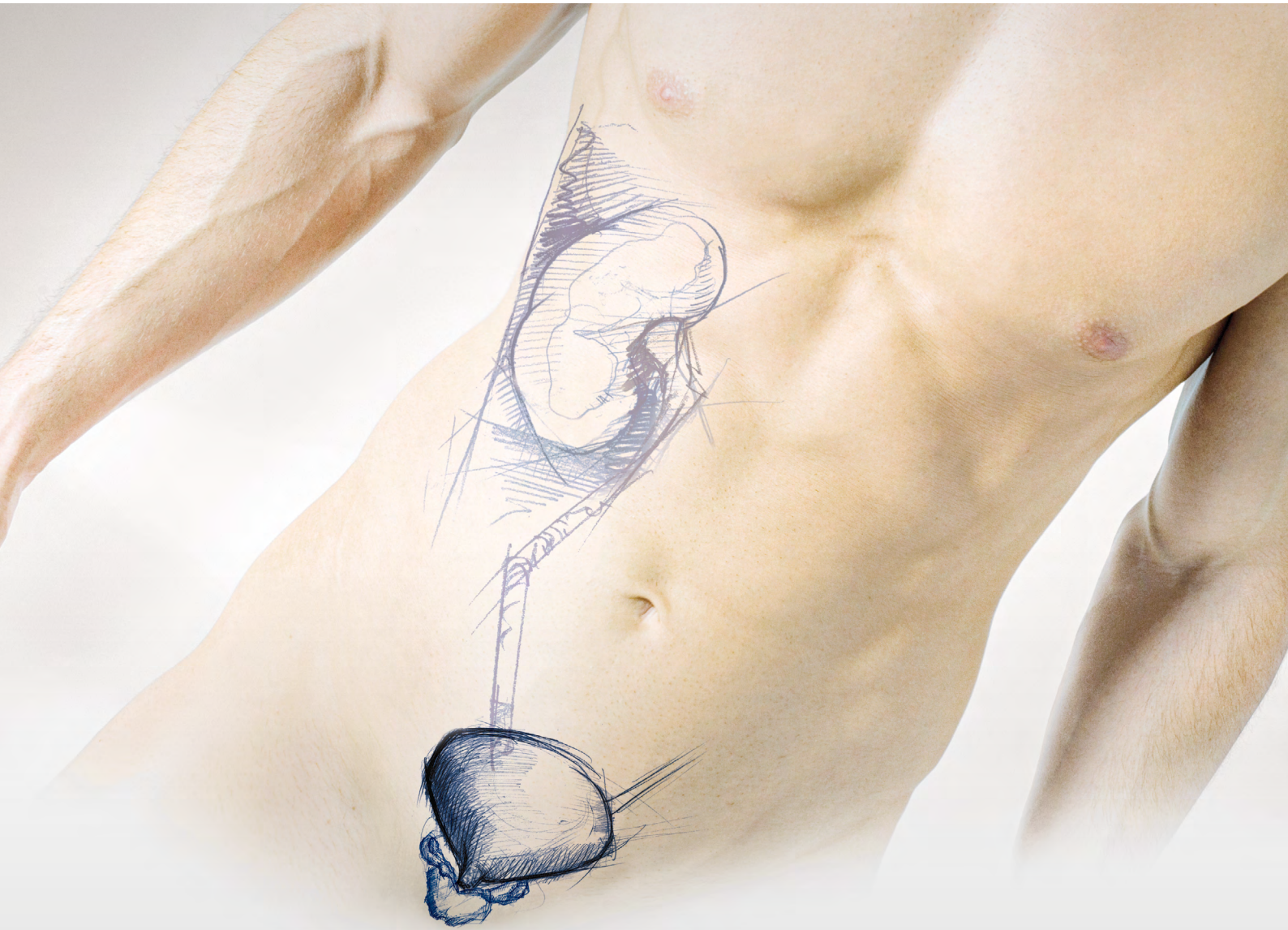

LOWER URINARY TRACT

LOWER URINARY TRACT

1.1

BASIC SETS/OVERVIEW OF PANOVVIEW TELESCOPES

URETHROTOMY

1.2

OPTICAL URETHROTOMES

1.3

URETHROTOME FOR BLIND SLITTING

CYSTOSCOPY

1.4

CYSTO-URETHROSCOPE 8650

1.5

"MIDI-SIZE" CYSTO-URETHROSCOPE

1.6

ATRAUMATIC COMPACT CYSTO-URETHROSCOPE

1.7

FLEXIBLE FIBER CYSTOSCOPE

1.8

"VISION EF" FLEXIBLE SENSOR CYSTOSCOPES

1.9

"MAMBA" FLEXIBLE SENSOR CYSTOSCOPES

1.10

"SYSTEM BLUE" FOR PHOTODYNAMIC DIAGNOSTICS (PDD)

TRANSURETHRAL RESECTION (TUR)

1.11

"SHARK" RESECTOSCOPES (MONOPOLAR/BIPOLAR)

1.12

"E-LINE" RESECTOSCOPE, LONG SHEATH

1.13

"MIDI-SIZE" RESECTOSCOPE

1.14

"SYSTEM BLUE" FOR PHOTODYNAMIC DIAGNOSTICS (PDD)

1.15

"SHARK" ELECTRODES (MONOPOLAR/BIPOLAR) – "E-LINE" ELECTRODES

1.16

ACCESSORIES FOR RESECTOSCOPE SHEATHS

LOWER URINARY TRACT

ANATOMIC ENDOSCOPIC ENUCLEATION OF THE PROSTATE (AEEP)	
LASER ENUCLEATION (HoLEP/ThuLEP/GreenLEP)	1.17
BIPOLAR ENUCLEATION (BipoLEP)	1.18
MORCELLATION	
"SHARK" MORCESCOPE	1.19
"PIRANHA" MORCELLATION SYSTEM	1.20
LASER ENERGY SOURCES	
"MEGA PULSE 70+" HOLMIUM:YAG LASER (Ho:YAG)	1.21
"PULVIS 60+" THULIUM FIBER LASER (TFL)	1.22
HF ENERGY SOURCES	
HF GENERATOR 2260	1.23
HF CONNECTION CABLE	1.24
SUCTION IRRIGATION PUMP	
FLUID CONTROL 2225	1.25

BASIC EQUIPMENT FOR CYSTOSCOPY

E-line CYSTO-URETHROSCOPES 8650

Product	Product no.	Quantity	Catalog/Section
Endoscopes and instruments			
Sheath for cystoscope 19.5 Fr	8650.0341	1	Urology/Cystoscopes
Adapter for cystoscope	8650.264	1	
Working insert for cystoscope 0/30/70	8650.204	1	
Universal sealing valve 1–6 Fr	4712348	1	
Viewing obturator for cystoscope 19.5 Fr	8650.724	1	
Opt. biopsy forceps, "Marburg" model	8650.614	1	
Opt. grasping forceps, straight	8650.684	1	
Telescope 0° Ø 4 mm WL 298 mm	8650.414	1	
Telescope 70° Ø 4 mm WL 302 mm	8650.415	1	
Urethrotome 15–45 Fr WL 236 mm	8517.00	1	
Bladder syringe 150 ml Ø 54 mm	822.31	1	
Flexible adapter for bladder syringe	822.13	1	
Perforated basket for standard telescope 2	38016	1	Hygiene
Container (W x H x D) 400 x 60 x 200 mm	33022	1	

BASIC EQUIPMENT FOR TUR

Shark RESECTOSCOPE, MONOPOLAR
TELESCOPE 4 MM, 12°/30°
24/26 Fr, ACTIVE, CONTINUOUS IRRIGATION

Product	Product no.	Quantity	Catalog/Section
Endoscopes and instruments			
Outer sheath for resectoscope 26 Fr	8675426	1	Urology/Resectoscopes
Inner sheath for resectoscope 24 Fr	8675324	1	
Dilatations obturator f. resectoscope 24 Fr	8673224	1	
Obturator for resectoscope 24 Fr	8673024	1	
Viewing obturator for resectoscope 24 Fr	8673124	1	
Working element, active, bipo 0/12/30°	8680.205	1	
Telescope 12° Ø 4 mm WL 297 mm	8654.431	1	
Telescope blue 12° Ø 4 mm WL 298 mm	8654.531	1	
Telescope 30° Ø 4 mm WL 300 mm	8654.422	1	
Telescope blue 30° Ø 4 mm WL 299 mm	8654.522	1	
Cutting electrode mono 24 Fr 12/30°	46782435	1	
Coag. electrode mono 22–24 Fr 12/30°	46782201	1	
Protective sterilization sleeve	33030	1	
HF monopolar connection cable	see URO103/104	1	
Urethrotome 15–45 Fr WL 236 mm	8517.00	1	Urology/Urethrotomes
Knife for urethrotome	8517.90	1	
Irrigation pump for HYS/URO/LAP bndI	22250011	1	Urology/Resectoscopes
Bladder syringe 150 ml Ø 54 mm	822.31	1	Urology/Auxiliary instruments
Flexible adapter for bladder syringe	822.13	1	

BASIC EQUIPMENT FOR TUR

Shark RESECTOSCOPE, MONOPOLAR

TELESCOPE 4 MM, 0°

24 Fr, PASSIVE, INTERMITTENT IRRIGATION WITH CENTRAL STOPCOCK

Product	Product no.	Quantity	Catalog/Section
Endoscopes and instruments			
Sheath for resectoscope 24 Fr	8676424	1	Urology/Resectoscopes
Connection part for resectoscope 24 Fr	8676342	1	
Dilatations obturator f. resectoscope 24 Fr	8673224	1	
Viewing obturator for resectoscope 24 Fr	8673124	1	
Obturator for resectoscope 24 Fr	8673024	1	
Working element, passive, mono 0°	8681224	1	
Telescope 0° Ø 4 mm WL 298 mm	8650.414	1	
Telescope blue 0° Ø 4 mm WL 298 mm	8650.514	1	
Cutting electrode mono 24 Fr 0°	46792435	1	
Protective sterilization sleeve	33030	1	
HF monopolar connection cable	see UR0103/104	1	
Urethrotome 15–45 Fr WL 236 mm	8517.00	1	Urology/Urethrotomes
Knife for urethrotome	8517.90	1	
Bladder syringe 150 ml Ø 54 mm	822.31	1	Urology/Auxiliary instruments
Flexible adapter for bladder syringe	822.13	1	

BASIC EQUIPMENT FOR TUR

 RESECTOSCOPE, MONOPOLAR

TELESCOPE 4 MM, 0°

24 Fr, PASSIVE, INTERMITTENT IRRIGATION WITH ROTATABL IRRIGATION ADAPTER

Product	Product no.	Quantity	Catalog/Section
Endoscopes and instruments			
Sheath for resectoscope 24 Fr	8676324	1	Urology/Resectoscopes
Irrigation adapter for resectoscope 24/26 Fr with 4 mm Luer connection	8676354	1	
Irrigation adapter for resectoscope 24/26 Fr with 3 mm Luer connection with stopcock	8676361	1	
Two-way stopcock, maintenance-free	88351	1	
Dilations obturator f. resectoscope 24 Fr	8673224	1	
Viewing obturator for resectoscope 24 Fr	8673124	1	
Obturator for resectoscope 24 Fr	8673024	1	
Working element, passive, mono 0°	8681224	1	
Telescope 0° Ø 4 mm WL 298 mm	8650.414	1	
Telescope blue 0° Ø 4 mm WL 298 mm	8650.514	1	
Cutting electrode mono 24 Fr 0°	46792435	1	
Protective sterilization sleeve	33030	1	
HF monopolar connection cable	see URO103/104	1	
Urethrotome 15–45 Fr WL 236 mm	8517.00	1	Urology/Urethrotomes
Knife for urethrotome	8517.90	1	
Bladder syringe 150 ml Ø 54 mm	822.31	1	Urology/Auxiliary instruments
Flexible adapter for bladder syringe	822.13	1	

BASIC EQUIPMENT FOR TUR

Shark RESECTOSCOPE, BIPOLAR
TELESCOPE 4 MM, 12°/30°
22/24 Fr, ACTIVE, CONTINUOUS IRRIGATION

Product	Product no.	Quantity	Catalog/Section
Endoscopes and instruments			
Outer sheath for resectoscope 24 Fr	8675424	1	Urology/Resectoscopes
Inner sheath for resectoscope 22 Fr	8675322	1	
Viewing obturator for resectoscope 22 Fr	8673122	1	
Obturator for resectoscope 22 Fr	8673022	1	
Working element, active, bipo 0/12/30°	8680.205	1	
Telescope 12° Ø 4 mm WL 297 mm	8654.431	1	
Telescope blue 12° Ø 4 mm WL 298 mm	8654.531	1	
Telescope 30° Ø 4 mm WL 300 mm	8654.422	1	
Telescope blue 30° Ø 4 mm WL 299 mm	8654.522	1	
Cutting electrode bipo 22 Fr 12/30°	4622.1333	1	
Coag. electrode bipo 22 Fr 12/30°	4623.0243	1	
BiVAP-Elektrode bipo 22 Fr 12/30°	46300223	1	
HF bipolar connection cable	see URO105	1	
Urethrotome 15–45 Fr WL 236 mm	8517.00	1	Urology/Urethrotomes
Knife for urethrotome	8517.90	1	
Irrigation pump for HYS/URO/LAP bndI	22250011	1	Urology/Resectoscopes
Bladder syringe 150 ml Ø 54 mm	822.31	1	Urology/Auxiliary instruments
Flexible adapter for bladder syringe	822.13	1	

BASIC EQUIPMENT FOR TUR

Shark RESECTOSCOPE, BIPOLAR
 TELESCOPE 4 MM, 12°/30°
 24/26 Fr, ACTIVE, CONTINUOUS IRRIGATION

Product	Product no.	Quantity	Catalog/Section
Endoscopes and instruments			
Outer sheath for resectoscope 26 Fr	8675426	1	Urology/Resectoscopes
Inner sheath for resectoscope 24 Fr	8675324	1	
Dilatations obturator f. resectoscope 24 Fr	8673224	1	
Obturator for resectoscope 24 Fr	8673024	1	
Viewing obturator for resectoscope 24 Fr	8673124	1	
Working element, active, bipo 0/12/30°	8680.205	1	
Telescope 12° Ø 4 mm WL 297 mm	8654.431	1	
Telescope blue 12° Ø 4 mm WL 298 mm	8654.531	1	
Telescope 30° Ø 4 mm WL 300 mm	8654.422	1	
Telescope blue 30° Ø 4 mm WL 299 mm	8654.522	1	
Coag. electrode bipo 22 Fr 12/30°	4623.0243	1	
BiVAP-Elektrode bipo 22 Fr 12/30°	46300223	1	
BiVAP-Elektrode bipo 24–26 Fr 12/30°	46300243	1	
HF bipolar connection cable	see URO105	1	
Urethrotome 15–45 Fr WL 236 mm	8517.00	1	Urology/Urethrotomes
Knife for urethrotome	8517.90	1	
Irrigation pump for HYS/URO/LAP bndI	22250011	1	Urology/Resectoscopes
Bladder syringe 150 ml Ø 54 mm	822.31	1	Urology/Auxiliary instruments
Flexible adapter for bladder syringe	822.13	1	

BASIC EQUIPMENT FOR TUR

Shark RESECTOSCOPE, BIPOLAR

TELESCOPE 4 MM, 12°

24 Fr, ACTIVE, INTERMITTENT IRRIGATION WITH CENTRAL STOPCOCK

Product	Product no.	Quantity	Catalog/Section
Endoscopes and instruments			
Outer sheath for resectoscope 26 Fr	8675426	1	Urology/Resectoscopes
Inner sheath for resectoscope 24 Fr	8675324	1	
Dilatations obturator f. resectoscope 24 Fr	8673224	1	
Obturator for resectoscope 24 Fr	8673024	1	
Viewing obturator for resectoscope 24 Fr	8673124	1	
Working element, active, bipo 0/12/30°	8680.205	1	
Telescope 12° Ø 4 mm WL 297 mm	8654.431	1	
Telescope blue 12° Ø 4 mm WL 298 mm	8654.531	1	
Coag. electrode bipo 22 Fr 12/30°	4623.0243	1	
BiVAP-Elektrode bipo 22 Fr 12/30°	46300223	1	
BiVAP-Elektrode bipo 24–26 Fr 12/30°	46300243	1	
HF bipolar connection cable	see URO105	1	Urology/Urethrotomes
Urethrotome 15–45 Fr WL 236 mm	8517.00	1	
Knife for urethrotome	8517.90	1	Urology/Auxiliary instruments
Irrigation pump for HYS/URO/LAP bndI	22250011	1	
Bladder syringe 150 ml Ø 54 mm	822.31	1	
Flexible adapter for bladder syringe	822.13	1	



HoLEP, ThuLEP

BASIC LASER ENUCLEATION SET I

STANDARD LASER RESECTOSCOPE 24/26 Fr

Product	Product no.	Quantity	Catalog/Section
"PIRANHA" morcellator			
Suction pump	2208001	1	Urology/Laser enucleation
1-pedal footswitch	2030108	1	
Bottle holder	64031.381	1	
Sound absorber (Pack= 3 PCS)	35100.115	1	
RECTO PUMP connection tube	8170.6554	1	
Overflow protection/bacteria filter (Pack = 10 PCS)	2228.901	1	
Secretion container, 2 l, without cover	8170.6551	1	
Cover for secretion trap 8170.6551, reusable	8170.6552	1	
Optional: 3 L suction jar for RCS	077.0130		
Power cable, cable length 3 m	2440.03	1	
Tube for suction	41702208	1	
Collecting container	2208120	1	
Motor Control Unit 2303	2303.001	1	
Also: Power cable, cable length 3 m	2440.03	1	
Motor handpiece max. 6,000 rpm	8564122	1	
Irrigation adapter for motor handpiece 8564.021	163951		
Rotary morcellator Ø 4.8 mm WL 335 mm	49700113	1	
Rotary morcellator Ø 4.8 mm WL 385 mm for morcellator telescopes <i>from other manufacturers</i>	49700103	1	
Laser resectoscope 24/26 Fr			
Telescope 30° Ø 4 mm WL 300 mm	8654.422	1	Urology/Laser enucleation
Telescope 12° Ø 4 mm WL 297 mm	8654.431	1	
Also: Fiber light cable bndl, Ø 2.5 mm, 2.3 m long	806625231	1	
for reprocessing: Perforated basket for standard telescope 2	38016	1	
Laser working element, passive 12/30°	8654382	1	
Alternative: Laser working insert 12/30°	8654383	1	
Guide tube laser therapy 1,000 µm 24 Fr	8654991	1	
Guide tube laser therapy 600 µm 24 Fr	8654993	1	
Guide tube laser therapy 600 µm 24 Fr	8654995	1	
Guide tube laser therapy 600 µm 24 Fr	8654997	1	
Curette 22–24 Fr for prostate chips	8654998	1	

IX23|| Subject to modifications. Please note that some products may not be available in all countries. Please always take note of the information that is provided with the product. For more detailed information, please consult with your contact partner or directly with Richard Wolf GmbH.



HoLEP, ThuLEP
BASIC LASER ENUCLEATION SET I
 STANDARD LASER RESECTOSCOPE 24/26 Fr

Product	Product no.	Quantity	Catalog/Section
Laser resectoscope 24/26 Fr			
Outer sheath for resectoscope 26 Fr	8675426	1	Urology/Laser enucleation
Inner sheath for resectoscope 24 Fr	8675324	1	
Obturator for resectoscope 24 Fr	8673024	1	
Viewing obturator for resectoscope 24 Fr	8673124	1	
Dilatations obturator f. resectoscope 24 Fr	8673224	1	
MORCESCOPE			
Morcescope 0° 24 Fr WL 199 mm	8970407	1	Urology/Laser enucleation
Autom. sealing element ID 5.7 mm	8920.311	1	
Pressure ball	103.00	1	
Tube with LUER-LOCK connector	886.00	1	
Cleaning brush Ø 11 mm TL 360 mm	6.01	1	
Also:			
Fiber light cable bndl Ø 3.5 mm, 2.3 m long	806635231	1	
Perforated basket for Morcescope with small part basket	38012	1	

IX23 || Subject to modifications. Please note that some products may not be available in all countries. Please always take note of the information that is provided with the product. For more detailed information, please consult with your contact partner or directly with Richard Wolf GmbH.



HOLEP, THULEP

BASIC LASER ENUCLEATION SET II

LASER ENUCLEATION SHEATH FOR **BLUNT** ENUCLEATION 24/26 Fr

Product	Product no.	Quantity	Catalog/Section
"PIRANHA" morcellator			
Suction pump	2208001	1	Urology/Laser enucleation
1-pedal footswitch	2030108	1	
Bottle holder	64031.381	1	
Sound absorber (Pack= 3 PCS)	35100.115	1	
RECTO PUMP connection tube	8170.6554	1	
Overflow protection/bacteria filter (Pack = 10 PCS)	2228.901	1	
Secretion container, 2 l, without cover	8170.6551	1	
Cover for secretion trap 8170.6551, reusable	8170.6552	1	
Optional: 3 L suction jar for RCS	077.0130		
Power cable, cable length 3 m	2440.03	1	
Tube for suction	41702208	1	
Collecting container	2208120	1	
Motor Control Unit 2303	2303.001	1	
Also: Power cable, cable length 3 m	2440.03	1	
Motor handpiece max. 6,000 rpm	8564122	1	
Irrigation adapter for motor handpiece 8564.021	163951		
Rotary morcellator Ø 4.8 mm WL 335 mm	49700113	1	
Rotary morcellator Ø 4.8 mm WL 385 mm for morcellator telescopes <i>from other manufacturers</i>	49700103	1	
Laser resectoscope 24/26 Fr			
Telescope 30° Ø 4 mm WL 300 mm	8654.422	1	Urology/Laser enucleation
Telescope 12° Ø 4 mm WL 297 mm	8654.431	1	
Also: Fiber light cable bndl, Ø 2.5 mm, 2.3 m long	806625231	1	
for reprocessing: Perforated basket for standard telescope 2	38016	1	
Laser working element, passive 12/30°	8654382	1	
Alternative: Laser working insert 12/30°	8654383	1	
Guide tube laser therapy 1,000 µm 24 Fr	8654991	1	
Guide tube laser therapy 600 µm 24 Fr	8654993	1	
Guide tube laser therapy 600 µm 24 Fr	8654995	1	
Guide tube laser therapy 600 µm 24 Fr	8654997	1	
Curette 22–24 Fr for prostate chips	8654998	1	



HOLEP, THULEP
 BASIC LASER ENUCLEATION SET II
 LASER ENUCLEATION SHEATH FOR **BLUNT** ENUCLEATION

Product	Product no.	Quantity	Catalog/Section
Laser enucleation sheath for blunt enucleation 24/26 Fr			
Outer sheath for resectoscope 26 Fr	8675426	1	Urology/Laser enucleation
Inner sheath for laser therapy 24 Fr	8675524	1	
Obturator for resectoscope 24 Fr	8673324	1	
Alternative:			
Outer sheath for resectoscope 26 Fr	8675426	1	
Inner sheath for resectoscope 24 Fr	8675324	1	
Obturator for resectoscope 24 Fr	8673024	1	
Dilatations obturator f. resectoscope 24 Fr	8673224	1	
MORCESCOPE			
Morcescope 0° 24 Fr WL 199 mm	8970407	1	Urology/Laser enucleation
Autom. sealing element ID 5.7 mm	8920.311	1	
Pressure ball	103.00	1	
Tube with LUER-LOCK connector	886.00	1	
Cleaning brush Ø 11 mm TL 360 mm	6.01	1	
Also:			
Fiber light cable bndl Ø 3.5 mm, 2.3 m long	806635231	1	
Perforated basket for Morcescope with small part basket	38012	1	

IX23 || Subject to modifications. Please note that some products may not be available in all countries. Please always take note of the information that is provided with the product. For more detailed information, please consult with your contact partner or directly with Richard Wolf GmbH.



HOLEP, THULEP

BASIC LASER ENUCLEATION SET III

STANDARD LASER RESECTOSCOPE 24/26 Fr AND BIPOLAR RESECTION

Product	Product no.	Quantity	Catalog/Section
"PIRANHA" morcellator			
Suction pump	2208001	1	Urology/Laser enucleation
1-pedal footswitch	2030108	1	
Bottle holder	64031.381	1	
Sound absorber (Pack= 3 PCS)	35100.115	1	
RECTO PUMP connection tube	8170.6554	1	
Overflow protection/bacteria filter (Pack = 10 PCS)	2228.901	1	
Secretion container, 2 l, without cover	8170.6551	1	
Cover for secretion trap 8170.6551, reusable	8170.6552	1	
Optional: 3 L suction jar for RCS	077.0130		
Power cable, cable length 3 m	2440.03	1	
Tube for suction	41702208	1	
Collecting container	2208120	1	
Motor Control Unit 2303	2303.001	1	
Also: Power cable, cable length 3 m	2440.03	1	
Motor handpiece max. 6,000 rpm	8564122	1	
Irrigation adapter for motor handpiece 8564.021	163951		
Rotary morcellator Ø 4.8 mm WL 335 mm	49700113	1	
Rotary morcellator Ø 4.8 mm WL 385 mm for morcellator telescopes from other manufacturers	49700103	1	
Laser resectoscope 24/26 Fr			
Telescope 30° Ø 4 mm WL 300 mm	8654.422	1	Urology/Laser enucleation
Telescope 12° Ø 4 mm WL 297 mm	8654.431	1	
Also: Fiber light cable bndl, Ø 2.5 mm, 2.3 m long	806625231	1	
for reprocessing: Perforated basket for standard telescope 2	38016	1	
Laser working element, passive 12/30°	8654382	1	
Alternative: Laser working insert 12/30°	8654383	1	
Guide tube laser therapy 1,000 µm 24 Fr	8654991	1	
Guide tube laser therapy 600 µm 24 Fr	8654993	1	
Guide tube laser therapy 600 µm 24 Fr	8654995	1	
Guide tube laser therapy 600 µm 24 Fr	8654997	1	
Curette 22–24 Fr for prostate chips	8654998	1	

IX23|| Subject to modifications. Please note that some products may not be available in all countries. Please always take note of the information that is provided with the product. For more detailed information, please consult with your contact partner or directly with Richard Wolf GmbH.



HOLEP, THULEP

BASIC LASER ENUCLEATION SET III

STANDARD LASER RESECTOSCOPE 24/26 Fr AND BIPOLAR RESECTION



spirit of excellence

BASIC SETS

1.1

Product	Product no.	Quantity	Catalog/Section
Laser resectoscope 24/26 Fr			
Outer sheath for resectoscope 26 Fr	8675426	1	Urology/Laser enucleation
Inner sheath for resectoscope 24 Fr	8675324	1	
Obturator for resectoscope 24 Fr	8673024	1	
Viewing obturator for resectoscope 24 Fr	8673124	1	
Dilatations obturator f. resectoscope 24 Fr	8673224	1	
Bipolar resectoscope 24/26 Fr			
Working element, active, bipo 0/12/30	8680.205	1	Urology/Laser enucleation
Optional: working element, passive, bipo 0/12/30°	8680.225	1	
Cutting electrode bipo 24 Fr 12/30°	4622.1313	1	
Coag. electrode bipo 24–26 Fr 12/30°	4623.0223	1	
HF bipolar connection cable L 3 m	8108.232	1	
HF bipolar connection cable L 5 m	8108.252	1	
HF bipolar connection cable L 3 m	8108.231	1	
HF bipolar connection cable L 3 m	8108.251	1	
Morcescope			
Morcescope 0° 24 Fr WL 199 mm	8970407	1	Urology/Laser enucleation
Autom. sealing element ID 5.7 mm	8920.311	1	
Pressure ball	103.00	1	
Tube with LUER-LOCK connector	886.00	1	
Cleaning brush Ø 11 mm TL 360 mm	6.01	1	
Also:			
Fiber light cable bndl Ø 3.5 mm, 2.3 m long	806635231	1	
Perforated basket for Morcescope with small part basket	38012	1	
Note: Can also be combined with monopolar working elements, electrodes, and HF cables, of course.			

IX23 | Subject to modifications. Please note that some products may not be available in all countries. Please always take note of the information that is provided with the product. For more detailed information, please consult with your contact partner or directly with Richard Wolf GmbH.

TELESCOPES

OVERVIEW

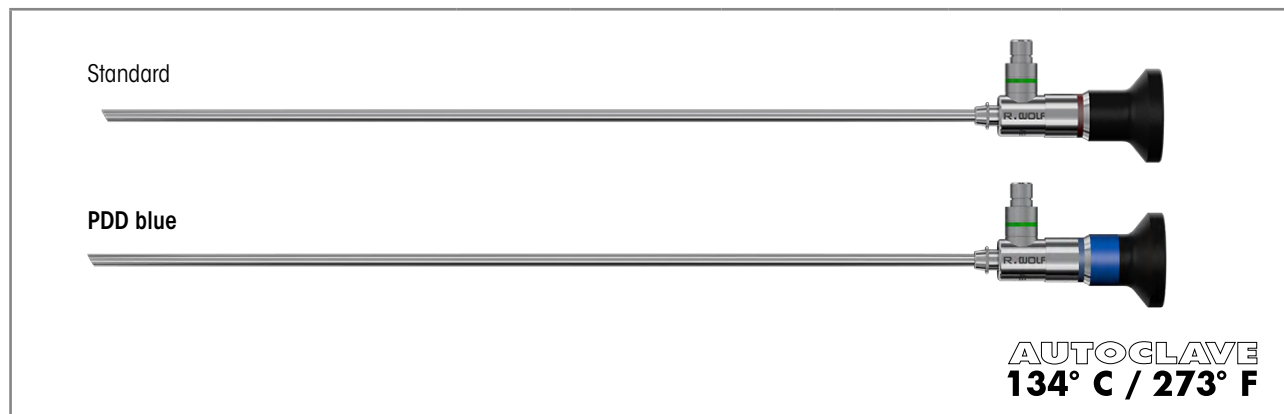

	Direction of view	Color coding	Ø	WL	TL	Product no.
Telescope 0° Ø 4 mm WL 298 mm	0°	Blue	4.0 mm	298 mm	365 mm	8650.414
Telescope blue 0° Ø 4 mm WL 298 mm				298 mm		8650.514**
Telescope 12° Ø 4 mm WL 297 mm	12°	Orange	4.0 mm	297 mm	363 mm	8654.431
Telescope blue 12° Ø 4 mm WL 298 mm				298 mm		8654.531**
Telescope 30° Ø 4 mm WL 300 mm	30°	Red	4.0 mm	300 mm	364 mm	8654.422
Telescope blue 30° Ø 4 mm WL 299 mm				299 mm		8654.522**
Telescope 30° Ø 3.3 mm WL 299 mm				299 mm		8656.422
Telescope 25° Ø 4 mm WL 342 mm	25°		4.0 mm	342 mm	404 mm	8668.433*
Telescope 70° Ø 4 mm WL 302 mm	70°	Yellow	4.0 mm	302 mm	364 mm	8650.415
Telescope blue 70° Ø 4 mm WL 303 mm				303 mm		8650.515**

* Only available in 25°.

** We have adapted our PANOVIEW telescopes to our new, high-performance blue PDD system.

The PANOVIEW telescopes are marked "blue" to distinguish them and they can also be used with your existing PDD system, of course.

Recommended accessories		Product no.
Perforated basket for standard telescope 2	Internal dimensions (W x H x D): 454 x 52 x 40 mm External dimensions (W x H x D): 481 x 54 x 59 mm	38016
Fiber light cable bndl consisting of: Fiber light cable (80662523), projector-side adapter (8095.07), and endoscope-side adapter (809509)	Ø 2.5 mm, 2.3 m long	806625231

OPTICAL URETHROTOME 8667







E-line

FOR TELESCOPE 4 MM, 0°



12 o'clock cutting position

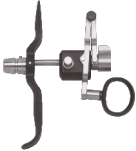
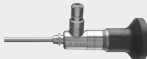







AUTOCLAVE
134° C / 273° F

for optically controlled slitting of urethral strictures.					Product no.
Sheath for urethrotome 20.5 Fr SL 195 mm, with instrument port for lateral catheter insertion (4 Fr)					8667.011
Obturator for urethrotome 20.5 Fr WL 231 mm, oval, cannulated, distal end rounded					8667.111
Outer sheath for urethrotome 20.5 Fr SL 187 mm, oval, laterally open, for placing a 16 Fr balloon catheter					8667.161
Adapter for cystoscope with 1 instrument port, max. capacity 10 Fr, TL 79 mm					8652.264
Working element, urethrotome, passive 0/12° Receptacle for stricture scalpels					8667.911
Also: 					
Telescope	Direction of view	Ø	WL	TL	Product no.
Telescope 0° Ø 4 mm WL 298 mm	0°	4 mm	298 mm	365 mm	8650.414
					
Recommended accessories					Product no.
Perforated basket for standard telescope 2		Internal dimensions (W x H x D): 454 x 52 x 40 mm External dimensions (W x H x D): 481 x 54 x 59 mm			38016
Fiber light cable bndl consisting of: Fiber light cable (80662523), projector-side adapter (8095.07), and endoscope-side adapter (809509)		Ø 2.5 mm, 2.3 m long			806625231
Stricture scalpels					see UR021

IX23 | Subject to modifications. Please note that some products may not be available in all countries. Please always take note of the information that is provided with the product. For more detailed information, please consult with your contact partner or directly with Richard Wolf GmbH.

STRICTURE SCALPELS

FOR OPTICAL URETHROTOME 8667

Stricture scalpels with ceramic cutter		Cutting edge	Product no.
 Solid sheath	Scalpel 20.5 Fr ceramic, semi-circular	Semi-circular	8667.961
 Sheath with central bore hole (for 4 Fr ureteral catheter)	Scalpel 20.5 Fr ceramic, semi-circular	Semi-circular	8667.966
 Sheath with central bore hole (for 4 Fr ureteral catheter)	Scalpel 20.5 Fr ceramic, shark fin	Shark fin for narrow stenoses	8667.971
 Solid sheath	Scalpel 20.5 Fr ceramic, lancet-shaped	Lancet-shaped	8667.981
Stricture scalpels (steel)		Cutting edge	Product no.
 Sheath with central bore hole (for 4 Fr ureteral catheter)	Scalpel 20.5 Fr, semi-circular	Semi-circular	8667.965
 Solid sheath	Scalpel 20.5 Fr, semi-circular	Semi-circular	8667.96
 Solid sheath	Scalpel 20.5 Fr, lancet-shaped	Lancet-shaped	8667.98
 Solid sheath	Scalpel 20.5 Fr, sickle-shaped	Sickle-shaped	8667.93





Recommended accessories		Product no.
Protective sterilization sleeve Receptacle for max. 5 electrodes, reusable	 AUTOCLAVE 134° C / 273° F	33030

OPTICAL MINI URETHROTOME

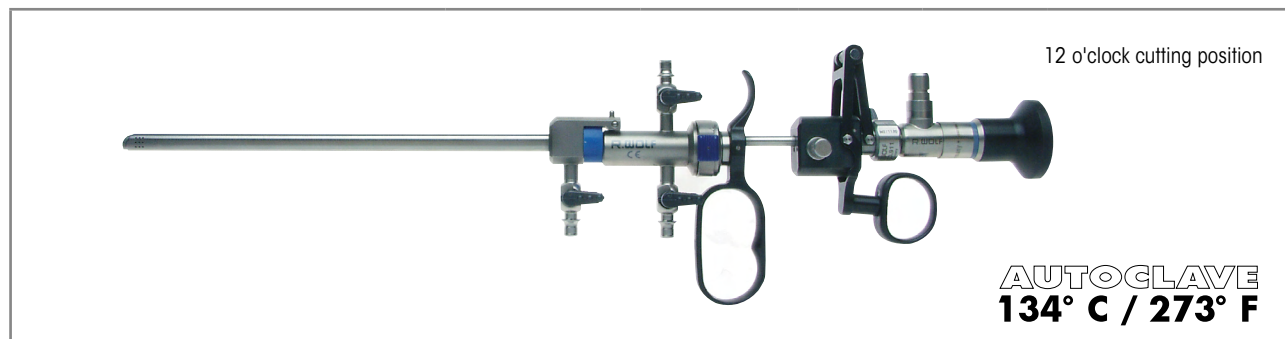
E-line

FOR TELESCOPE 3.3 MM, 0°



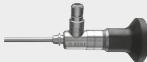

for optically controlled slitting of urethral strictures.					Product no.
Sheath for urethrotome 16.5 Fr with supply and drain stopcock, lateral instrument port (4 Fr), distal end slanted, and automatic lock					8670.011
Obturator for urethrotome 16.5 Fr Oval, cannulated, distal end rounded					8670.111
Outer sheath for urethrotome 16.5 Fr Oval, laterally open, for placing a 16 Fr balloon catheter					8670.061
Outer sheath for urethrotome 16.5 Fr Oval, laterally open, for placing a 12 Fr balloon catheter					8670.161
Working element, urethrotome, passive 0° Receptacle for stricture scalpels					8670.911
Also: 					
Telescope	Direction of view	Ø	WL	TL	Product no.
Telescope 0° Ø 3.3 mm WL 297 mm	0°	3.3 mm	297 mm	362 mm	8660.424



Recommended accessories		Product no.
Perforated basket for standard telescope 2	Internal dimensions (W x H x D): 454 x 52 x 40 mm External dimensions (W x H x D): 481 x 54 x 59 mm	38016
Fiber light cable bndl consisting of: Fiber light cable (80662523), projector-side adapter (8095.07), and endoscope-side adapter (809509)	Ø 2.5 mm, 2.3 m long	806625231
Stricture scalpels		see URO23

STRICTURE SCALPELS

FOR OPTICAL MINI URETHROTOME 8670

Stricture scalpels with ceramic cutter		Cutting edge	Product no.
 Solid sheath	Scalpel 16.5 Fr ceramic, semi-circular	Semi-circular	8670.961
 Sheath with central bore hole (for 4 Fr ureteral catheter)	Scalpel 16.5 Fr ceramic, semi-circular	Semi-circular	8670.966
 Sheath with central bore hole (for 4 Fr ureteral catheter)	Scalpel 16.5 Fr ceramic, lancet-shaped	Lancet-shaped	8670.981

Recommended accessories		Product no.
Protective sterilization sleeve Receptacle for max. 5 electrodes, reusable	 AUTOCLAVE 134° C / 273° F	33030

URETHROTOME FOR BLIND SLITTING

URETHROTOME

1.3

12 o'clock cutting position







Straight tip



Curved tip



Ball-shaped tip

	Fr	WL	Product no.
Urethrotome 15–45 Fr WL 236 mm Otis, with 3 exchangeable tips (straight, curved, and ball-shaped)	15–45	236 mm	8517.00
Knife for urethrotome			8517.90

IX23 || Subject to modifications. Please note that some products may not be available in all countries. Please always take note of the information that is provided with the product. For more detailed information, please consult with your contact partner or directly with Richard Wolf GmbH.

CYSTO-URETHROSCOPE 8650

E-line

SHEATH SYSTEMS FOR TELESCOPE 4 MM, 0°, 12°, 30°, 70°, AND ADAPTERS

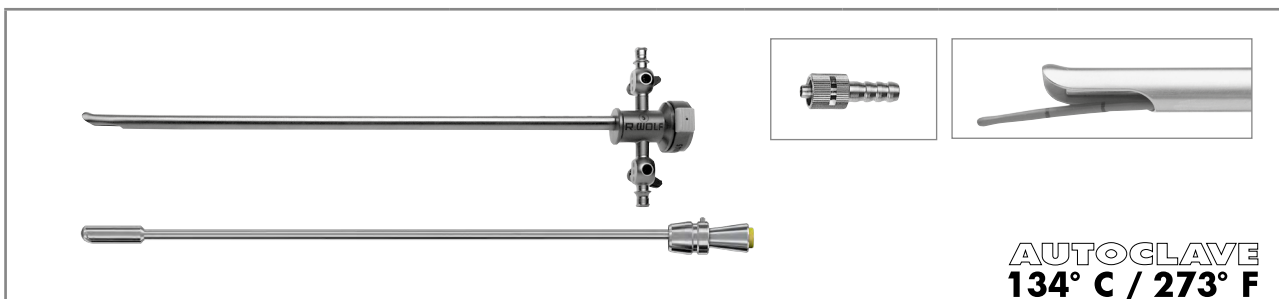

Sheath for cystoscope bndl	Fr	Color coding	SL	Capacity in Fr	Product no.
Sheath for cystoscope 16 Fr comprising: Sheath for cystoscope 16 Fr (8650.0145), obturator for cystoscope 16 Fr (8650.0147), and tube with LUER-LOCK connector (886.00)	16 Fr	Yellow	231 mm	1 x 5*	8650.0141
Sheath for cystoscope 17.5 Fr comprising: Sheath for cystoscope 17.5 Fr (8650.0245), obturator for cystoscope 17.5 Fr (8650.0247), and tube with LUER-LOCK connector (886.00)	17.5 Fr	Green		1 x 5 or 2 x 4	8650.0241
Sheath for cystoscope 19.5 Fr comprising: Sheath for cystoscope 19.5 Fr (8650.0345), obturator for cystoscope 19.5 Fr (8650.0347), and tube with LUER-LOCK connector (886.00)	19.5 Fr	Red		1 x 7 or 2 x 5	8650.0341
Sheath for cystoscope 21 Fr comprising: Sheath for cystoscope 21 Fr (8650.0445), obturator for cystoscope 21 Fr (8650.0447), and tube with LUER-LOCK connector (886.00)	21 Fr	Blue		1 x 10 or 2 x 6	8650.0441
Sheath for cystoscope 23 Fr comprising: Sheath for cystoscope 23 Fr (8650.0545), obturator for cystoscope 23 Fr (8650.0547), and tube with LUER-LOCK connector (886.00)	23 Fr	White		1 x 12 or 2 x 7	8650.0541
Sheath for cystoscope 25 Fr comprising: Sheath for cystoscope 25 Fr (8650.0645), obturator for cystoscope 25 Fr (8650.0647), and tube with LUER-LOCK connector (886.00)	25 Fr	Black		1 x 5	8650.0641

* Urethrosopic only (cystoscopic only suitable for diagnostics via adapter 8650.254)

Also:

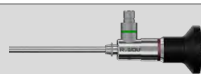

PANOVIEW	Direction of view	Ø	WL	TL	Product no.
Telescope 0° Ø 4 mm WL 298 mm	0°	4 mm	298 mm	365 mm	8650.414
Telescope 12° Ø 4 mm WL 297 mm	12°		297 mm	363 mm	8654.431
Telescope 30° Ø 4 mm WL 300 mm	30°		300 mm	364 mm	8654.422
Telescope 70° Ø 4 mm WL 302 mm	70°		302 mm	364 mm	8650.415
Telescope blue 0° Ø 4 mm WL 298 mm	0°	4 mm	298 mm	365 mm	8650.514
Telescope blue 12° Ø 4 mm WL 298 mm	12°		298 mm	363 mm	8654.531
Telescope blue 30° Ø 4 mm WL 299 mm	30°		299 mm	364 mm	8654.522
Telescope blue 70° Ø 4 mm WL 303 mm	70°		303 mm	362 mm	8650.515

for individual adapters/sheaths and obturators, see URO26 / for accessories, see URO29–URO30

CYSTO-URETHROSCOPE 8650

E-line

SHEATH SYSTEMS FOR TELESCOPE 4 MM, 0°, 12°, 30°, 70°, AND ADAPTERS

CYSTO-URETHROSCOPE 8650

1.4

Individual sheaths and obturators					Adapters for cystoscope		
							
					Only for diagnostics	1 instrument port	2 instrument ports
Individual sheath and obturator	Fr	SL/WL	Color coding	Product no.	Adapter for cystoscope TL 60 mm	Adapter for cystoscope TL 60 mm	Adapter for cystoscope TL 60 mm
Sheath for cystoscope 16 Fr	16 Fr	SL 231 mm	Yellow	8650.0145	8650.254	8650.264	8650.284
Obturator for cystoscope 16 Fr		WL 249 mm		8650.0147			
Sheath for cystoscope 17.5 Fr	17.5 Fr	SL 231 mm	Green	8650.0245			
Obturator for cystoscope 17.5 Fr		WL 249 mm		8650.0247			
Sheath for cystoscope 19.5 Fr	19.5 Fr	SL 231 mm	Red	8650.0345			
Obturator for cystoscope 19.5 Fr		WL 251 mm		8650.0347			
Sheath for cystoscope 21 Fr	21 Fr	SL 231 mm	Blue	8650.0445			
Obturator for cystoscope 21 Fr		WL 249 mm		8650.0447			
Sheath for cystoscope 23 Fr	23 Fr	SL 231 mm	White	8650.0545			
Obturator for cystoscope 23 Fr		WL 249 mm		8650.0547			
Sheath for cystoscope 25 Fr	25 Fr	SL 231 mm	Black	8650.0645			
Obturator for cystoscope 25 Fr		WL 249 mm		8650.0647			
Recommended accessories					Product no.		
Perforated basket for standard telescope 2				Internal dimensions (W x H x D): 454 x 52 x 40 mm External dimensions (W x H x D): 481 x 54 x 59 mm	38016		
Fiber light cable bndl consisting of: Fiber light cable (80662523), projector-side adapter (8095.07), and endoscope-side adapter (809509)				Ø 2.5 mm, 2.3 m long	806625231		

IX23 | Subject to modifications. Please note that some products may not be available in all countries. Please always take note of the information that is provided with the product. For more detailed information, please consult with your contact partner or directly with Richard Wolf GmbH.

CYSTO-URETHROSCOPE 8650

E-line

SHEATH SYSTEMS FOR TELESCOPE 4 MM, 30°, 70°, AND INSERTS WITH ALBARRÁN LEVER

CYSTO-URETHROSCOPE 8650

1.4

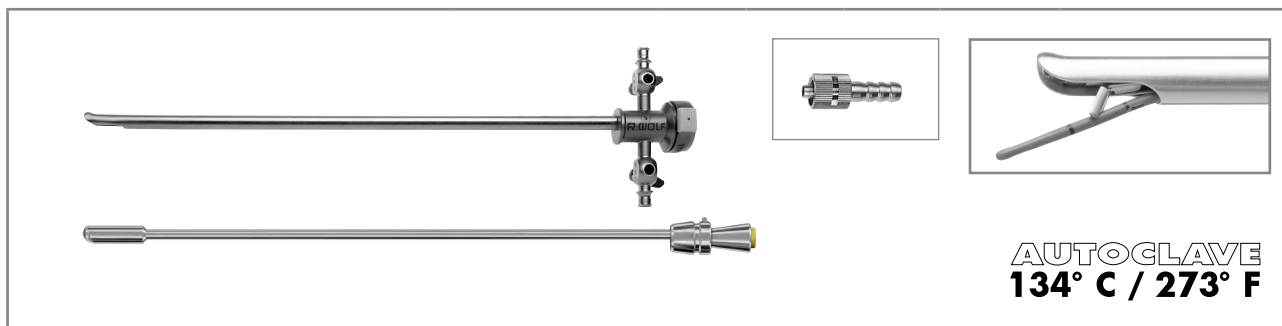

Sheath for cystoscope bndl	Fr	Color coding	SL	Capacity in Fr	Product no.
Sheath for cystoscope 17.5 Fr comprising: Sheath for cystoscope 17.5 Fr (8650.0245), obturator for cystoscope 17.5 Fr (8650.0247), and tube with LUER-LOCK connector (886.00)	17.5 Fr	Green	231 mm	1 x 5 or 2 x 4	8650.0241
Sheath for cystoscope 19.5 Fr comprising: Sheath for cystoscope 19.5 Fr (8650.0345), obturator for cystoscope 19.5 Fr (8650.0347), and tube with LUER-LOCK connector (886.00)	19.5 Fr	Red		1 x 7 or 2 x 5	8650.0341
Sheath for cystoscope 21 Fr comprising: Sheath for cystoscope 21 Fr (8650.0445), obturator for cystoscope 21 Fr (8650.0447), and tube with LUER-LOCK connector (886.00)	21 Fr	Blue		1 x 10 or 2 x 6	8650.0441
Sheath for cystoscope 23 Fr comprising: Sheath for cystoscope 23 Fr (8650.0545), obturator for cystoscope 23 Fr (8650.0547), and tube with LUER-LOCK connector (886.00)	23 Fr	White		1 x 12 or 2 x 7	8650.0541

Also:



PANOVIEW	Direction of view	Ø	WL	TL	Product no.
Telescope 30° Ø 4 mm WL 300 mm	30°	4 mm	300 mm	364 mm	8654.422
Telescope 70° Ø 4 mm WL 302 mm	70°		302 mm	364 mm	8650.415
Telescope blue 30° Ø 4 mm WL 299 mm	30°	4 mm	299 mm	364 mm	8654.522
Telescope blue 70° Ø 4 mm WL 303 mm	70°		303 mm	362 mm	8650.515

for individual adapters/sheaths and obturators, see URO28

Recommended accessories	Product no.
Perforated basket for standard telescope 2	Internal dimensions (W x H x D): 454 x 52 x 40 mm External dimensions (W x H x D): 481 x 54 x 59 mm 38016
Fiber light cable bndl consisting of: Fiber light cable (80662523), projector-side adapter (8095.07), and endoscope-side adapter (809509)	Ø 2.5 mm, 2.3 m long 806625231



CYSTO-URETHROSCOPE 8650

E-line

SHEATH SYSTEMS FOR TELESCOPE 4 MM, 30°, 70°, AND INSERTS WITH ALBARRÁN LEVER

CYSTO-URETHROSCOPE 8650

1.4







Individual sheaths and obturators						
					 <p>1 instrument port</p>	 <p>2 instrument ports</p>
Individual sheath and obturator	Fr	SL/WL	Color coding	Product no.	Working insert for cystoscope 30/70	Working insert for cystoscope 0/30/70
Sheath for cystoscope 17.5 Fr	17.5 Fr	SL 231 mm	Green	8650.0245	8650.214	8650.204
Obturator for cystoscope 17.5 Fr		WL 249 mm		8650.0247		
Sheath for cystoscope 19.5 Fr	19.5 Fr	SL 231 mm	Red	8650.0345		
Obturator for cystoscope 19.5 Fr		WL 251 mm		8650.0347		
Sheath for cystoscope 21 Fr	21 Fr	SL 231 mm	Blue	8650.0445		
Obturator for cystoscope 21 Fr		WL 249 mm		8650.0447		
Sheath for cystoscope 23 Fr	23 Fr	SL 231 mm	White	8650.0545		
Obturator for cystoscope 23 Fr		WL 249 mm		8650.0547		

IX23 || Subject to modifications. Please note that some products may not be available in all countries. Please always take note of the information that is provided with the product. For more detailed information, please consult with your contact partner or directly with Richard Wolf GmbH.

OPTICAL FORCEPS AND SCISSORS

FOR CYSTO-URETHROSCOPE 8650
WITH TELESCOPE 4 MM, 0°



			Suitable for sheaths from	Product no.
	Opt. biopsy forceps, spoon-shaped		19.5 Fr	8650.604
	Opt. grasping forceps, straight		19.5 Fr	8650.684
	Opt. biopsy forceps, "Marburg" model	Short distance between jaw section and telescope means biopsies can be taken from the area around the bladder neck	19.5 Fr	8650.614
	Opt. biopsy forceps, spoon curved downward	for taking biopsies from the transition area between the bladder neck and roof, and from the area at the back of the urethra	19.5 Fr	8650.774
	Opt. scissors, "Wuppertal" model, curved downward	for opening uretero cells, cutting through migrated sutures, and removing polyps from the base, and for ostium slitting	19.5 Fr	8650.644
	Opt. grasping forceps curved downward	for crushing small, soft stones	19.5 Fr	8650.654
	Opt. stone grasping forceps curved downward	for small stones, for processing stone fragments	23 Fr	8650.664





for cysto-urethroscope 8650 with telescope 4 mm, 0°			Suitable for sheaths from	Product no.
	Opt. coag. biopsy forceps Tauber	for combined biopsy and hemostasis. Particularly suitable for bladder mapping and quadrant biopsies. Immediate hemostasis without changing instruments or performing a time-consuming reorientation.	21 Fr	8650.624

IX23 || Subject to modifications. Please note that some products may not be available in all countries. Please always take note of the information that is provided with the product. For more detailed information, please consult with your contact partner or directly with Richard Wolf GmbH.

VIEWING OBTURATORS

FOR INSERTING THE SHEATH WHILE VIEWING FOR 4 MM TELESCOPES FROM 0° TO 30°

				
for inserting the sheath while viewing for 4 mm telescopes from 0° to 30°		WL	Suitable for Sheath	Product no.
 distal end rounded	Viewing obturator for cystoscope 17.5 Fr	249 mm	17.5 Fr	8650.714
	Viewing obturator for cystoscope 19.5 Fr		19.5 Fr	8650.724
	Viewing obturator for cystoscope 21 Fr		21 Fr	8650.734
	Viewing obturator for cystoscope 23 Fr		23 Fr	8650.744

Recommended accessories	Product no.
HF connection cable	see UR0103/104

MIDI-SIZE

CYSTO-URETHROSCOPE

"MIDI-SIZE" CYSTO-URETHROSCOPE

1.5

for smaller anatomies



AUTOCLAVE
134° C / 273° F

Sheath for cystoscope bndl	consisting of:	Fr	Capacity in Fr	Color coding	Product no.
Sheath for cystoscope 12.5 Fr with 2 irrigation valves	Sheath for cystoscope 12.5 Fr (86720255), obturator for cystoscope 12.5 Fr (86720257), and tube with LUER-LOCK connector (886.00)	12.5	5	Green	86720251
Sheath for cystoscope 14.5 Fr with 2 irrigation valves	Sheath for cystoscope 14.5 Fr (86720455), obturator for cystoscope 14.5 Fr (86720457), and tube with LUER-LOCK connector (886.00)	14.5	7	Green	86720451

Also: individual sheaths and obturators



Individual sheath and obturator	SL/WL	Color coding	Product no.	Adapter for cystoscope TL 65 mm
Sheath for cystoscope 12.5 Fr	SL 193 mm	Green	86720255	8672265
Obturator for cystoscope 12.5 Fr	WL 211 mm	Green	86720257	
Sheath for cystoscope 14.5 Fr	SL 194 mm	White	86720455	
Obturator for cystoscope 14.5 Fr	WL 211 mm	White	86720457	

Also:



	Ø	WL	TL	Product no.
Telescope 30° Ø 2.7 mm WL 267 mm	2.7 mm	267 mm	331 mm	8672432



Recommended accessories

Product no.

Perforated basket for standard telescope 2	Internal dimensions (W x H x D): 454 x 52 x 40 mm External dimensions (W x H x D): 481 x 54 x 59 mm	38016
Fiber light cable bndl consisting of: Fiber light cable (80662523), projector-side adapter (8095.07), and endoscope-side adapter (809509)	Ø 2.5 mm, 2.3 m long	806625231
HF connection cable		see UR0103/104

MIDI-SIZE

FLEXIBLE AUXILIARY INSTRUMENTS

		WL	TL	Fr	Product no.
	Flex. biopsy forceps 5 Fr WL 315 mm	315 mm	465 mm	5	829.05
	Flex. biopsy forceps 7 Fr WL 375 mm	375 mm	490 mm	7	829.07
	Flex. grasping forceps 5 Fr WL 315 mm	315 mm	465 mm	5	828.05
	Flex. grasping forceps 7 Fr WL 365 mm	365 mm	515 mm	7	828.07
	Flex. scissors 7 Fr WL 375 mm	375 mm	490	7	830.07

ATRAUMATIC COMPACT CYSTO-URETHROSCOPE

14/17 Fr, 25° AND ADAPTERS



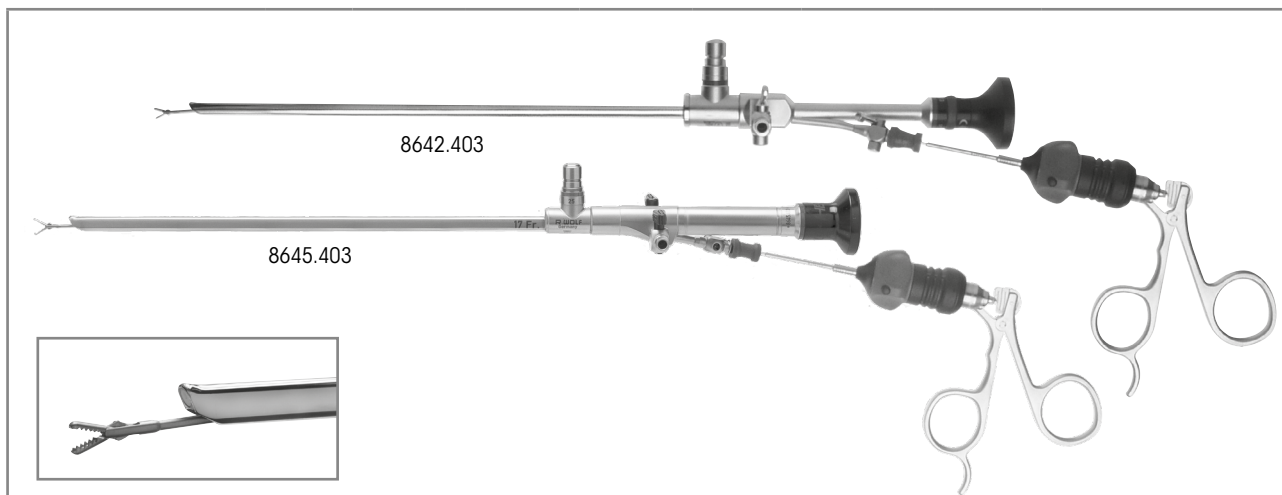

ATRAUMATIC COMPACT CYSTO-URETHROSCOPE

1.6



	Direction of view	WL	TL	Sheath	Working channel		Product no.
					for auxiliary instruments	Shape	
Cystoscope 25° 14 Fr WL 218 mm with straight eyepiece, atraumatically shaped tip	25°	218 mm	358 mm	14 Fr	Up to 5 Fr	Oval	8642.403
Cystoscope 25° 17 Fr WL 224 mm with straight eyepiece, atraumatically shaped tip	25°	224 mm	364 mm	17 Fr	Up to 7 Fr	Oval	8645.403

Also:

		WL	TL	Fr	Product no.
	Flex. biopsy forceps 7 Fr WL 375 mm	375 mm	490 mm	7	829.07
	Flex. biopsy forceps 5 Fr WL 315 mm	315 mm	465 mm	5	829.05
	Flex. grasping forceps 7 Fr WL 365 mm	365 mm	515 mm	7	828.07
	Flex. grasping forceps 5 Fr WL 315 mm	315 mm	465 mm	5	828.05
	Flex. scissors 7 Fr WL 375 mm	375 mm	490 mm	7	830.07
	Coag. electrode mono 6 Fr WL 400 mm	400 mm	-	6	823.06
	Coag. electrode mono 5 Fr WL 400 mm	400 mm	-	5	823.05

Recommended accessories

Product no.

Perforated basket for cysto-urethroscope	Internal dimensions (W x H x D): 435 x 54 x 73 mm External dimensions (W x H x D): 451 x 64 x 80 mm	38013
Fiber light cable bndl consisting of: Fiber light cable (80662523), projector-side adapter (8095.07), and endoscope-side adapter (809509)	Ø 2.5 mm, 2.3 m long	806625231







FORCEPS AND SCISSORS

SMALL MODULAR SYSTEM **HySafe**

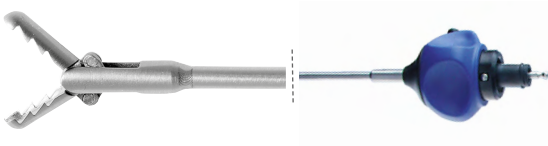
FOR ATRAUMATIC COMPACT CYSTO-URETHROSCOPES 14/17 Fr, 25°

ATRAUMATIC COMPACT CYSTO-URETHROSCOPE

1.6

Grasping forceps jaw insert with sheath				Handle with overload protection	Complete instrument • Jaw section • Handle	
	Product no.	Fr	WL	8083.001	Product no.	
	Grasping forceps bndl Distal angled with pike-mouth jaws	8642.6508	5	340 mm	•	8642.6502
		8645.6508	7	325 mm	•	8645.6502
	Grasping forceps bndl - Spoon	8642.6008	5	340 mm	•	8642.6002
		8645.6008	7	340 mm	•	8645.6002
	Biopsy forceps bndl	8642.6318	5	340 mm	•	8642.6312
	Scissors bndl	8642.6818	5	340 mm	•	8642.6812
	Grasping forceps bndl	8968.6808	6	425 mm	•	8968.6802

IX23 || Subject to modifications. Please note that some products may not be available in all countries. Please always take note of the information that is provided with the product. For more detailed information, please consult with your contact partner or directly with Richard Wolf GmbH.

FLEXIBLE FIBER CYSTOSCOPES 5 MM/15 Fr

CHANNEL 2.5 MM/7.5 Fr

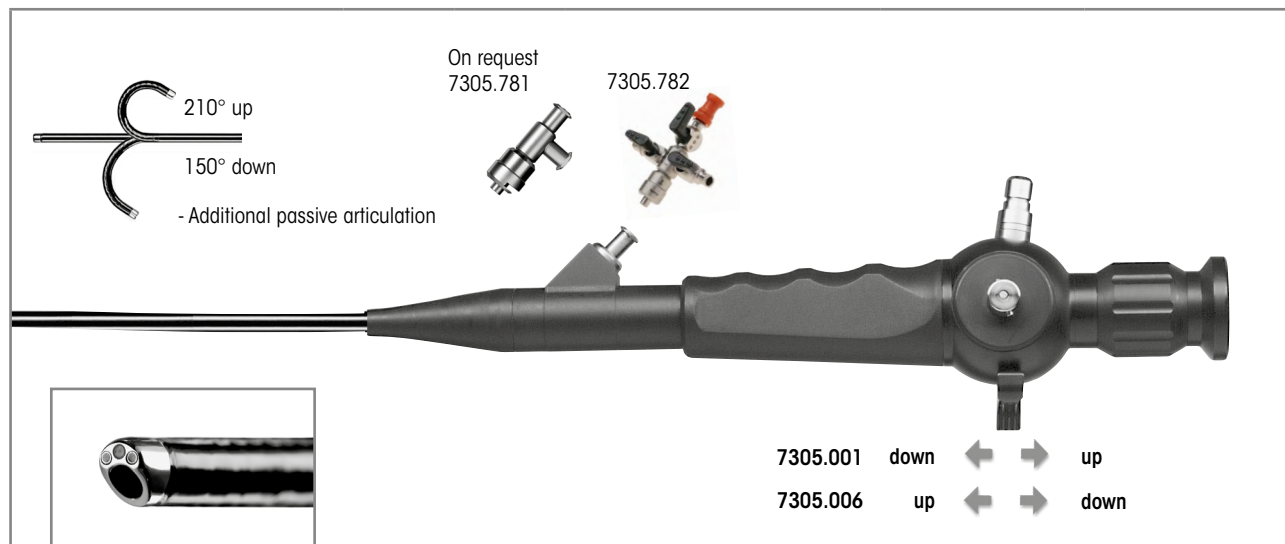

	Outer Ø	Working channel	WL	Control lever in distal direction – articulation downward	Control lever in distal direction – articulation upward	Product no.
Fiber cystoscope 15 Fr WL 400 mm Slanted distal tip Articulation +210°/-150° Direction of view 0°, angle of view 110°	15 Fr	7.5 Fr	400 mm	•		7305.001
					•	7305.006
Fiber cystoscope bndl consisting of: Fiber cystoscope 15 Fr WL 400 mm (7305.001) Adapter with 2 irrigation valves and 1 instrument port (7305.782) Leakage tester for flex. endoscopes (163.903) Pressure equalization valve (163.904) Cleaning brush Ø 3 mm, TL 1,200 mm (Pack = 10 PCS) (7990002)				•		730500111
Fiber cystoscope bndl consisting of: Fiber cystoscope 15 Fr WL 400 mm (7305.006) Adapter with 2 irrigation valves and 1 instrument port (7305.782) Leakage tester for flex. endoscopes (163.903) Pressure equalization valve (163.904) Cleaning brush Ø 3 mm, TL 1,200 mm (Pack = 10 PCS) (7990002)					•	730500611









Recommended accessories		Product no.
Fiber light cable bndl consisting of: Fiber light cable Ø 2.5 mm, TL 2.3 m (80662523), projector-side adapter (8095.07), and endoscope-side adapter (809509)	Ø 2.5 mm, 2.3 m long	806625231
Perforated basket for flexible endoscopes Also: fixing ring Ø 50.39 mm	(W x H x D): 448 x 106 x 288 mm	33016 643301261

IX23 || Subject to modifications. Please note that some products may not be available in all countries. Please always take note of the information that is provided with the product. For more detailed information, please consult with your contact partner or directly with Richard Wolf GmbH.

FLEXIBLE FIBER CYSTOSCOPES 5 MM/15 Fr

TECHNICAL DATA/AUXILIARY INSTRUMENTS

Fiber cystoscope 15 Fr WL 400 mm	7305.001/7305.006
Distal tip	Slanted distal tip
Sheath diameter	15 Fr
Number of working channels	1
Working/irrigation channel diameter	7.5 Fr
Articulation	210° upward, 150° downward
Working length	400 mm
Angle of view	110°
Direction of view	0°

Auxiliary instruments	Outer Ø	WL	TL	Product no.
 Flex. biopsy forceps 5 Fr WL 550 mm	1.6 mm 5 Fr	550 mm	700 mm	829.051
 Flex. grasping forceps 5 Fr WL 550 mm	1.6 mm 5 Fr	550 mm	680 mm	8735.685
 Flex. grasping forceps 6.6 Fr WL 550 mm	2.0 mm 6.6 Fr	550 mm	690 mm	8736.685
 Adapter with 2 Luer connections, male, quick-release mechanism			36 mm	7305.781
 Adapter with 2 irrigation valves and 1 instrument port, quick-release mechanism			57 mm	7305.782
 Also: Luer sealing cap				15023205
 RIWO rubber cap, capacity 0.8 mm				88.01
 Universal sealing valve 1–6 Fr for inserting auxiliary instruments of 1–6 Fr				4712348

vision EF

FLEXIBLE 1-CHANNEL SENSOR CYSTOSCOPES



	Outer Ø	Working channel	WL	Control lever in distal direction – articulation downward	Control lever in distal direction – articulation upward	Product no.
Sensor cystoscope 16.2 Fr WL 400 mm Slanted distal tip Articulation +210°/-210° Direction of view 0°, angle of view 110°	16.2 Fr	7.5 Fr	400 mm	•		73151001
					•	73151006
Sensor cystoscope bndl consisting of: Sensor cystoscope 16.2 Fr, WL 400 mm (73151001), leakage tester for flex. endoscopes (163.903), pressure equalization valve (163.904), Luer sealing cap (15023205), and cleaning brush Ø 5 mm, TL 1,200 mm (Pack = 10 PCS) (7990005)				•		731510012
Fiber cystoscope bndl consisting of: Sensor cystoscope 16.2 Fr, WL 400 mm (73151006), leakage tester for flex. endoscopes (163.903), pressure equalization valve (163.904), Luer sealing cap (15023205), and cleaning brush Ø 5 mm, TL 1,200 mm (Pack = 10 PCS) (7990005)					•	731510062

Recommended accessories		Product no.
Fiber light cable bndl consisting of: Fiber light cable Ø 2.5 mm, TL 2.3 m (80662523), projector-side adapter (8095.07), and endoscope-side adapter (809509)	Ø 2.5 mm, 2.3 m long	806625231
Perforated basket for flexible endoscopes Also: fixing ring Ø 50.39 mm 	(W x H x D): 448 x 106 x 288 mm	33016
		643301261
Flexible auxiliary instruments		see UR039







vision EF FLEXIBLE SENSOR CYSTOSCOPES

TECHNICAL DATA

Sensor cystoscope 16.2 Fr WL 400 mm	73151001/73151006
Distal tip	Cylindrical, atraumatic, slanted plastic tip 11.5 Fr
Sheath diameter	16.2 Fr
Number of working channels	1
Working/irrigation channel diameter	7.5 Fr
Articulation	210° upward, 210° downward
Working length	400 mm
Angle of view	110°
Illumination	Two distally integrated LEDs
Handle	Ergonomic handle design with axial cable outlet
Positioning of the working and irrigation channel in relation to the picture	At 3 o'clock
Endopicture	Octagonal, detail enhancement, automatic white balance, and brightness control, no focusing necessary
Cable length	2.5 m

vision EF FLEXIBLE SENSOR CYSTOSCOPES

AUXILIARY INSTRUMENTS

		Outer Ø	WL	TL	Product no.
	Flex. biopsy forceps 5 Fr WL 550 mm	1.6 mm 5 Fr	550 mm	700 mm	829.051
	Flex. grasping forceps 5 Fr WL 550 mm	1.6 mm 5 Fr	550 mm	680 mm	8735.685
	Adapter with 2 irrigation valves and 1 instrument port, quick-release mechanism			57 mm	7305.782
	Also: Luer sealing cap				15023205
	RIWO rubber cap, capacity 0.8 mm				88.01
	Universal sealing valve 1–6 Fr for inserting auxiliary instruments of 1–6 Fr				4712348
	Adapter for machine leakage tests				163.905

mamba
VISION
FLEXIBLE SENSOR CYSTOSCOPES
FOR ENDOCAM **Logic 4K** CONTROLLER

"MAMBA" FLEXIBLE SENSOR CYSTOSCOPES

1.9



	Outer Ø	Working channel	WL	Control lever in distal direction – articulation downward	Control lever in distal direction – articulation upward	Product no.
Sensor cystoscope 16.2 Fr WL 400 mm Slanted distal tip Articulation +210°/-210° Direction of view 0°, angle of view 110°	16.2 Fr	7.5 Fr	400 mm	•		7315001
				•	7315006	
Sensor cystoscope bndl consisting of: Sensor cystoscope 16.2 Fr, WL 400 mm (7315001), leakage tester for flex. endoscopes (163.903), pressure equalization valve (163.904), Luer sealing cap (15023205), and cleaning brush Ø 5 mm, TL 1,200 mm (Pack = 10 PCS) (7990005)				•		73150012
Sensor cystoscope bndl consisting of: Sensor cystoscope 16.2 Fr, WL 400 mm (7315006), leakage tester for flex. endoscopes (163.903), pressure equalization valve (163.904), Luer sealing cap (15023205), and cleaning brush Ø 5 mm, TL 1,200 mm (Pack = 10 PCS) (7990005)					•	73150062
Recommended accessories						Product no.
Fiber light cable bndl consisting of: Fiber light cable Ø 2.5 mm, TL 2.3 m (80662523), projector-side adapter (8095.07), and endoscope-side adapter (809509)				Ø 2.5 mm, 2.3 m long		806625231
Perforated basket for flexible endoscopes Also: fixing ring Ø 50.39 mm				(W x H x D): 448 x 106 x 288 mm		33016 643301261
Flexible auxiliary instruments						see URO42

IX23 || Subject to modifications. Please note that some products may not be available in all countries. Please always take note of the information that is provided with the product. For more detailed information, please consult with your contact partner or directly with Richard Wolf GmbH.

Sensor cystoscope 16.2 Fr WL 400 mm	7315001/7315006
Distal tip	11.5 Fr, atraumatic tip made of plastic, two distally integrated LEDs
Sheath diameter	16.2 Fr
Number of working channels	1
Working/irrigation channel diameter	7.5 Fr
Articulation	210° upward, 210° downward
Working length	400 mm
Angle of view	110°
Handle	Ergonomic handle design with axial cable outlet
Positioning of the working and irrigation channel in relation to the picture	At 3 o'clock
Endopicture	Octagonal, 3 levels of detail magnification, and 6x digital zoom; automatic white balance, light control, and focus
Compatible camera control unit	ENDOCAM Logic 4K ENDOCAM Logic HD







Required video equipment

Product no.



ENDOCAM Logic 4K camera control unit bndl
 consisting of:
 ENDOCAM Logic 4K camera control unit (5525301)
 Handheld remote control (5525401)
 1x USB flash memory 32 GB (72321829)
 1x HDMI/HDMI cable, lockable, 3.0 m (103847)
 1x power cable (2440.03)

55253011

		Outer Ø	WL	TL	Product no.
	Flex. biopsy forceps 5 Fr WL 550 mm	1.6 mm 5 Fr	550 mm	700 mm	829.051
	Flex. grasping forceps 5 Fr WL 550 mm	1.6 mm 5 Fr	550 mm	700 mm	828.051
	Adapter with 2 irrigation valves and 1 instrument port, quick-release mechanism			57 mm	7305.782
	Also: Luer sealing cap				15023205
	RIWO rubber cap, capacity 0.8 mm				88.01
	for inserting auxiliary instruments of 1–6 Fr Universal sealing valve 1–6 Fr				4712348
	Adapter for machine leakage tests				163.905

System blue

SYSTEM COMPONENTS

FOR PHOTODYNAMIC DIAGNOSTICS (PDD)

IX23 || Subject to modifications. Please note that some products may not be available in all countries. Please always take note of the information that is provided with the product. For more detailed information, please consult with your contact partner or directly with Richard Wolf GmbH.

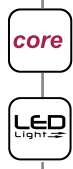

				Product no.
ENDOLIGHT LED blue bndl consisting of: ENDOLIGHT LED blue (5165001), patch cable, RJ45 SFTP, 0.5 m (72325378), toggle footswitch (2030.105), and power cable 3 m long (2440.03)				51650011
ENDOCAM Logic 4K camera control unit bndl consisting of: ENDOCAM Logic 4K camera control unit (5525301), handheld remote control (5525401), USB flash memory 32 GB (72321829), HDMI/HDMI cable, lockable, 3.0 m (103847), and power cable (2440.03)				55253011
ENDOCAM Logic HD Pendual camera head blue Cable length 3 m				5525833
Also:				
PANOVIEW	Ø	WL	TL	Product no.
Telescope blue 0° Ø 4 mm WL 298 mm	4.0 mm	298 mm	365 mm	8650.514
Telescope blue 12° Ø 4 mm WL 298 mm		298 mm	363 mm	8654.531
Telescope blue 30° Ø 4 mm WL 299 mm		299 mm	364 mm	8654.522
Telescope blue 70° Ø 4 mm WL 303 mm		303 mm	362 mm	8650.515
Special fiber light cable 3.5 mm, 2.3 m set consisting of: Fiber light cable blue Ø 3.5 mm (80673523), endoscope-side adapter (809509)	3.5 mm		2.3 m	806735231

"SYSTEM BLUE" FOR PHOTODYNAMIC DIAGNOSTICS (PDD)

1.10

System blue

SYSTEM COMPONENTS FOR PHOTODYNAMIC DIAGNOSTICS (PDD)

CYSTOSCOPY

"SYSTEM BLUE" FOR PHOTODYNAMIC DIAGNOSTICS (PDD)

1.10

Cystoscopy		Product no.
Recommendation: PDD cysto-urethroscope with adapter		
	PANOVIEW telescope blue 70° Ø 4 mm WL 303 mm	8650.515
	Adapter for cystoscope	8650.284
	Sheath for cystoscope 19.5 Fr	8650.0341
	Obturator for cystoscope 19.5 Fr	8650.0347

IX23 || Subject to modifications. Please note that some products may not be available in all countries. Please always take note of the information that is provided with the product. For more detailed information, please consult with your contact partner or directly with Richard Wolf GmbH.

FOR RESECTOSCOPES

TELESCOPE 4 MM, 0°, 12°, 30°

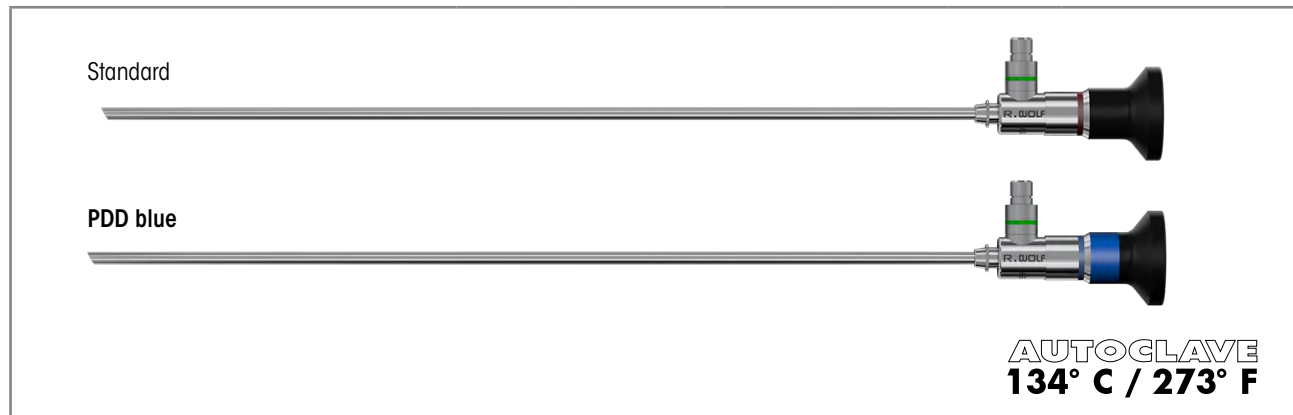

	Direction of view	Color coding	Ø	WL	TL	Product no.
Telescope 0° Ø 4 mm WL 298 mm	0°	Blue	4.0 mm	298 mm	365 mm	8650.414
Telescope blue 0° Ø 4 mm WL 298 mm				298 mm	365 mm	8650.514**
Telescope 12° Ø 4 mm WL 297 mm	12°	Orange	4.0 mm	297 mm	363 mm	8654.431
Telescope blue 12° Ø 4 mm WL 298 mm				298 mm	363 mm	8654.531**
Telescope 30° Ø 4 mm WL 300 mm	30°	Red	4.0 mm	300 mm	364 mm	8654.422
Telescope blue 30° Ø 4 mm WL 299 mm				299 mm	364 mm	8654.522**
Telescope 30° Ø 3.3 mm WL 299 mm				299 mm	360 mm	8656.422
Telescope 25° Ø 4 mm WL 342 mm	25°		4.0 mm	342 mm	404 mm	8668.433*
Telescope 70° Ø 4 mm WL 302 mm	70°	Yellow	4.0 mm	302 mm	364 mm	8650.415
Telescope blue 70° Ø 4 mm WL 303 mm				303 mm	364 mm	8650.515**

* Only available in 25°.

** We have adapted our PANOVIEW telescopes to our new, high-performance blue PDD system.



The PANOVIEW telescopes are marked "blue" to distinguish them and they can also be used with your existing PDD system, of course.

Recommended accessories		Product no.
Perforated basket for standard telescope 2	Internal dimensions (W x H x D): 454 x 52 x 40 mm External dimensions (W x H x D): 481 x 54 x 59 mm	38016
Fiber light cable bndl consisting of: Fiber light cable (80662523), projector-side adapter (8095.07), and endoscope-side adapter (809509)	Ø 2.5 mm, 2.3 m long	806625231

OVERVIEW



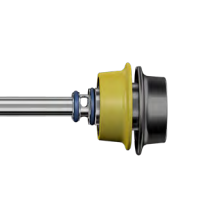

"SHARK" RESECTOSCOPES (MONOPOLAR/BIPOLAR)

Sheaths for continuous irrigation



CI Double sheath system	
	
Outer sheath	Inner sheath
	
8675424	8675322
-	-
8675426	8675324
-	-

Sheath size	
CI	22/24 Fr
II	24 Fr
CI	24/26 Fr
II	26 Fr

Sheaths for intermittent irrigation

II Sheath with rotatable irrigation adapter		
		
Rotatable irrigation adapter with 4 mm Luer connection	Rotatable irrigation adapter with 3 mm Luer connection, with stopcock	Sheath
		
-	-	-
8676354	8676361	8676324
-	-	-
8676354	8676361	8676326
Two-way stopcock 88351	Two-way stopcock 88350	

Monopolar working elements

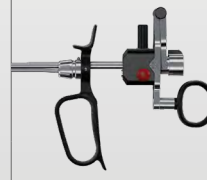
Active		Passive	
Handle closed	Handle closed with comfort thumb rest	Handle open	Handle closed
			
8681205*	-	8681224*	-
8674205	8674234	8674224	8674225
Spare rubber cap, red (Pack = 5 pcs) 8874			
Thumb ring with relatively large inner diameter 15008.159			

Direction of view
0°
12°
30°



CI = continuous irrigation **II** = intermittent irrigation

* Not suitable for 22/24 Fr Double sheath system

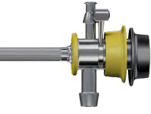

IX23 II Subject to modifications. Please note that some products may not be available in all countries. For more detailed information, please consult with your contact partner or directly with Richard Wolf GmbH.

Obturator

II Sheath with central stopcock	
	
Sheath	Connection part
-	-
8676424	8676342
-	-
8676426	8676343

Obturator	Viewing obturator	Dilatations obturator
		
		
8673022	8673122	-
8673024	8673124	8673224
8673026	8673126	8673226



Telescopes, Ø 4 mm

Standard	PDD
	
8650.414	8650.514
8654.431	8654.531
8654.422	8654.522
Fiber light cable 2.5 mm 3.0 m set 806625301	

OVERVIEW



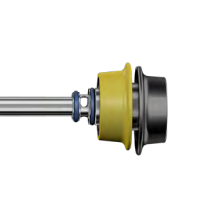

"SHARK" RESECTOSCOPES (MONOPOLAR/BIPOLAR)

Sheaths for continuous irrigation

CI Double sheath system	
	
Outer sheath	Inner sheath
	
8675424	8675322
-	-
8675426	8675324
-	-

Sheath size	
CI	22/24 Fr
II	24 Fr
CI	24/26 Fr
II	26 Fr

Sheaths for intermittent irrigation

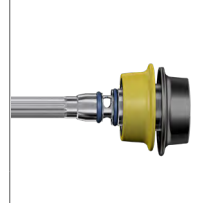
II Sheath with rotatable irrigation adapter		
		
Rotatable irrigation adapter with 4 mm Luer connection	Rotatable irrigation adapter with 3 mm Luer connection, with stopcock	Sheath
		
-	-	-
8676354	8676361	8676324
-	-	-
8676354	8676361	8676326
Two-way stopcock 88351	Two-way stopcock 88350	

Bipolar working elements

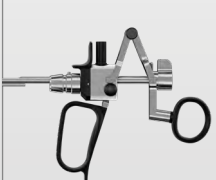
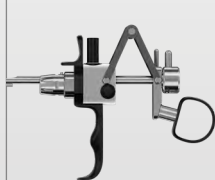
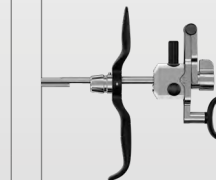
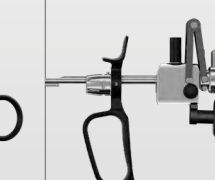
Active		Passive	
Handle closed	Handle open	Handle open	Handle closed
			
8680.205	8680.204	8680.224	8680.225
Spare rubber cap, black (Pack = 5 pcs) 8880			
Thumb ring with relatively large inner diameter 15008.159			

Direction of view
0°
12°
30°

CI = continuous irrigation
 II = intermittent irrigation

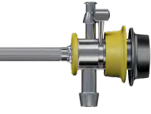

IX23 || Subject to modifications. Please note that some products may not be available in all countries. For more detailed information, please consult with your contact partner or directly with Richard Wolf GmbH.

Obturator

II Sheath with central stopcock	
	
Sheath	Connection part
-	-
8676424	8676342
-	-
8676426	8676343

Obturator	Viewing obturator	Dilatations obturator
		
		
8673022	8673122	-
8673024	8673124	8673224
8673026	8673126	8673226

Telescopes, Ø 4 mm

Standard	PDD
	
8650.414	8650.514
8654.431	8654.531
8654.422	8654.522
Fiber light cable 2.5 mm 3.0 m set 806625301	



MONOPOLAR RESECTOSCOPE

FOR TELESCOPE 4 MM, 0°, 12°, 30°
WITH CONTINUOUS IRRIGATION DOUBLE SHEATH SYSTEM
FOR RESECTION IN SALINE SOLUTION

Working element, inner sheath, and telescope rotate in outer sheath



AUTOCLAVE
134° C / 273° F

CI Double sheath system

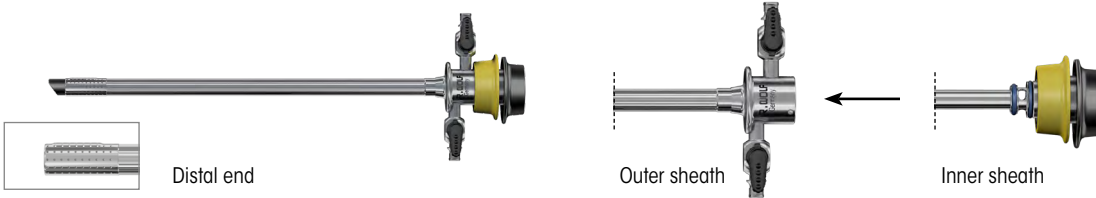

for sheath sizes		SL/WL	Color coding	Product no.
CI 22/24 Fr	Outer sheath for resectoscope 24 Fr	SL 189 mm	Green	8675424
	Inner sheath for resectoscope 22 Fr	SL 205 mm		8675322
Also:				
	Obturator for resectoscope 22 Fr	WL 232 mm	Green	8673022
	Viewing obturator for resectoscope 22 Fr			8673122
CI 24/26 Fr	Outer sheath for resectoscope 26 Fr	SL 189 mm	Yellow	8675426
	Inner sheath for resectoscope 24 Fr	SL 205 mm		8675324
Also:				
	Obturator for resectoscope 24 Fr	WL 233 mm	Yellow	8673024
	Viewing obturator for resectoscope 24 Fr	WL 232 mm		8673124
	Dilatations obturator f. resectoscope 24 Fr	WL 247 mm		8673224

Telescopes		see UR045
Working elements		see UR056
Electrodes		see UR065-68
Monopolar connection cable		see UR0103/104

"SHARK" RESECTOSCOPES (MONOPOLAR/BIPOLAR)

1.11

IX23 || Subject to modifications. Please note that some products may not be available in all countries. Please always take note of the information that is provided with the product. For more detailed information, please consult with your contact partner or directly with Richard Wolf GmbH.



MONOPOLAR RESECTOSCOPE

FOR TELESCOPE 4 MM, 0°, 12°, 30°

WITH INTERMITTENT IRRIGATION AND ROTATABLE IRRIGATION ADAPTER

FOR RESECTION IN SALINE SOLUTION



II Sheath with rotatable irrigation adapter

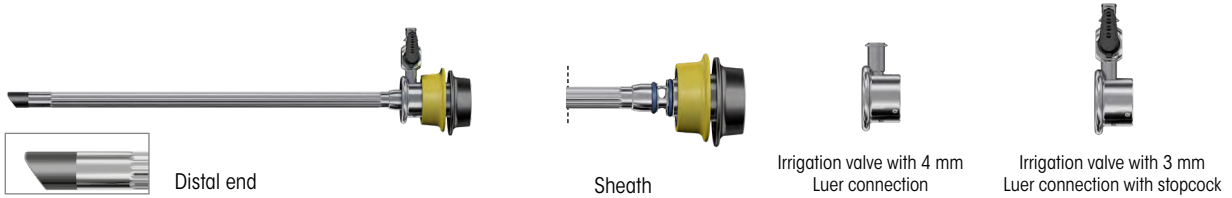

for sheath sizes		SL/WL	Color coding	Product no.
24 Fr	Sheath for resectoscope 24 Fr	SL 200 mm	Yellow	8676324
	Irrigation adapter for resectoscope 24/26 Fr with 4 mm Luer connection			8676354*
	Irrigation adapter for resectoscope 24/26 Fr with 3 mm Luer connection with stopcock			8676361**
Also:				
	Obturator for resectoscope 24 Fr	WL 233 mm	Yellow	8673024
	Viewing obturator for resectoscope 24 Fr	WL 232 mm		8673124
	Dilatations obturator f. resectoscope 24 Fr	WL 247 mm		8673224
26 Fr	Sheath for resectoscope 26 Fr	SL 201 mm	Black	8676326
	Irrigation adapter for resectoscope 24/26 Fr with 4 mm Luer connection			8676354*
	Irrigation adapter for resectoscope 24/26 Fr with 3 mm Luer connection with stopcock			8676361**
Also:				
	Obturator for resectoscope 26 Fr	WL 233 mm	Black	8673026
	Viewing obturator for resectoscope 26 Fr	WL 232 mm		8673126
	Dilatations obturator f. resectoscope 26 Fr	WL 248 mm		8673226
* for connection to rotatable irrigation adapter 8676354: Two-way stopcock, maintenance-free, with LUER-LOCK connection				88351
** for connection to rotatable irrigation adapter 8676361: Two-way stopcock, maintenance-free, with LUER-LOCK connection				88350

Telescopes		see UR045
Working elements		see UR056
Electrodes		see UR065-68
Monopolar connection cable		see UR0103/104

"SHARK" RESECTOSCOPES (MONOPOLAR/BIPOLAR) 1.11

IX23 || Subject to modifications. Please note that some products may not be available in all countries. Please always take note of the information that is provided with the product. For more detailed information, please consult with your contact partner or directly with Richard Wolf GmbH.



MONOPOLAR RESECTOSCOPE

FOR TELESCOPE 4 MM, 0°, 12°, 30°
WITH INTERMITTENT IRRIGATION WITH CENTRAL STOPCOCK
FOR RESECTION IN SALINE SOLUTION



II Sheath with central stopcock

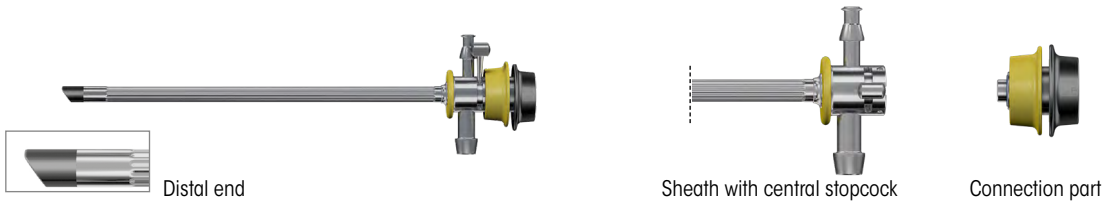

for sheath sizes		SL/WL	Color coding	Product no.
II 24 Fr	Sheath for resectoscope 24 Fr	SL 195 mm	Yellow	8676424
	Connection part for resectoscope 24 Fr	-		8676342
Also:				
	Obturator for resectoscope 24 Fr	WL 233 mm	Yellow	8673024
	Viewing obturator for resectoscope 24 Fr	WL 232 mm		8673124
	Dilatations obturator f. resectoscope 24 Fr	WL 247 mm		8673224
II 26 Fr	Sheath for resectoscope 26 Fr	SL 195 mm	Black	8676426
	Connection part for resectoscope 26 Fr	-		8676343
Also:				
	Obturator for resectoscope 26 Fr	WL 233 mm	Black	8673026
	Viewing obturator for resectoscope 26 Fr	WL 232 mm		8673126
	Dilatations obturator f. resectoscope 26 Fr	WL 248 mm		8673226

Telescopes		see UR045
Working elements		see UR056
Electrodes		see UR065-68
Monopolar connection cable		see UR0103/104

"SHARK" RESECTOSCOPES (MONOPOLAR/BIPOLAR)

1.11

IX23 || Subject to modifications. Please note that some products may not be available in all countries. Please always take note of the information that is provided with the product. For more detailed information, please consult with your contact partner or directly with Richard Wolf GmbH.



BIPOLAR RESECTOSCOPE

FOR TELESCOPE 4 MM, 0°, 12°, 30°
WITH CONTINUOUS IRRIGATION DOUBLE SHEATH SYSTEM
FOR RESECTION IN SALINE SOLUTION

Working element, inner sheath, and telescope rotate in outer sheath



AUTOCLAVE
134° C / 273° F

CI Double sheath system

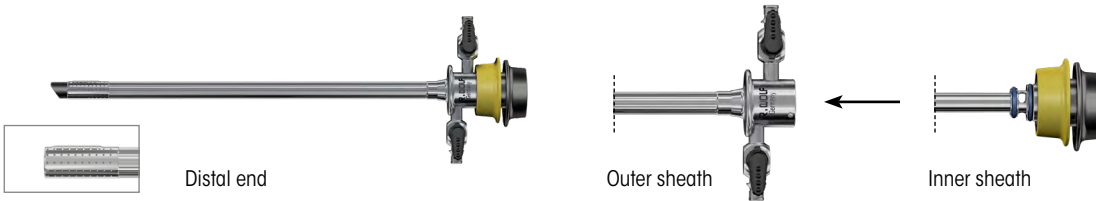

for sheath sizes		SL/WL	Color coding	Product no.
CI 22/24 Fr	Outer sheath for resectoscope 24 Fr	SL 189 mm	Green	8675424
	Inner sheath for resectoscope 22 Fr	SL 205 mm		8675322
Also:				
	Obturator for resectoscope 22 Fr	WL 232 mm	Green	8673022
	Viewing obturator for resectoscope 22 Fr			8673122
CI 24/26 Fr	Outer sheath for resectoscope 26 Fr	SL 189 mm	Yellow	8675426
	Inner sheath for resectoscope 24 Fr	SL 205 mm		8675324
Also:				
	Obturator for resectoscope 24 Fr	WL 233 mm	Yellow	8673024
	Viewing obturator for resectoscope 24 Fr	WL 232 mm		8673124
	Dilatations obturator f. resectoscope 24 Fr	WL 247 mm		8673224

Telescopes		see URO45
Working elements		see URO57
Electrodes		see URO69-71
Bipolar connection cable		see URO105

"SHARK" RESECTOSCOPES (MONOPOLAR/BIPOLAR)

1.11

IX23 || Subject to modifications. Please note that some products may not be available in all countries. Please always take note of the information that is provided with the product. For more detailed information, please consult with your contact partner or directly with Richard Wolf GmbH.



BIPOLAR RESECTOSCOPE

FOR TELESCOPE 4 MM, 0°, 12°, 30°

WITH INTERMITTENT IRRIGATION AND ROTATABLE IRRIGATION ADAPTER

FOR RESECTION IN SALINE SOLUTION



II Sheath with rotatable irrigation adapter

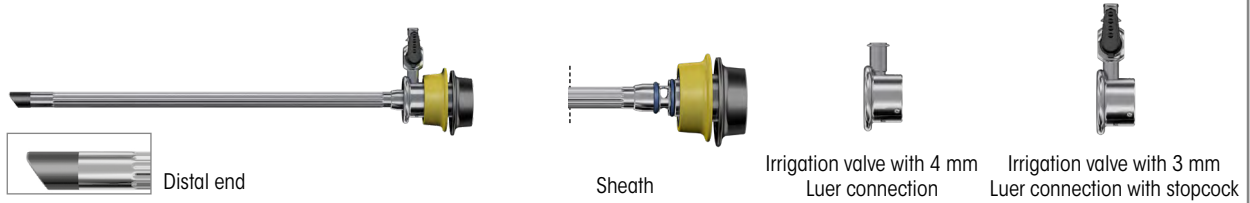

for sheath sizes		SL/WL	Color coding	Product no.
 24 Fr	Sheath for resectoscope 24 Fr	SL 200 mm	Yellow	8676324
	Irrigation adapter for resectoscope 24/26 Fr with 4 mm Luer connection			8676354*
	Irrigation adapter for resectoscope 24/26 Fr with 3 mm Luer connection with stopcock			8676361**
Also:				
	Obturator for resectoscope 24 Fr	WL 233 mm	Yellow	8673024
	Viewing obturator for resectoscope 24 Fr	WL 232 mm		8673124
	Dilatations obturator f. resectoscope 24 Fr	WL 247 mm		8673224
 26 Fr	Sheath for resectoscope 26 Fr	SL 201 mm	Black	8676326
	Irrigation adapter for resectoscope 24/26 Fr with 4 mm Luer connection			8676354*
	Irrigation adapter for resectoscope 24/26 Fr with 3 mm Luer connection with stopcock			8676361**
Also:				
	Obturator for resectoscope 26 Fr	WL 233 mm	Black	8673026
	Viewing obturator for resectoscope 26 Fr	WL 232 mm		8673126
	Dilatations obturator f. resectoscope 26 Fr	WL 248 mm		8673226
* for connection to rotatable irrigation adapter 8676354: Two-way stopcock, maintenance-free, with LUER-LOCK connection				88351
** for connection to rotatable irrigation adapter 8676361: Two-way stopcock, maintenance-free, with LUER-LOCK connection				88350

Telescopes		see URO45
Working elements		see URO57
Electrodes		see URO69-71
Bipolar connection cable		see URO105

IX23 || Subject to modifications. Please note that some products may not be available in all countries. Please always take note of the information that is provided with the product. For more detailed information, please consult with your contact partner or directly with Richard Wolf GmbH.

"SHARK" RESECTOSCOPES (MONOPOLAR/BIPOLAR)

1.11



BIPOLAR RESECTOSCOPE

FOR TELESCOPE 4 MM, 0°, 12°, 30°
WITH INTERMITTENT IRRIGATION WITH CENTRAL STOPCOCK
FOR RESECTION IN SALINE SOLUTION

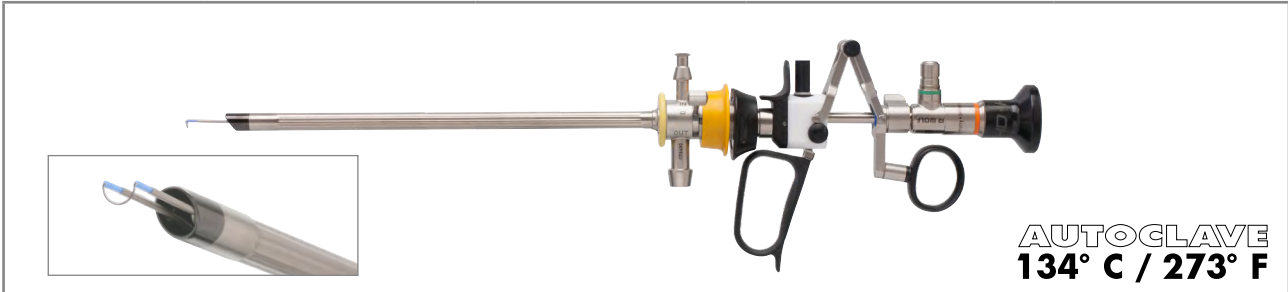

II Sheath with central stopcock

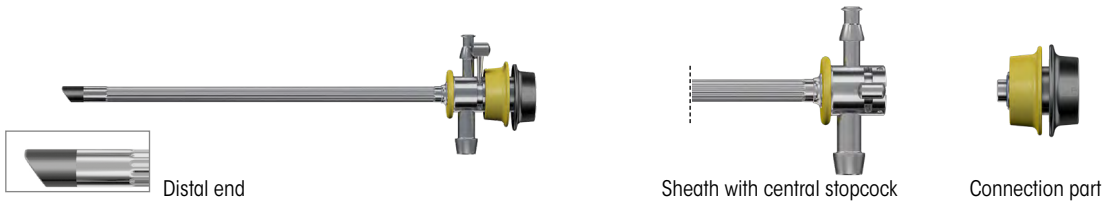

for sheath sizes		SL/WL	Color coding	Product no.
 24 Fr	Sheath for resectoscope 24 Fr	SL 195 mm	Yellow	8676424
	Connection part for resectoscope 24 Fr	-		8676342

Also:

	Obturator for resectoscope 24 Fr	WL 233 mm	Yellow	8673024
	Viewing obturator for resectoscope 24 Fr	WL 232 mm		8673124
	Dilatations obturator f. resectoscope 24 Fr	WL 247 mm		8673224

II
26 Fr

Sheath for resectoscope 26 Fr	SL 195 mm	Black	8676426
Connection part for resectoscope 26 Fr	-		8676343

Also:

	Obturator for resectoscope 26 Fr	WL 233 mm	Black	8673026
	Viewing obturator for resectoscope 26 Fr	WL 232 mm		8673126
	Dilatations obturator f. resectoscope 26 Fr	WL 248 mm		8673226

Telescopes		see URO45
Working elements		see URO57
Electrodes		see URO69-71
Bipolar connection cable		see URO105

"SHARK" RESECTOSCOPES (MONOPOLAR/BIPOLAR)
1.11

IX23 || Subject to modifications. Please note that some products may not be available in all countries. Please always take note of the information that is provided with the product. for more detailed information, please consult with your contact partner or directly with Richard Wolf GmbH.



MONOPOLAR WORKING ELEMENTS

FOR RESECTOSCOPES, MONOPOLAR
TELESCOPE 4 MM, 0°, 12°, 30°

"SHARK" RESECTOSCOPES (MONOPOLAR/BIPOLAR)

1.11

Direction of view 0°		Handle variants	Cutting	Product no.
Active working element mono 0° Cut is made against spring pressure		Handle closed	Active	8681205*
Passive working element mono 0° Cut is made with spring pressure		Handle open	Passive	8681224*

* Not suitable for 22/24 Fr Double sheath system

Direction of view 12°/30°		Handle variants	Cutting	Product no.
Active working element mono 12/30° Cut is made against spring pressure		Handle closed	Active	8674205
Active working element mono 12/30° Cut is made against spring pressure		Handle closed with comfort thumb rest		8674234
Passive working element mono 12/30° Cut is made with spring pressure		Handle open	Passive	8674224
Passive working element mono 12/30° Cut is made with spring pressure		Handle closed		8674225

Recommended accessories		Product no.
Rubber cap, red (Pack = 5 PCS)	for sealing off the electrode clamping mechanism on the working element	8874
Thumb ring	with relatively large inner diameter	15008.159



BIPOLAR WORKING ELEMENTS

FOR RESECTOSCOPES, BIPOLAR
TELESCOPE 4 MM, 0°, 12°, 30°

Direction of view 0°/12°/30°		Handle variants	Cutting	Product no.
Active working element bipo 0/12/30° Cut is made against spring pressure		Handle open	Active	8680.204
Active working element bipo 0/12/30° Cut is made against spring pressure		Handle closed		8680.205
Passive working element bipo 0/12/30° Cut is made with spring pressure		Handle open	Passive	8680.224
Passive working element bipo 0/12/30° Cut is made with spring pressure		Handle closed		8680.225

Recommended accessories		Product no.
Rubber cap, black (Pack = 5 PCS)	for sealing off the electrode clamping mechanism on the working element	8880
Thumb ring	with relatively large inner diameter	15008.159

"SHARK" RESECTOSCOPES (MONOPOLAR/BIPOLAR)

1.11

IX23 || Subject to modifications. Please note that some products may not be available in all countries. Please always take note of the information that is provided with the product. For more detailed information, please consult with your contact partner or directly with Richard Wolf GmbH.

E-line

MONOPOLAR WORKING ELEMENTS

FOR RESECTOSCOPE, LONG SHEATH MONOPOLAR TELESCOPE 4 MM, 25°

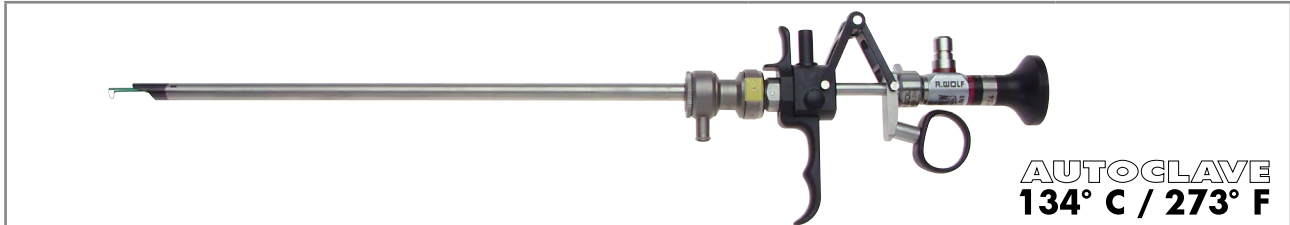





**AUTOCLAVE
134° C / 273° F**

II Sheath with distal ceramic insulation, rotatable irrigation ring



Distal end

for sheath sizes		SL/WL	Color coding	Product no.
 24 Fr	Long sheath for resectoscope 24 Fr	SL 257 mm	Yellow	8668.024
Also:				
	Obturator for resectoscope 24 Fr	WL 279 mm	Yellow	8668.12
	Cutting electrode mono 24 Fr 25°, round loop	-	Branch, green Stem, red	8439.03

Direction of view 25°		Handle variants	Cutting	Product no.
Active working element mono 25° Cut is made against spring pressure		Handle open	Active	8668.204
Passive working element mono 25° Cut is made with spring pressure		Handle closed	Passive	8668.225
Recommended accessories				Product no.
Thumb ring with relatively large inner diameter				15008.159

	Direction of view	∅	WL	TL	Product no.
Telescope 25° ∅ 4 mm WL 342 mm	0°	4.0 mm	342 mm	404 mm	8668.433



Recommended accessories		Product no.
Perforated basket for standard telescope 2	Internal dimensions (W x H x D): 454 x 52 x 40 mm External dimensions (W x H x D): 481 x 54 x 59 mm	38016
Fiber light cable bndl consisting of: Fiber light cable (80662523), projector-side adapter (8095.07), and endoscope-side adapter (809509)	∅ 2.5 mm, 2.3 m long	806625231
Monopolar connection cable		see UR0103/104

IX23 || Subject to modifications. Please note that some products may not be available in all countries. Please always take note of the information that is provided with the product. For more detailed information, please consult with your contact partner or directly with Richard Wolf GmbH.

"E-LINE" RESECTOSCOPE LONG SHEATH

1.12

MIDI size

RESECTOSCOPE

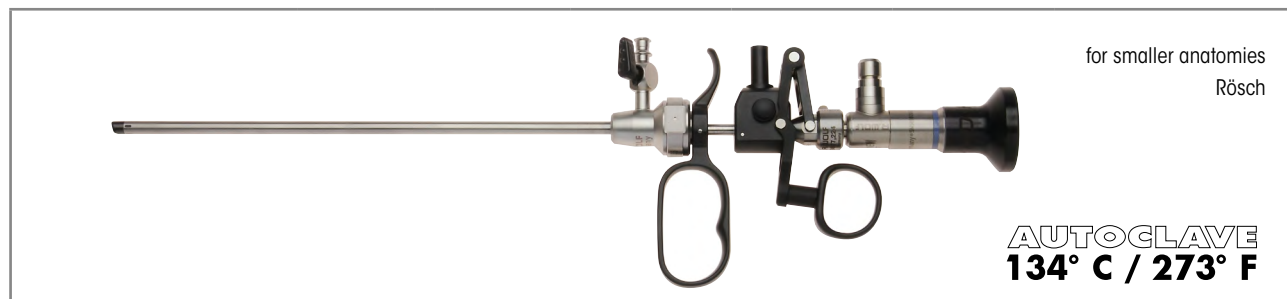

	consisting of:	Product no.
Sheath for resectoscope 14.5 Fr with irrigation valve	Sheath for resectoscope 14.5 Fr (86770155), obturator for resectoscope 14.5 Fr (86770157), tube with LUER-LOCK connector (886.00)	86770151

Also: individual sheaths and obturators



Individual sheath and obturator	SL/WL	Color coding	Product no.	Working element, active, mono 0°
Sheath for resectoscope 14.5 Fr	SL 221 mm	White	86770155	8677.224
Obturator for resectoscope 14.5 Fr	WL 240 mm	White	86770157	

Also: 

PANOVIEW telescope	Ø	WL	TL	Product no.
Telescope 0° Ø 2.7 mm WL 267 mm	2.7 mm	267 mm	334 mm	8672430



Recommended accessories	Product no.
Perforated basket for standard telescope 2	Internal dimensions (W x H x D): 454 x 52 x 40 mm External dimensions (W x H x D): 481 x 54 x 59 mm 38016
Fiber light cable bndl consisting of: Fiber light cable (80662523), projector-side adapter (8095.07), and endoscope-side adapter (809509)	Ø 2.5 mm, 2.3 m long 806625231
Container (W x H x D) 300 x 60 x 200 mm	33020
Monopolar connection cable	see UR0103/104



"MIDI-SIZE" RESECTOSCOPE



1.13

IX23 || Subject to modifications. Please note that some products may not be available in all countries. Please always take note of the information that is provided with the product. For more detailed information, please consult with your contact partner or directly with Richard Wolf GmbH.

MIDI size

AUXILIARY INSTRUMENTS

Stricture scalpels with ceramic cutter		Cutting surface	Product no.
	Scalpel 14.5 Fr, lancet-shaped	Lancet-shaped, cuts on both sides	8677981
	Scalpel 14.5 Fr, sickle-shaped	Sickle-shaped	8677931

Electrodes		Electrode shape	Product no.
	Coag. electrode mono 14.5 Fr 0° Stem color yellow	Button	8416011
	Cutting electrode mono 14.5 Fr 0° Stem color yellow	Round loop	8416031
	Hook electrode mono 14.5 Fr 0° Stem color yellow	Hook	8416091

IX23 || Subject to modifications. Please note that some products may not be available in all countries. Please always take note of the information that is provided with the product. For more detailed information, please consult with your contact partner or directly with Richard Wolf GmbH.

System blue

SYSTEM COMPONENTS

FOR PHOTODYNAMIC DIAGNOSTICS (PDD)

ix23 || Subject to modifications. Please note that some products may not be available in all countries. Please always take note of the information that is provided with the product. For more detailed information, please consult with your contact partner or directly with Richard Wolf GmbH.

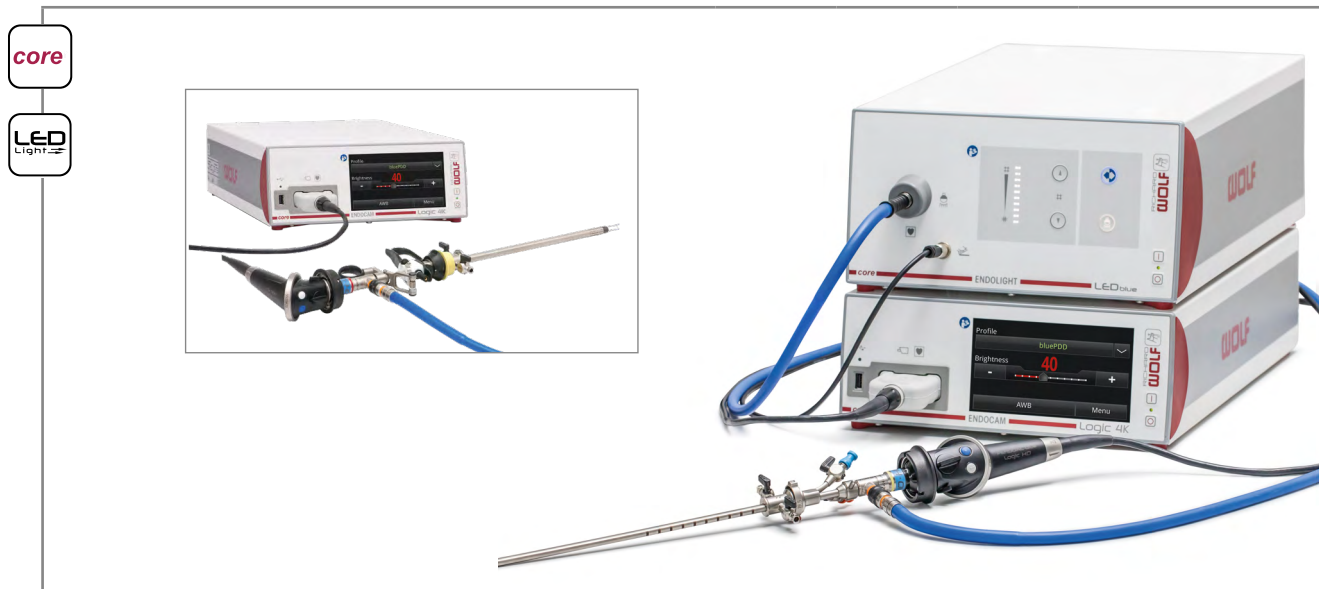

				Product no.
ENDOLIGHT LED blue bndl consisting of: ENDOLIGHT LED blue (5165001), patch cable, RJ45 SFTP, 0.5 m (72325378), toggle footswitch (2030.105), and power cable 3 m long (2440.03)				51650011
ENDOCAM Logic 4K camera control unit bndl consisting of: ENDOCAM Logic 4K camera control unit (5525301), handheld remote control (5525401), USB flash memory 32 GB (72321829), HDMI/HDMI cable, lockable, 3.0 m (103847), and power cable (2440.03)				55253011
ENDOCAM Logic HD Pendual camera head blue Cable length 3 m				5525833
Also:				
PANOVIEW	Ø	WL	TL	Product no.
Telescope blue 0° Ø 4 mm WL 298 mm	4.0 mm	298 mm	365 mm	8650.514
Telescope blue 12° Ø 4 mm WL 298 mm		298 mm	363 mm	8654.531
Telescope blue 30° Ø 4 mm WL 299 mm		299 mm	364 mm	8654.522
Telescope blue 70° Ø 4 mm WL 303 mm		303 mm	362 mm	8650.515
Special fiber light cable 3.5 mm, 2.3 m set consisting of: Fiber light cable blue Ø 3.5 mm (80673523), endoscope-side adapter (809509)	3.5 mm		2.3 m	806735231

"SYSTEM BLUE" FOR PHOTODYNAMIC DIAGNOSTICS (PDD)

1.14

System blue

SYSTEM COMPONENTS FOR PHOTODYNAMIC DIAGNOSTICS (PDD)

TUR-B (MONOPOLAR RESECTION OF BLADDER TUMORS)

Transurethral resection of the bladder (TUR-B)		Product no.
Recommendation: TUR-B/monopolar SHARK continuous irrigation resectoscope 22/24 Fr, 30°, for monopolar resection of bladder tumors		
 	Working element, active, mono 12/30° Active, closed	8674205
	Optional: working element, passive, mono 12/30° Passive, closed	8674225
	Outer sheath for resectoscope 24 Fr	8675424
	Inner sheath for resectoscope 22 Fr	8675322
	Obturator for resectoscope 22 Fr	8673022
	Viewing obturator for resectoscope 22 Fr	8673122
	Special fiber light cable 3.5 mm, 2.3 m SET	806735231
	Telescope blue 30° Ø 4 mm WL 299 mm	8654.522
	Optional: telescope blue 12° Ø 4 mm WL 298 mm	8654.531
	Cutting electrode mono 22 Fr 12/30° In individual sterile packaging (Pack = 10 PCS)	46782225
Coag. electrode mono 22–24 Fr 12/30° In individual sterile packaging (Pack = 5 PCS)	46782201	
Recommendation: TUR-B/monopolar SHARK continuous irrigation resectoscope 24/26 Fr, 30°, for monopolar resection of bladder tumors		
 	Working element, active, mono 12/30° Active, closed	8674205
	Optional: working element, passive, mono 12/30° Passive, closed	8674225
	Outer sheath for resectoscope 26 Fr	8675426
	Inner sheath for resectoscope 24 Fr	8675324
	Obturator for resectoscope 24 Fr	8673024
	Viewing obturator for resectoscope 24 Fr	8673124
	Dilatations obturator f. resectoscope 24 Fr	8673224
	Special fiber light cable 3.5 mm, 2.3 m SET	806735231
	Telescope blue 30° Ø 4 mm WL 299 mm	8654.522
	Optional: telescope blue 12° Ø 4 mm WL 298 mm	8654.531
Cutting electrode mono 24 Fr 12/30° In individual sterile packaging (Pack = 10 PCS)	46782425	

IX23 || Subject to modifications. Please note that some products may not be available in all countries. Please always take note of the information that is provided with the product. For more detailed information, please consult with your contact partner or directly with Richard Wolf GmbH.

"SYSTEM BLUE" FOR PHOTODYNAMIC DIAGNOSTICS (PDD)





1.14

System blue

SYSTEM COMPONENTS FOR PHOTODYNAMIC DIAGNOSTICS (PDD)

TUR-B (BIPOLAR RESECTION OF BLADDER TUMORS)

IX23 || Subject to modifications. Please note that some products may not be available in all countries. Please always take note of the information that is provided with the product. For more detailed information, please consult with your contact partner or directly with Richard Wolf GmbH.

Transurethral resection of the bladder (TUR-B)		Product no.
Recommendation: TUR-B/bipolar SHARK continuous irrigation resectoscope 22/24 Fr, 30°, for bipolar resection of bladder tumors		
 	Working element, active, bipo 0/12/30° Active, closed	8680.205
	Optional: working element, passive, bipo 0/12/30° Passive, closed	8680.225
	Outer sheath for resectoscope 24 Fr	8675424
	Inner sheath for resectoscope 22 Fr	8675322
	Obturator for resectoscope 22 Fr	8673022
	Viewing obturator for resectoscope 22 Fr	8673122
	Special fiber light cable 3.5 mm, 2.3 m SET	806735231
	Telescope blue 30° Ø 4 mm WL 299 mm	8654.522
	Optional: telescope blue 12° Ø 4 mm WL 298 mm	8654.531
	Cutting electrode bipo 22 Fr 12/30° In individual sterile packaging (Pack = 3 PCS)	4622.2533
	Cutting electrode bipo 22 Fr 12/30° In individual sterile packaging (Pack = 3 PCS)	4622.1333
	Coag. electrode bipo 22 Fr 12/30° In individual sterile packaging (Pack = 3 PCS)	4623.0243
Recommendation: TUR-B/bipolar SHARK continuous irrigation resectoscope 24/26 Fr, 30°, for bipolar resection of bladder tumors		
 	Working element, active, bipo 0/12/30° Active, closed	8680.205
	Optional: working element, passive, bipo 0/12/30° Passive, closed	8680.225
	Outer sheath for resectoscope 26 Fr	8675426
	Inner sheath for resectoscope 24 Fr	8675324
	Obturator for resectoscope 24 Fr	8673024
	Viewing obturator for resectoscope 24 Fr	8673124
	Special fiber light cable 3.5 mm, 2.3 m SET	806735231
	Telescope blue 30° Ø 4 mm WL 299 mm	8654.522
	Optional: telescope blue 12° Ø 4 mm WL 298 mm	8654.531
	Optional: telescope blue 12° Ø 4 mm WL 298 mm	8654.531
	Cutting electrode bipo 24–26 Fr 12/30° In individual sterile packaging (Pack = 3 PCS)	4622.2513
	Cutting electrode bipo 24 Fr 12/30° In individual sterile packaging (Pack = 3 PCS)	4622.1313
	Cutting electrode bipo 24–26 Fr 12/30° (oval, specifically for en bloc resection) In individual sterile packaging (Pack = 3 PCS)	4622.1323
Cutting electrode bipo 24–26 Fr 12/30° In individual sterile packaging (Pack = 3 PCS)	4623.0223	

"SYSTEM BLUE" FOR PHOTODYNAMIC DIAGNOSTICS (PDD)

1.14



MONOPOLAR ELECTRODES

FOR MULTIPLE USE

12°/30°



spirit of excellence

12°/30°, for multiple use, monopolar

	Designation	Bracket	for sheath sizes [in Fr]				Color coding		Model
			CI 22/24	II 24	CI 24/26	II 26	Branch	Stem	
	Cutting electrode mono 22 Fr 12/30°	Loop Ø 0.35 mm	●	–	–	–	Green	Dark gray	86782235
	Cutting electrode mono 24 Fr 12/30°		–	●	●	–	Yellow	Dark gray	86782435
	Cutting electrode mono 26 Fr 12/30°		–	–	–	●	Black	Dark gray	86782635
	Cutting electrode mono 24 Fr 12/30°	Loop Ø 0.8 mm	–	●	●	–	Yellow	Dark gray	86782480
	Coag. electrode mono 22–24 Fr 12/30°	Roller	●	●	●	–	Green	Dark gray	86782201
	Coag. electrode mono 26 Fr 12/30°		–	–	–	●	Black	Dark gray	86782601
	Coag. electrode mono 22–24 Fr 12/30°	Ball	●	●	●	–	Green	Dark gray	86782202
	Coag. electrode mono 22–24 Fr 12/30°	Button	●	●	●	–	Green	Dark gray	86782203
	Coag. electrode mono 26 Fr 12/30°		–	–	–	●	Black	Dark gray	86782603
	Knife electrode mono 22–24 Fr 12/30°	Knife	●	●	●	–	Green	Dark gray	86782204
	Knife electrode mono 26 Fr 12/30°		–	–	–	●	Black	Dark gray	86782604
	Hook electrode mono 22–24 Fr 12/30°	Hook	●	●	●	–	Green	Dark gray	86782205
	Hook electrode mono 26 Fr 12/30°		–	–	–	●	Black	Dark gray	86782605

● Suitable for corresponding sheath size – Not suitable

CI = continuous irrigation

II = intermittent irrigation

Recommended accessories

Product no.

Protective sterilization sleeve
Receptacle for max. 5 electrodes, reusable



AUTOCLAVE
134° C / 273° F

33030



MONOPOLAR ELECTRODES

FOR MULTIPLE USE

12°/30°

12°/30°, for multiple use, monopolar

	Designation	Bracket	for sheath sizes [in Fr]				Color coding		Model
			CI 22/24	II 24	CI 24/26	II 26	Branch	Stem	
	EVAP-Elektrode mono 24–26 Fr 12/30°	Barrel	–	•	•	•	Yellow	Dark gray	86782407
	EVAP-Elektrode mono 24–26 Fr 12/30°	Pyramid	–	•	•	•	Yellow	Dark gray	86782408
	Wing electrode mono 22 Fr 12/30°	Wing	•	–	–	–	Green	Dark gray	86782206
	EVAP-Elektrode mono 24 Fr 12/30°	(bracket profile, flat)	–	•	•	–	Yellow	Dark gray	86782406

• Suitable for corresponding sheath size – Not suitable

CI = continuous irrigation

II = intermittent irrigation

Recommended accessories	Product no.
Protective sterilization sleeve Receptacle for max. 5 electrodes, reusable  AUTOCLAVE 134° C / 273° F	33030

ix23 || Subject to modifications. Please note that some products may not be available in all countries. Please always take note of the information that is provided with the product. For more detailed information, please consult with your contact partner or directly with Richard Wolf GmbH.



MONOPOLAR ELECTRODES

FOR MULTIPLE USE

0°

0°, for multiple use, monopolar

	Designation	Bracket	for sheath sizes [in Fr]				Color coding		Model
			CI 22/24	II 24	CI 24/26	II 26	Branch	Stem	
	Cutting electrode mono 24 Fr 0°	Loop Ø 0.35 mm	-	●	●	-	Yellow	Dark gray	86792435
	Cutting electrode mono 26 Fr 0°		-	-	-	●	Black	Dark gray	86792635
	Coag. electrode mono 24 Fr 0°	Roller	-	●	●	-	Green	Dark gray	86792201
	Coag. electrode mono 24-26 Fr 0°	Ball	-	●	●	●	Transparent	Dark gray	86792202
	EVAP-Elektrode mono 24-26 Fr 0°	Barrel	-	●	●	●	Yellow	Dark gray	86792407
	Knife electrode mono 24-26 Fr 0°	Knife	-	●	●	●	Transparent	Dark gray	86792204
	Hook electrode mono 24-26 Fr 0°	Hook	-	●	●	●	Transparent	Dark gray	86792205

● Suitable for corresponding sheath size - Not suitable

CI = continuous irrigation

II = intermittent irrigation

"SHARK" ELECTRODES (MONOPOLAR/BIPOLAR) – "E-LINE" ELECTRODES

1.15

Recommended accessories	Product no.
Protective sterilization sleeve Receptacle for max. 5 electrodes, reusable	 AUTOCLAVE 134° C / 273° F
	33030

IX23 || Subject to modifications. Please note that some products may not be available in all countries. Please always take note of the information that is provided with the product. For more detailed information, please consult with your contact partner or directly with Richard Wolf GmbH.









MONOPOLAR ELECTRODES

FOR SINGLE USE
12°/30°



spirit of excellence

12°/30°, for single use, sterile*, monopolar

	Designation (Pack = 5 PCS)	Bracket	for sheath sizes [in Fr]				Color coding		Model
			CI 22/24	II 24	CI 24/26	II 26	Branch	Stem	
	Cutting electrode mono 22 Fr 12/30°	Loop Ø 0.35 mm	●	–	–	–	Green	Transparent	46782235
	Cutting electrode mono 24 Fr 12/30°		–	●	●	–	Yellow	Transparent	46782435
	Cutting electrode mono 26 Fr 12/30°		–	–	–	●	Black	Transparent	46782635
	Cutting electrode mono 22 Fr 12/30°	Loop Ø 0.25 mm	●	–	–	–	Green	Transparent	46782225
	Cutting electrode mono 24 Fr 12/30°		–	●	●	–	Yellow	Transparent	46782425
	Cutting electrode mono 24 Fr 12/30°	Loop Ø 0.8 mm	–	●	●	–	Yellow	Transparent	46782480
	Hook electrode mono 24 Fr 12/30°	Hook	●	●	●	–	Green	Transparent	46782205
	Hook electrode mono 26 Fr 12/30°		–	–	–	●	Black	Transparent	46782605
	Coag. electrode mono 22–24 Fr 12/30°	Roller	●	●	●	–	Green	Transparent	46782201
	Coag. electrode mono 22–24 Fr 12/30°	Ball	●	●	●	–	Green	Transparent	46782202
	Coag. electrode mono 22–24 Fr 12/30°	Button	●	●	●	–	Green	Transparent	46782203
	Coag. electrode mono 26 Fr 12/30°		–	–	–	●	Black	Transparent	46782603
	Knife electrode mono 22–24 Fr 12/30°	Knife	●	●	●	–	Green	Transparent	46782204
	Knife electrode mono 26 Fr 12/30°		–	–	–	●	Black	Transparent	46782604

● Suitable for corresponding sheath size – Not suitable

* In individual sterile packaging

CI = continuous irrigation

II = intermittent irrigation

"SHARK" ELECTRODES (MONOPOLAR/BIPOLAR) – "E-LINE" ELECTRODES

1.15



MONOPOLAR ELECTRODES

FOR SINGLE USE

0°

0°, for single use, sterile*, monopolar

	Designation (Pack = 5 PCS)	Bracket	for sheath sizes [in Fr]				Color coding		Model
			CI 22/24	II 24	CI 24/26	II 26	Branch	Stem	
	Cutting electrode mono 24 Fr 0°	Loop	-	●	●	-	Yellow	Transparent	46792435
	Cutting electrode mono 26 Fr 0°	Ø 0.35 mm	-	-	-	●	Black	Transparent	46792635
	Hook electrode mono 24 Fr 0°	Hook	-	●	●	-	Transparent	Transparent	46792205
	Coag. electrode mono 24 Fr 0°	Roller	-	●	●	-	Green	Transparent	46792201
	Knife electrode mono 24 Fr 0°	Knife	-	●	●	-	Transparent	Transparent	46792204

● Suitable for corresponding sheath size - Not suitable

* In individual sterile packaging

CI = continuous irrigation

II = intermittent irrigation

IX23 || Subject to modifications. Please note that some products may not be available in all countries. Please always take note of the information that is provided with the product. For more detailed information, please consult with your contact partner or directly with Richard Wolf GmbH.



BIPOLAR ELECTRODES

FOR MULTIPLE USE

0°/12°/30°

12°/30°, for multiple use, bipolar

	Designation	Bracket	for sheath sizes [in Fr]				Color coding		Model
			CI 22/24	II 24	CI 24/26	II 26	Branch	Stem	
	Cutting electrode bipo 22 Fr 12/30°	Loop Ø 0.3 mm	•	–	–	–	Blue	Yellow	8622133
	Cutting electrode bipo 24 Fr 12/30°		–	•	•	•	Blue	Yellow	8622131
	Coag. electrode bipo 22–26 Fr 12/30°	Cylinder Ø 1.2 mm	•	•	•	•	Blue	Yellow	8623022
	Hook electrode bipo 22–26 Fr 12/30°	Hook	•	•	•	•	Blue	Yellow	862309

0°, for multiple use, bipolar

	Designation	Bracket	for sheath sizes [in Fr]				Color coding		Model
			CI 22/24	II 24	CI 24/26	II 26	Branch	Stem	
	Cutting electrode bipo 24 Fr 0°	Loop Ø 0.3 mm	–	•	•	–	Blue	Yellow	8609031

• Suitable for corresponding sheath size – Not suitable

CI = continuous irrigation

II = intermittent irrigation

Recommended accessories	Product no.
Protective sterilization sleeve Receptacle for max. 5 electrodes, reusable  AUTOCLAVE 134° C / 273° F	33030



BIPOLAR ELECTRODES

FOR SINGLE USE

12°/30°

12°/30°, for single use, sterile*, bipolar

	Designation (Pack = 3 PCS)	Bracket	for sheath sizes [in Fr]				Color coding		Model
			CI 22/24	II 24	CI 24/26	II 26	Branch	Stem	
	Cutting electrode bipo 22 Fr 12/30°	Loop Ø 0.3 mm	●	–	–	–	Blue	Blue	4622.1333
	Cutting electrode bipo 24 Fr 12/30°		–	●	●	–	Blue	Blue	4622.1313
	Cutting electrode bipo 26 Fr 12/30°		–	–	●	●	Green	Blue	4624.1313
	Cutting electrode bipo 22 Fr 12/30°	Loop Ø 0.25 mm	●	–	–	–	Blue	Blue	4622.2533
	Cutting electrode bipo 24–26 Fr 12/30°		–	●	●	●	Blue	Blue	4622.2513
	Cutting electrode bipo 24–26 Fr 12/30° Oval, specifically for en bloc resection	Loop Ø 0.3 mm	–	●	●	●	Blue	Blue	4622.1323
	Coag. electrode bipo 22 Fr 12/30°	Cylinder Ø 1.2 mm	●	–	–	–	Blue	Blue	4623.0243
	Coag. electrode bipo 24–26 Fr 12/30°		–	●	●	●	Blue	Blue	4623.0223
	BiVAP-Elektrode bipo 22 Fr 12/30°	Torus	●	–	–	–	Blue	Blue	46300223
	BiVAP-Elektrode bipo 24–26 Fr 12/30°		–	●	●	●	Blue	Blue	46300243
	Enucleation electrode bipo 22 Fr 12/30°	Torus	●	–	–	–	Blue	Blue	46400223
	Enucleation electrode bipo 24 Fr 12/30°		–	●	●	●	Blue	Blue	46400243

● Suitable for corresponding sheath size – Not suitable

* In individual sterile packaging

CI = continuous irrigation

II = intermittent irrigation

IX23 || Subject to modifications. Please note that some products may not be available in all countries. Please always take note of the information that is provided with the product. For more detailed information, please consult with your contact partner or directly with Richard Wolf GmbH.

"SHARK" ELECTRODES (MONOPOLAR/BIPOLAR) – "E-LINE" ELECTRODES

1.15



BIPOLAR ELECTRODES

FOR SINGLE USE

0°

0°, for single use, sterile*, bipolar

	Designation (Pack = 3 PCS)	Bracket	for sheath sizes [in Fr]				Color coding		Model
			CI 22/24	II 24	CI 24/26	II 26	Branch	Stem	
	Cutting electrode bipo 24 Fr 0°	Loop	-	•	•	-	Blue	Blue	4609.0313
	Cutting electrode bipo 26 Fr 0°	Ø 0.3 mm	-	-	-	•	Green	Blue	4611.0313
	Cutting electrode bipo 24 Fr 0°	Loop Ø 0.25 mm	-	•	•	-	Blue	Blue	4609.2513
	Cutting electrode bipo 24-26 Fr 0°	Loop Ø 0.3 mm	-	•	•	•	Blue	Blue	4609.0323
	Coag. electrode bipo 24-26 Fr 0°	Cylinder Ø 1.2 mm	-	•	•	•	Blue	Blue	4610.0223
	BiVAP-Elektrode bipo 24-26 Fr 0°	Torus	-	•	•	•	Blue	Blue	46310243

• Suitable for corresponding sheath size - Not suitable

* In individual sterile packaging

CI = continuous irrigation



II = intermittent irrigation

E-line

MONOPOLAR ELECTRODES

FOR RESECTOSCOPES, TELESCOPE 4 MM,
25°, LONG SHEATH

25°, for multiple use, monopolar

	Designation	Bracket	 24	Color coding		Model
				Branch	Stem	
	Cutting electrode mono 24 Fr 25°	Loop Ø 0.3 mm	•	Green	Red	8439.03
	Coag. electrode mono 24 Fr 25°	Roller	•	Blue	Red	8440.02

"SHARK" ELECTRODES (MONOPOLAR/BIPOLAR) – "E-LINE" ELECTRODES

1.15













Recommended accessories	Product no.
<p>Protective sterilization sleeve Receptacle for max. 5 electrodes, reusable</p>  <p>AUTOCLAVE 134° C / 273° F</p>	33030

IX23 || Subject to modifications. Please note that some products may not be available in all countries. Please always take note of the information that is provided with the product. For more detailed information, please consult with your contact partner or directly with Richard Wolf GmbH.

ACCESSORIES

FOR RESECTOSCOPE SHEATHS



for sheath sizes [in Fr]		Via	Working units of cysto-urethroscope 8650 for use in resectoscope sheaths		with telescope Ø 4 mm	
 24/26 Fr	 26 Fr		Version	Product no.		
•	•	Only for diagnostics	 Adapter with instrument port	8652.264	0°, 12°, 30°, 70°	
•	•	Adapter for E-Line sheaths 8652  8652.704	 Opt. scissors, "Wuppertal" model	8650.644	0°	
-	•		 Opt. biopsy forceps, "Marburg" model	8650.614	0°	
-	•		 Opt. grasping forceps, curved downward	8650.654	0°	
-	•		 Opt. biopsy forceps, spoon downward	8650.774	0°	
-	•		 Opt. grasping forceps, straight	8650.684	0°	
-	•		 Opt. biopsy forceps, spoon-shaped	8650.604	0°	
-	•		 Opt. coag. biopsy forceps, Tauber	8650.624	0°	
-	•		without adapter	 Working insert for cystoscope 0/30/70* or working insert for cystoscope 30/70**	8650.204* or 8650.214**	(0°, 12°) 30°, 70°

 = intermittent irrigation

 = continuous irrigation



"SHARK" ELECTRODES (MONOPOLAR/BIPOLAR) – "E-LINE" ELECTRODES

1.15

IX23 || Subject to modifications. Please note that some products may not be available in all countries. Please always take note of the information that is provided with the product. For more detailed information, please consult with your contact partner or directly with Richard Wolf GmbH.







ACCESSORIES

FOR RESECTOSCOPE SHEATHS 
WITH 4 MM TELESCOPE

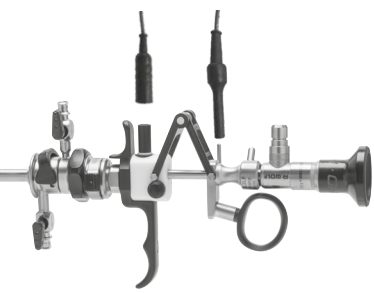
		Ø	for sheaths	
			with rotatable and replaceable irrigation ring Capacity 4 mm	with fixed Luer stopcock Capacity 3 mm
	Two-way stopcock, maintenance-free with LUER-LOCK connection, reusable	3 mm		88350
		4 mm	88351	
	Stopcock LUER-LOCK connection Ø 3 mm	3 mm		884.00
	Stopcock LUER-LOCK connection Ø 4 mm	4 mm	884.01	
	Tube with LUER-LOCK connector	3 mm		886.00

IX23 || Subject to modifications. Please note that some products may not be available in all countries. Please always take note of the information that is provided with the product. For more detailed information, please consult with your contact partner or directly with Richard Wolf GmbH.

ACCESSORIES
HF CONNECTION CABLE BIPO
FOR RESECTION IN SALINE SOLUTION

Instrument connector	Device connector		Product no.
 <p>WOLF S(a)line resectoscopes</p>	 Erbe VIO 300D	<p>Bipolar cable; TUR/TCR; WOLF MF plug; L 4 m</p>	<p>20196-119</p>
	 Erbe VIO 3	<p>Bipolar cable; MF-U MF plug; L 4.5 m</p>	<p>21196-119</p>
	 KLS Martin	<p>HF connection cable bipo; L 3 m</p>	<p>8108.231</p>
	 KLS Martin	<p>HF connection cable bipo; L 5 m</p>	<p>8108.251</p>
	 R. Wolf HF surgical generator 400 kHz 2260001/2260002	<p>HF connection cable bipo; L 3 m</p>	<p>8108233</p>
	 R. Wolf HF surgical generator 400 kHz 2260001/2260002	<p>HF connection cable bipo; L 5 m</p>	<p>8108253</p>

**GREENLIGHT™ CONTINUOUS IRRIGATION
LASER CYSTOSCOPE "MoXy™"**
PARTICULARLY FOR THE USE OF MOXY™ LASER FIBERS



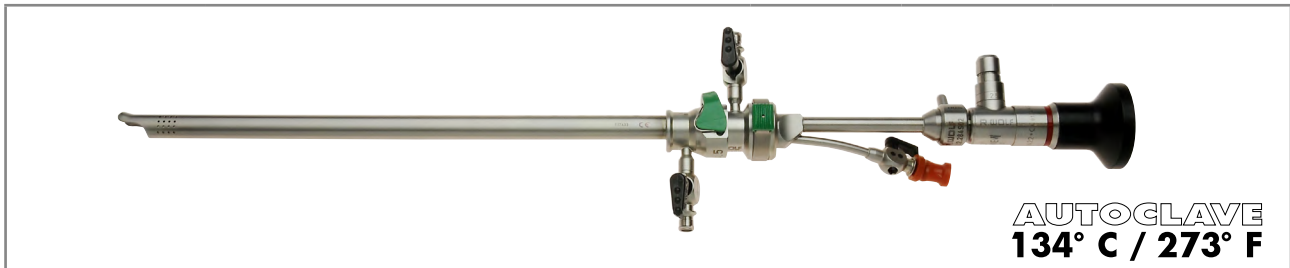

LASER ENUCLEATION

1.17



CI Double sheath system



for sheath sizes		SL/WL	Color coding	Product no.	
CI 24.4 Fr	Outer sheath for laser therapy 24.5 Fr	SL 205 mm	Green	8632028	
	Inner sheath for laser therapy	SL 217 mm		8632029	
Also:					
	Obturator for laser therapy 24.5 Fr	WL 220 mm	Green	8632128	
	Viewing obturator for laser therapy 24.5 Fr	WL 219 mm		8632728	
Working insert for freely controlling the laser fiber without a stop. Stabilizes the fiber tip incredibly well during GreenLight vaporization, for example				Product no.	
Laser working insert 12/30 "MoXy™" for flexible auxiliary instruments up to 6.5 Fr				8632.284	
Rubber cap for hysteroscope Extended, red-orange (1 PC)				18.01	
Also: 					
PANOVIEW	Direction of view	Ø	WL	TL	Product no.
Telescope 30° Ø 4 mm WL 300 mm	30°	4.0 mm	300 mm	364 mm	8654.422
Telescope 12° Ø 4 mm WL 297 mm	12°	4.0 mm	297 mm	363 mm	8654.431
Recommended accessories				Product no.	
Perforated basket for standard telescope 2		Internal dimensions (W x H x D): 454 x 52 x 40 mm External dimensions (W x H x D): 481 x 54 x 59 mm		38016	
Fiber light cable bndl consisting of: Fiber light cable (80662523), projector-side adapter (8095.07), and endoscope-side adapter (809509)		Ø 2.5 mm, 2.3 m long		806625231	

IX23 || Subject to modifications. Please note that some products may not be available in all countries. Please always take note of the information that is provided with the product. For more detailed information, please consult with your contact partner or directly with Richard Wolf GmbH.



GREENLIGHT™ CONTINUOUS IRRIGATION LASER RESECTOSCOPE "MoXy™"

PARTICULARLY FOR THE USE OF MOXY™ LASER FIBERS



CI Double sheath system

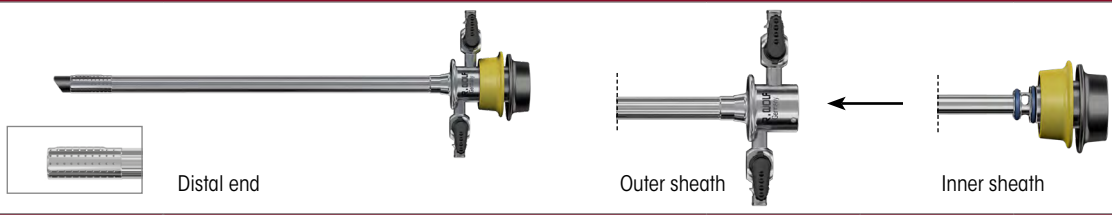

for sheath sizes		SL/WL	Color coding	Product no.
CI 24 Fr	Outer sheath for resectoscope 24 Fr	SL 189 mm	Green	8675424
	Inner sheath for resectoscope 22 Fr	SL 205 mm		8675322

Also:

	Obturator for resectoscope 22 Fr	WL 232 mm	Green	8673022
	Viewing obturator for resectoscope 22 Fr			8673122
CI 26 Fr	Outer sheath for resectoscope 26 Fr	SL 189 mm	Yellow	8675426
	Inner sheath for resectoscope 24 Fr	SL 205 mm		8675324

Also:

	Obturator for resectoscope 24 Fr	WL 233 mm	Yellow	8673024
	Viewing obturator for resectoscope 24 Fr	WL 232 mm		8673124
	Dilatations obturator f. resectoscope 24 Fr	WL 247 mm		8673224

Working insert for freely controlling the laser fiber without a stop. Stabilizes the fiber tip incredibly well during GreenLight vaporization, for example			Product no.
Laser working insert 12/30 "MoXy™" for flexible auxiliary instruments up to 6.5 Fr			8632.284
Rubber cap for hysteroscope, extended, red-orange (1 PC)			18.01

Also:

PANOVIEW	Direction of view	Ø	WL	TL	Product no.
Telescope 30° Ø 4 mm WL 300 mm	30°	4.0 mm	300 mm	364 mm	8654.422
Telescope 12° Ø 4 mm WL 297 mm	12°	4.0 mm	297 mm	363 mm	8654.431

Recommended accessories

		Product no.
Perforated basket for standard telescope 2	Internal dimensions (W x H x D): 454 x 52 x 40 mm External dimensions (W x H x D): 481 x 54 x 59 mm	38016
Fiber light cable bndl consisting of: Fiber light cable (80662523), projector-side adapter (8095.07), and endoscope-side adapter (809509)	Ø 2.5 mm, 2.3 m long	806625231

ix23 || Subject to modifications. Please note that some products may not be available in all countries. Please always take note of the information that is provided with the product. For more detailed information, please consult with your contact partner or directly with Richard Wolf GmbH.



**CONTINUOUS IRRIGATION LASER
ENUCLEATION SHEATH 26 Fr "MoXy™"**
FOR **BLUNT** ENUCLEATION OF THE PROSTATE



CI Double sheath system

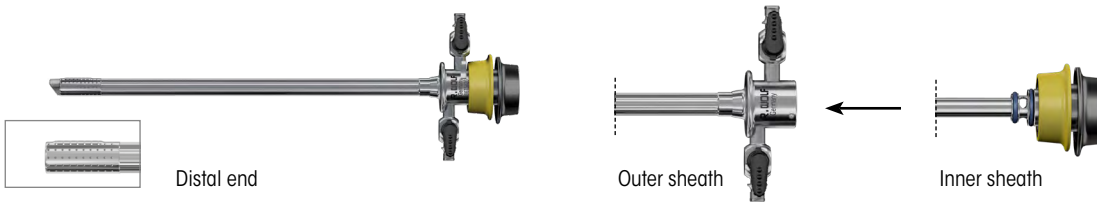

for sheath sizes		SL/WL	Color coding	Product no.
	Outer sheath for resectoscope 26 Fr	SL 189 mm	Yellow	8675426
	Inner sheath for laser therapy 24 Fr	SL 203 mm		8675524

Also:

	Obturator for resectoscope 24 Fr	WL 232 mm	Yellow	8673324
--	----------------------------------	-----------	--------	----------------

Working insert for freely controlling the laser fiber without a stop.
Stabilizes the fiber tip incredibly well during GreenLight vaporization, for example

Laser working insert 12/30
"MoXy™" for flexible auxiliary instruments up to 6.5 Fr



8632.284

Rubber cap for hysteroscope, extended, red-orange (1 PC)



18.01

Also:

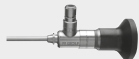

PANOVIEW	Direction of view	Ø	WL	TL	Product no.
Telescope 30° Ø 4 mm WL 300 mm	30°	4.0 mm	300 mm	364 mm	8654.422
Telescope 12° Ø 4 mm WL 297 mm	12°	4.0 mm	297 mm	363 mm	8654.431

Recommended accessories **Product no.**

Perforated basket for standard telescope 2	Internal dimensions (W x H x D): 454 x 52 x 40 mm External dimensions (W x H x D): 481 x 54 x 59 mm	38016
Fiber light cable bndl consisting of: Fiber light cable (80662523), projector-side adapter (8095.07), and endoscope-side adapter (809509)	Ø 2.5 mm, 2.3 m long	806625231

GREENLIGHT™ CONTINUOUS IRRIGATION LASER CYSTOSCOPE "Freestyle" PARTICULARLY FOR THE USE OF GREENLIGHT™ AND SIMILAR LASER FIBERS



CI Double sheath system



for sheath sizes		SL/WL	Color coding	Product no.
CI 22.5 Fr	Outer sheath for laser therapy 22.5 Fr	SL 196 mm	Green	8632.026
	Inner sheath for laser therapy	SL 209 mm		8632.027

Also:

	Obturator for laser therapy 22.5 Fr	WL 214 mm	Green	8632.126
	Viewing obturator for laser therapy 22.5 Fr			8632.726

CI 24.5 Fr	Outer sheath for laser therapy 24.5 Fr	SL 205 mm	Green	8632028
	Inner sheath for laser therapy	SL 217 mm		8632029

Also:

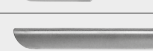
	Obturator for laser therapy 24.5 Fr	WL 220 mm	Green	8632128
	Viewing obturator for laser therapy 24.5 Fr	WL 219 mm		8632728

Working insert for freely controlling the laser fiber without a stop.

Product no.

Laser working insert 12/30 "Freestyle" for flexible auxiliary instruments up to 6.5 Fr		8632.914
--	--	-----------------

Also: 

PANOVIEW	Direction of view	Ø	WL	TL	Product no.
Telescope 30° Ø 4 mm WL 300 mm	30°	4.0 mm	300 mm	364 mm	8654.422
Telescope 12° Ø 4 mm WL 297 mm	12°	4.0 mm	297 mm	363 mm	8654.431

Recommended accessories Product no.

Perforated basket for standard telescope 2	Internal dimensions (W x H x D): 454 x 52 x 40 mm External dimensions (W x H x D): 481 x 54 x 59 mm	38016
Fiber light cable bndl consisting of: Fiber light cable (80662523), projector-side adapter (8095.07), and endoscope-side adapter (809509)	Ø 2.5 mm, 2.3 m long	806625231

IX23 || Subject to modifications. Please note that some products may not be available in all countries. Please always take note of the information that is provided with the product. For more detailed information, please consult with your contact partner or directly with Richard Wolf GmbH.



GREENLIGHT™ CONTINUOUS IRRIGATION LASER RESECTOSCOPE "Freestyle"

PARTICULARLY FOR THE USE OF GREENLIGHT™ AND SIMILAR LASER FIBERS



AUTOCLAVE
134° C / 273° F

CI Double sheath system

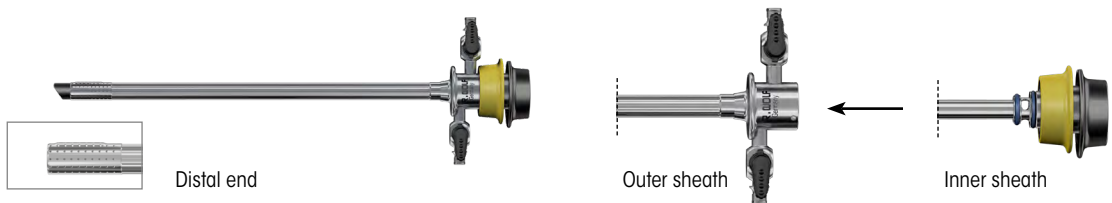

for sheath sizes		SL/WL	Color coding	Product no.
CI 24 Fr	Outer sheath for resectoscope 24 Fr	SL 189 mm	Green	8675424
	Inner sheath for resectoscope 22 Fr	SL 205 mm		8675322

Also:

	Obturator for resectoscope 22 Fr	WL 232 mm	Green	8673022
	Viewing obturator for resectoscope 22 Fr			8673122
CI 26 Fr	Outer sheath for resectoscope 26 Fr	SL 189 mm	Yellow	8675426
	Inner sheath for resectoscope 24 Fr	SL 205 mm		8675324

Also:

	Obturator for resectoscope 24 Fr	WL 233 mm	Yellow	8673024
	Viewing obturator for resectoscope 24 Fr	WL 232 mm		8673124
	Dilatations obturator f. resectoscope 24 Fr	WL 247 mm		8673224

Working insert for freely controlling the laser fiber without a stop.

	Product no.
Laser working insert 12/30 "Freestyle" for flexible auxiliary instruments up to 6.5 Fr	8632.914

Also:

PANOVIEW	Direction of view	Ø	WL	TL	Product no.
Telescope 30° Ø 4 mm WL 300 mm	30°	4.0 mm	300 mm	364 mm	8654.422
Telescope 12° Ø 4 mm WL 297 mm	12°	4.0 mm	297 mm	363 mm	8654.431

Recommended accessories

	Product no.
Perforated basket for standard telescope 2 Internal dimensions (W x H x D): 454 x 52 x 40 mm External dimensions (W x H x D): 481 x 54 x 59 mm	38016
Fiber light cable bndl consisting of: Fiber light cable (80662523), projector-side adapter (8095.07), and endoscope-side adapter (809509)	806625231

IX23 || Subject to modifications. Please note that some products may not be available in all countries. Please always take note of the information that is provided with the product. For more detailed information, please consult with your contact partner or directly with Richard Wolf GmbH.



CONTINUOUS IRRIGATION LASER ENUCLEATION SHEATH 26 Fr "Freestyle" FOR **BLUNT** ENUCLEATION OF THE PROSTATE



CI Double sheath system

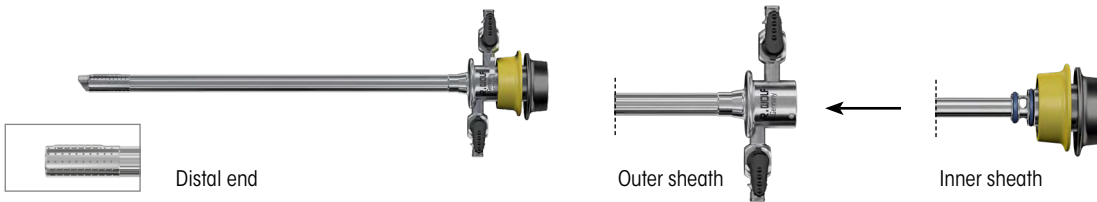

for sheath sizes		SL/WL	Color coding	Product no.
	Outer sheath for resectoscope 26 Fr	SL 189 mm	Yellow	8675426
	Inner sheath for laser therapy 24 Fr	SL 206 mm		8675524

Also:

	Obturator for resectoscope 24 Fr	WL 232 mm	Yellow	8673324
--	----------------------------------	-----------	--------	----------------

Working insert for freely controlling the laser fiber without a stop.

Product no.

Laser working insert 12/30

"Freestyle" for flexible auxiliary instruments up to 6.5 Fr



8632.914

Also:

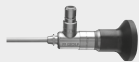

PANOVIEW	Direction of view	Ø	WL	TL	Product no.
Telescope 30° Ø 4 mm WL 300 mm	30°	4.0 mm	300 mm	364 mm	8654.422
Telescope 12° Ø 4 mm WL 297 mm	12°	4.0 mm	297 mm	363 mm	8654.431

Recommended accessories

Product no.

Perforated basket for standard telescope 2

Internal dimensions (W x H x D): 454 x 52 x 40 mm
External dimensions (W x H x D): 481 x 54 x 59 mm

38016

Fiber light cable bndl consisting of:

Fiber light cable (80662523), projector-side adapter (8095.07), and endoscope-side adapter (809509)

Ø 2.5 mm, 2.3 m long

806625231



CONTINUOUS IRRIGATION WORKING INSERT

FOR LASER PROBES UP TO 7.5 Fr

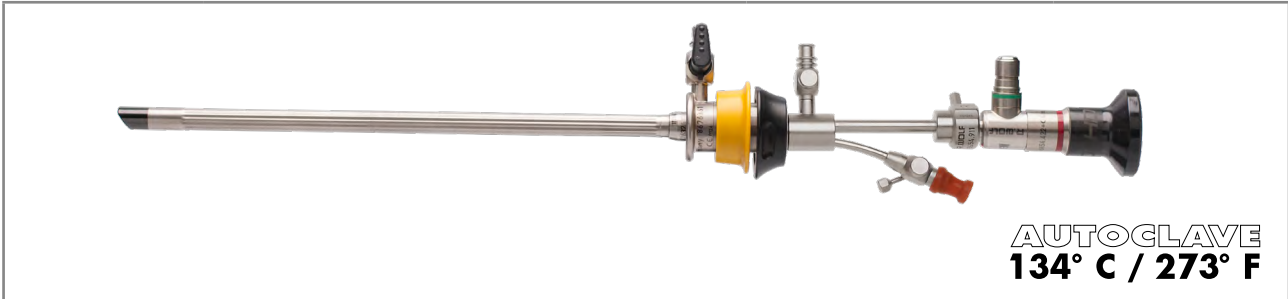

AUTOCLAVE
134° C / 273° F

II Sheath with rotatable irrigation adapter

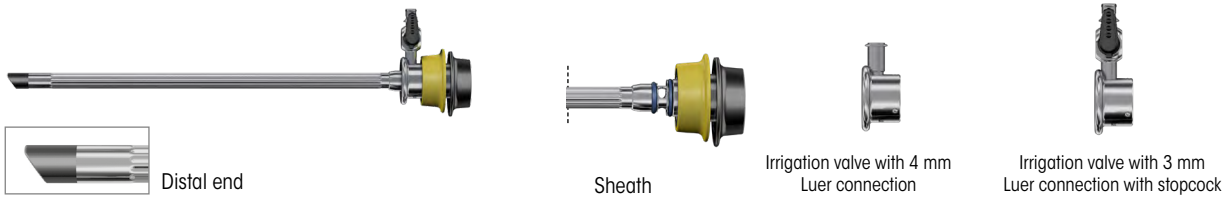

for sheath sizes		SL/WL	Color coding	Product no.
	Sheath for resectoscope 24 Fr	SL 200 mm	Yellow	8676324
	Irrigation adapter for resectoscope 24/26 Fr with 4 mm Luer connection			8676354*
	Irrigation adapter for resectoscope 24/26 Fr with 3 mm Luer connection with stopcock			8676361**

Also:

	Obturator for resectoscope 24 Fr	WL 233 mm	Yellow	8673024
	Viewing obturator for resectoscope 24 Fr	WL 232 mm		8673124
	Dilatations obturator f. resectoscope 24 Fr	WL 247 mm		8673224

* for connection to rotatable irrigation adapter 8676354: **Two-way stopcock, maintenance-free,** with LUER-LOCK connection **88351**

** for connection to rotatable irrigation adapter 8676361: **Two-way stopcock, maintenance-free,** with LUER-LOCK connection **88350**

Working insert for continuous irrigation with instrument port for flexible auxiliary instruments up to 7.5 Fr

		Product no.
Laser working insert 12/30 7.5 Fr		8654.911

Also:

PANOVIEW	Direction of view	Ø	WL	TL	Product no.
Telescope 30° Ø 4 mm WL 300 mm	30°	4.0 mm	300 mm	364 mm	8654.422
Telescope 12° Ø 4 mm WL 297 mm	12°	4.0 mm	297 mm	363 mm	8654.431

Recommended accessories

		Product no.
Perforated basket for standard telescope 2	Internal dimensions (W x H x D): 454 x 52 x 40 mm External dimensions (W x H x D): 481 x 54 x 59 mm	38016
Fiber light cable bndl consisting of: Fiber light cable (80662523), projector-side adapter (8095.07), and endoscope-side adapter (809509)	Ø 2.5 mm, 2.3 m long	806625231

IX23 || Subject to modifications. Please note that some products may not be available in all countries. Please always take note of the information that is provided with the product. For more detailed information, please consult with your contact partner or directly with Richard Wolf GmbH.



HOLEP, THULEP

CONTINUOUS IRRIGATION LASER ENUCLEATION SHEATH 26 Fr

FOR **BLUNT** ENUCLEATION OF THE PROSTATE



CI Double sheath system

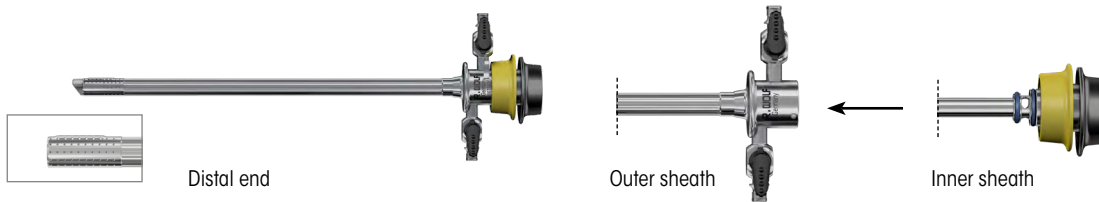

for sheath sizes		SL/WL	Color coding	Product no.
	Outer sheath for resectoscope 26 Fr	SL 189 mm	Yellow	8675426
	Inner sheath for laser therapy 24 Fr	SL 206 mm		8675524

Also:

	Obturator for resectoscope 24 Fr	WL 232 mm	Yellow	8673324
--	----------------------------------	-----------	--------	----------------

Working element

	Product no.
Laser working element, passive 12/30° with handle closed	8654382
Laser working insert 12/30°	8654383

Guide tubes



see UR084

Also:



PANOVIEW	Direction of view	Ø	WL	TL	Product no.
Telescope 30° Ø 4 mm WL 300 mm	30°	4.0 mm	300 mm	364 mm	8654.422
Telescope 12° Ø 4 mm WL 297 mm	12°	4.0 mm	297 mm	363 mm	8654.431

Recommended accessories

Product no.

Perforated basket for standard telescope 2	Internal dimensions (W x H x D): 454 x 52 x 40 mm External dimensions (W x H x D): 481 x 54 x 59 mm	38016
Fiber light cable bndl consisting of: Fiber light cable (80662523), projector-side adapter (8095.07), and endoscope-side adapter (809509)	Ø 2.5 mm, 2.3 m long	806625231



HOLEP, THULEP

CONTINUOUS IRRIGATION LASER ENUCLEATION SHEATH, 26 Fr

FOR ENUCLEATION OF THE PROSTATE



spirit of excellence

LASER ENUCLEATION

1.17

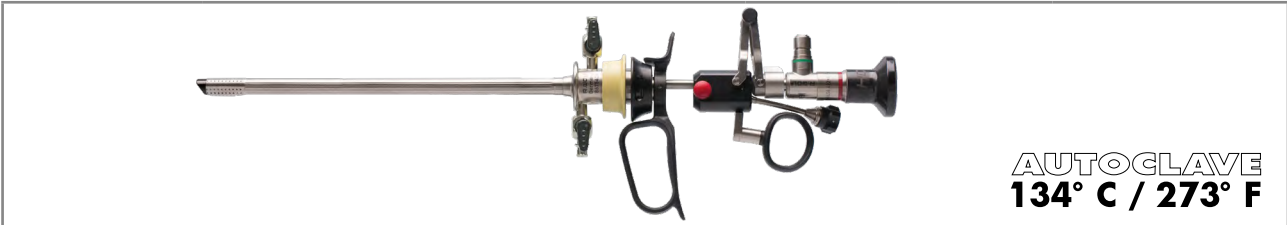

AUTOCLAVE
134° C / 273° F

CI Double sheath system

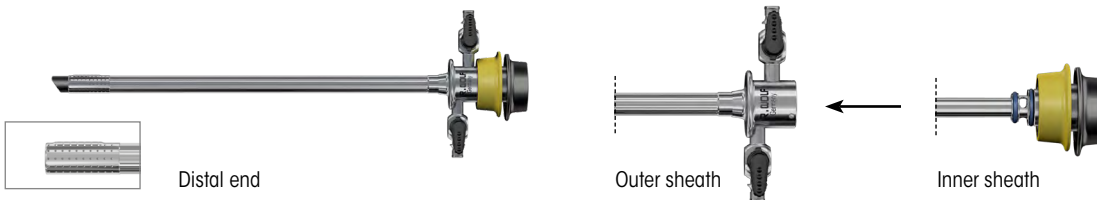





for sheath sizes		SL/WL	Color coding	Product no.	
CI 24 Fr	Outer sheath for resectoscope 24 Fr	SL 189 mm	Green	8675424	
	Inner sheath for resectoscope 22 Fr	SL 205 mm		8675322	
Also:					
	Obturator for resectoscope 22 Fr	WL 232 mm	Green	8673022	
	Viewing obturator for resectoscope 22 Fr			8673122	
CI 26 Fr	Outer sheath for resectoscope 26 Fr	SL 189 mm	Yellow	8675426	
	Inner sheath for resectoscope 24 Fr	SL 205 mm		8675324	
Also:					
	Obturator for resectoscope 24 Fr	WL 233 mm	Yellow	8673024	
	Viewing obturator for resectoscope 24 Fr	WL 232 mm		8673124	
	Dilatations obturator f. resectoscope 24 Fr	WL 247 mm		8673224	
Working element				Product no.	
Laser working element, passive 12/30° with handle closed				8654382	
Laser working insert 12/30°				8654383	
Guide tubes				see UR084	
Also:					
PANOVIEW	Direction of view	Ø	WL	TL	Product no.
Telescope 30° Ø 4 mm WL 300 mm	30°	4.0 mm	300 mm	364 mm	8654.422
Telescope 12° Ø 4 mm WL 297 mm	12°	4.0 mm	297 mm	363 mm	8654.431
Recommended accessories				Product no.	
Perforated basket for standard telescope 2		Internal dimensions (W x H x D): 454 x 52 x 40 mm External dimensions (W x H x D): 481 x 54 x 59 mm		38016	
Fiber light cable bndl consisting of: Fiber light cable (80662523), projector-side adapter (8095.07), and endoscope-side adapter (809509)		Ø 2.5 mm, 2.3 m long		806625231	

IX23 || Subject to modifications. Please note that some products may not be available in all countries. Please always take note of the information that is provided with the product. For more detailed information, please consult with your contact partner or directly with Richard Wolf GmbH.



LASER FIBER GUIDE TUBES

FOR CONTINUOUS IRRIGATION LASER ENUCLEATION SHEATH 26 Fr

Laser fiber guide tubes for inner sheath 24 Fr		Fr	Capacity	Product no.
 with lateral guide, distal end straight	Guide tube laser therapy 1,000 µm 22 Fr	22 Fr	1,000 µm	8654990
	Guide tube laser therapy 1,000 µm 24 Fr	24 Fr		8654991
 with lateral guide, distal end straight	Guide tube laser therapy 600 µm 22 Fr	22 Fr	600 µm	8654992
	Guide tube laser therapy 600 µm 24 Fr	24 Fr		8654993
 with lateral guide, distal end slanted	Guide tube laser therapy 600 µm 22 Fr	22 Fr	600 µm	8654994
	Guide tube laser therapy 600 µm 24 Fr	24 Fr		8654995
 with lateral guide, distal end with ring	Guide tube laser therapy 600 µm 22 Fr	22 Fr	600 µm	8654996
	Guide tube laser therapy 600 µm 24 Fr	24 Fr		8654997
 Curette 22–24 Fr for prostate chips		From 22 Fr	600 µm	8654998

Note: Laser fiber guide tubes can only be used in conjunction with the laser working element (8654382) and laser working insert (8654383).

IX23 || Subject to modifications. Please note that some products may not be available in all countries. Please always take note of the information that is provided with the product. For more detailed information, please consult with your contact partner or directly with Richard Wolf GmbH.



BIPOLAR ENUCLEATION

CONTINUOUS IRRIGATION LASER ENUCLEATION SHEATH, 24/26 Fr

FOR **BIPOLAR** ENUCLEATION OF THE PROSTATE



AUTOCLAVE
134° C / 273° F

CI Double sheath system

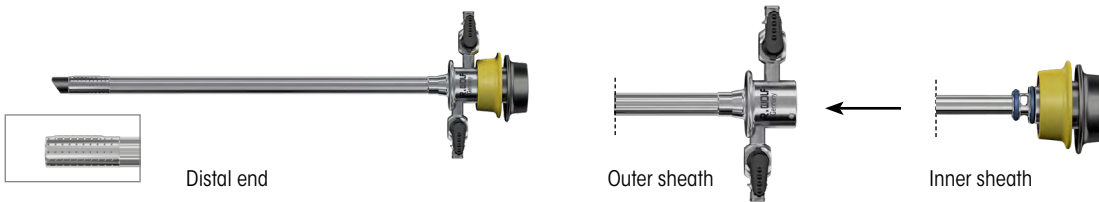

for sheath sizes		SL/WL	Color coding	Product no.
	Outer sheath for resectoscope 26 Fr	SL 189 mm	Yellow	8675426
	Inner sheath for resectoscope 24 Fr	SL 205 mm		8675324

Also:

	Obturator for resectoscope 24 Fr	WL 233 mm	Yellow	8673024
	Viewing obturator for resectoscope 24 Fr	WL 232 mm		8673124
	Dilatations obturator f. resectoscope 24 Fr	WL 247 mm		8673224

Working element			Product no.
Working element, active, bipo 0/12/30° with handle closed			8680.205

Enucleation electrode bipo 24 Fr 12/30°		46400243
---	--	-----------------

Also:

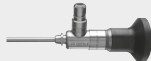

PANOVIEW	Direction of view	Ø	WL	TL	Product no.
Telescope 30° Ø 4 mm WL 300 mm	30°	4.0 mm	300 mm	364 mm	8654.422
Telescope 12° Ø 4 mm WL 297 mm	12°	4.0 mm	297 mm	363 mm	8654.431

Recommended accessories		Product no.
Perforated basket for standard telescope 2	Internal dimensions (W x H x D): 454 x 52 x 40 mm External dimensions (W x H x D): 481 x 54 x 59 mm	38016
Fiber light cable bndl consisting of: Fiber light cable (80662523), projector-side adapter (8095.07), and endoscope-side adapter (809509)		Ø 2.5 mm, 2.3 m long 806625231

IX23 || Subject to modifications. Please note that some products may not be available in all countries. Please always take note of the information that is provided with the product. For more detailed information, please consult with your contact partner or directly with Richard Wolf GmbH.







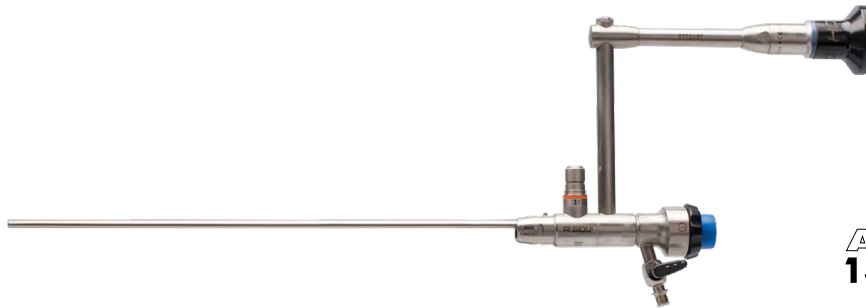

MORCESCOPE, 0°

IN COMBINATION WITH **SHARK** OUTER SHEATHS
FOR TISSUE MORCELLATION



AUTOCLAVE
134° C / 273° F

PANOVIEW		WL	TL	Product no.
Morcescope 0° 24 Fr WL 224 mm Rigid, with parallel eyepiece, working channel for instruments up to 4.8 mm, irrigation via 24.5/26 Fr sheath and adapter, suction via morcellator		224 mm	386 mm	8970405
Autom. sealing element ID 5.7 mm				8920.311
Pressure ball for blowing air through channels				103.00
Tube with LUER-LOCK connector				886.00
Cleaning brush Ø 11 mm TL 360 mm				6.01
for connecting "Morcescope" to the 24 Fr and 26 Fr continuous irrigation sheaths				Product no.
Shark adapter for Morcescope 24/26 Fr				8675026
CI Double sheath system				
				
for sheath sizes		SL/WL	Color coding	Product no.
CI 22/24 Fr	Outer sheath for resectoscope 24 Fr	SL 189 mm	Green	8675424
	Inner sheath for resectoscope 22 Fr	SL 205 mm		8675322
Also:				
	Obturator for resectoscope 22 Fr	WL 232 mm	Green	8673022
	Viewing obturator for resectoscope 22 Fr			8673122
CI 24/26 Fr	Outer sheath for resectoscope 26 Fr	SL 189 mm	Yellow	8675426
	Inner sheath for resectoscope 24 Fr	SL 205 mm		8675324
Also:				
	Obturator for resectoscope 24 Fr	WL 233 mm	Yellow	8673024
	Viewing obturator for resectoscope 24 Fr	WL 232 mm		8673124
	Dilatations obturator f. resectoscope 24 Fr	WL 247 mm		8673224
Rotary morcellators and accessories				see UR090



MORCESCOPE, 0°

IN COMBINATION WITH **SHARK** OUTER SHEATHS
FOR TISSUE MORCELLATION



2 irrigation channels

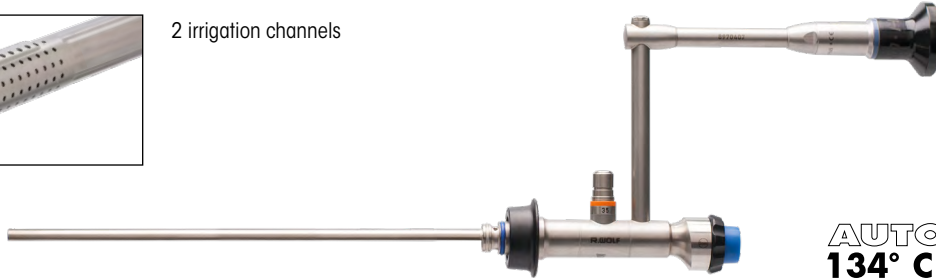

AUTOCLAVE
134° C / 273° F

PANOVIEW		WL	TL	Product no.
Morcescope 0° 24 Fr WL 199 mm Rigid, with parallel eyepiece, working channel for instruments up to 4.8 mm, irrigation via 24.5/26 Fr sheath and adapter, suction via morcellator		199 mm	393 mm	8970407
Autom. sealing element ID 5.7 mm				8920.311
Pressure ball for blowing air through channels				103.00
Tube with LUER-LOCK connector				886.00
Cleaning brush Ø 11 mm TL 360 mm				6.01
CI Double sheath system				
Distal end		Outer sheath		Inner sheath
for sheath sizes		SL/WL	Color coding	Product no.
CI 22/24 Fr	Outer sheath for resectoscope 24 Fr	SL 189 mm	Green	8675424
	Inner sheath for resectoscope 22 Fr	SL 205 mm		8675322
Also:				
	Obturator for resectoscope 22 Fr	WL 232 mm	Green	8673022
	Viewing obturator for resectoscope 22 Fr			8673122
CI 24/26 Fr	Outer sheath for resectoscope 26 Fr	SL 189 mm	Yellow	8675426
	Inner sheath for resectoscope 24 Fr	SL 205 mm		8675324
Also:				
	Obturator for resectoscope 24 Fr	WL 233 mm	Yellow	8673024
	Viewing obturator for resectoscope 24 Fr	WL 232 mm		8673124
	Dilatations obturator f. resectoscope 24 Fr	WL 247 mm		8673224
Rotary morcellators and accessories				see UR090

IX23 || Subject to modifications. Please note that some products may not be available in all countries. Please always take note of the information that is provided with the product. For more detailed information, please consult with your contact partner or directly with Richard Wolf GmbH.







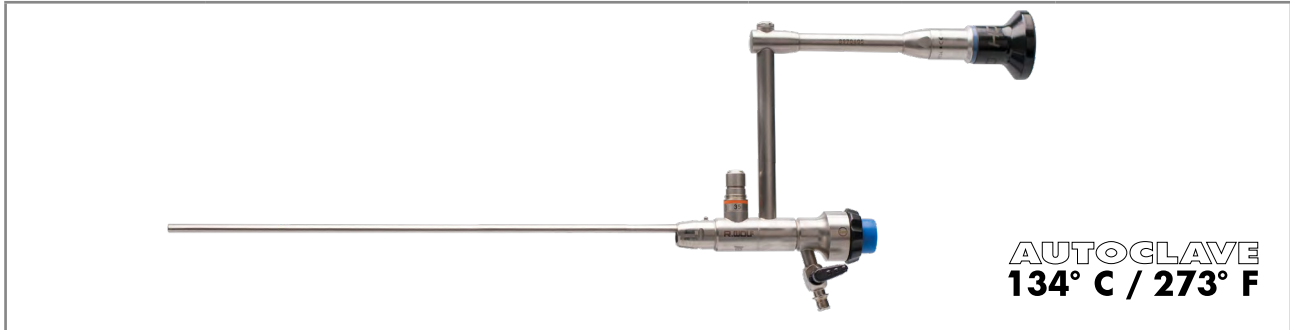

MORCESCOPE, 0°

IN COMBINATION WITH **E-LINE** OUTER SHEATHS
FOR TISSUE MORCELLATION







AUTOCLAVE
134° C / 273° F

PANOVIEW		WL	TL	Product no.
Morcescope 0° 24 Fr WL 224 mm Rigid, with parallel eyepiece, working channel for instruments up to 4.8 mm, irrigation via 24.5/26 Fr sheath and adapter, suction via morcellator		224 mm	386 mm	8970405
Autom. sealing element ID 5.7 mm				8920.311
Pressure ball for blowing air through channels				103.00
Tube with LUER-LOCK connector				886.00
Cleaning brush Ø 11 mm TL 360 mm				6.01
for connecting "Morcescope" to the 24 Fr and 26 Fr continuous irrigation sheaths			TL	Product no.
E-Line adapter for Morcescope 26 Fr			40 mm	8970.026
CI Double sheath system				
				
for sheath sizes		SL/WL	Color coding	Product no.
CI 22/24.5 Fr	Outer sheath for resectoscope 24.5 Fr	SL 191 mm	Green	8655.334
	Inner sheath for resectoscope 22 Fr	SL 203 mm		8655.344
Also:				
	Obturator for resectoscope 22 Fr	WL 230 mm	Green	8654.16
	Viewing obturator for resectoscope 22 Fr	WL 232 mm		8415.11
CI 24/26 Fr	Outer sheath for resectoscope 26 Fr	SL 191 mm	Yellow	8655.374
	Inner sheath for resectoscope 24 Fr	SL 204 mm		8655.384
Also:				
	Obturator for resectoscope 24 Fr	WL 230 mm	Yellow	8654.17
	Viewing obturator for resectoscope 24 Fr	WL 232 mm		8415.12
Rotary morcellators and accessories				see UR090

IX23 || Subject to modifications. Please note that some products may not be available in all countries. Please always take note of the information that is provided with the product. For more detailed information, please consult with your contact partner or directly with Richard Wolf GmbH.

ROTARY MORCELLATORS/ACCESSORIES FOR THE MORCESCOPE

	for single use (Pack = 3 PCS, in individual sterile packaging)	WL	Ø	Product no.
 	Rotary morcellator Ø 4.8 mm WL 335 mm	335 mm	4.8 mm	49700113
	Rotary morcellator Ø 4.8 mm WL 385 mm (for morcellator telescopes <i>from other manufacturers</i>)	385 mm	4.8 mm	49700103

	for multiple use	WL	Ø	Product no.
 	Rotary morcellator Ø 4.8 mm WL 350 mm	350 mm	4.8 mm	8970.011
	Rotary morcellator Ø 4.8 mm WL 385 mm (for morcellator telescopes <i>from other manufacturers</i>)	385 mm	4.8 mm	8970010

Recommended accessories	Product no.
Perforated basket for Morcescope with small parts sieve Holds: standard telescope, for machine reprocessing, sterilization (steam and low-temperature), storage, and transport,	Internal dimensions (W x H x D): 451 x 65 x 164 mm External dimensions (W x H x D): 467 x 75 x 172 mm 38012
Fiber light cable bndl consisting of: Fiber light cable (80663523), projector-side adapter (8095.07), and endoscope-side adapter (809509)	Ø 3.5 mm, 2.3 m long 806635231

TISSUE MORCELLATOR

FOR MORCELLATION AFTER LASER ENUCLEATION OF THE PROSTATE

"PIRANHA" MORCELLATION SYSTEM

1.20

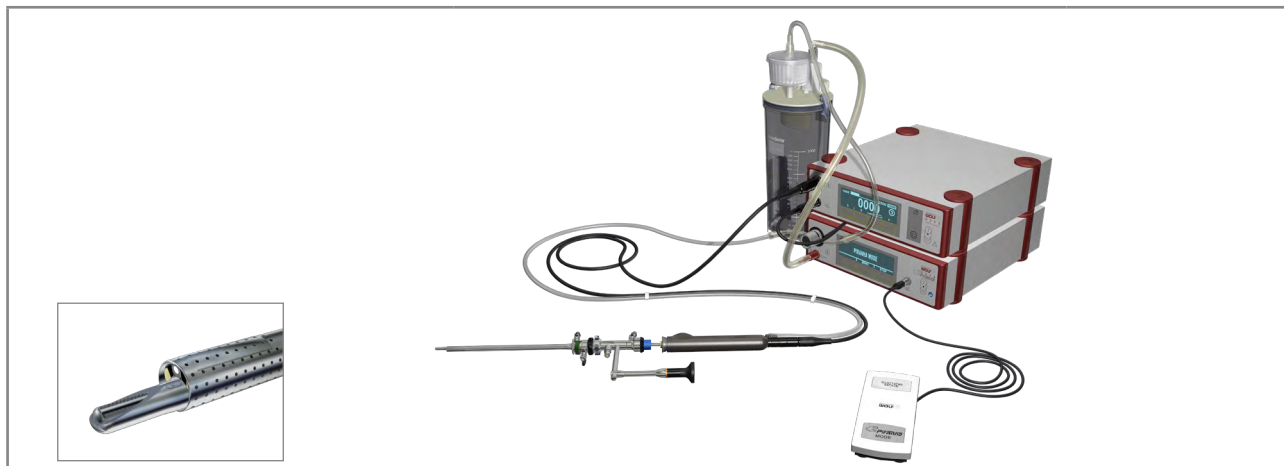

		Artikel-Nr.
Suction pump 2208	with LCD display, 100–240 V AC, 50/60 Hz	2208001
1-pedal footswitch		2030108
Bottle holder		64031.381
Sound absorber	(Pack= 3 PCS)	35100.115
RECTO PUMP connection tube		8170.6554
Overflow protection/bacteria filter	(Pack = 10 PCS)	2228.901
Secretion container, 2 l	2 liters, without cover	8170.6551
Cover	for secretion trap 8170.6551, reusable	8170.6552
optional: 3 L suction jar for RCS		077.0130
Power cable	Cable length 3 m	2440.03
Tube for suction	Single use (Pack = 10 PCS)	41702208
Collecting container	Disposable (Pack = 10 PCS)	2208120
Motor Control Unit 2303 for motor handpiece	50/60 Hz, 100–240 V AC	2303.001
also: Power cable	Cable length 3 m	2440.03
Motor handpiece max. 6,000 rpm	consisting of: Motor handpiece max. 6,000 rpm (8564.021), connection cable, WL 3 m (8564.851), sealing insert – open (15178145)	8564122
Irrigation adapter	for motor handpiece 8564.021, reusable	163951
Rotary morcellator Ø 4.8 mm WL 335 mm	(Pack = 3 PCS) in individual sterile packaging	49700113
Rotary morcellator Ø 4.8 mm WL 385 mm	(Pack = 3 PCS) in individual sterile packaging for morcellator telescopes <i>from other manufacturers</i>	49700103
Rotary morcellator Ø 4.8 mm WL 350 mm		8970.011
Rotary morcellator Ø 4.8 mm WL 385 mm		8970010

IX23 || Subject to modifications. Please note that some products may not be available in all countries. Please always take note of the information that is provided with the product. For more detailed information, please consult with your contact partner or directly with Richard Wolf GmbH.

MEGA Pulse 70⁺

70 W HOLMIUM:YAG LASER SYSTEM FOR STONE AND BPH THERAPY



"MEGA PULSE 70+" LASER

1.21

Product no.	
<p>MegaPulse 70⁺ Laser surgical device tower EU bndI consisting of: MegaPulse 70⁺ laser surgical device tower 70 W (2286007) 2x laser protection goggles (OBM003603) 1x key set (2286525) 1x door contact plug (2286520) 2x blast shield with mounting (OAM001523) 1x filling bottle with tube (IAM000088) 1x 2-pedal footswitch (2030232) 1x fiber-stripping forceps for stripping laser fibers, 0.3 to 1.0 mm (2286523) 1x fiber-stripping forceps for stripping laser fibers, 0.1 to 0.4 mm (2286527) 1x ceramic cutter with silicone pad (AGM000080) 1x accessories box for MegaPulse (KBM000103) 1x power cable TL 3 m (2286230)</p>	<p>22860070</p>

IX23 || Subject to modifications. Please note that some products may not be available in all countries. Please always take note of the information that is provided with the product. For more detailed information, please consult with your contact partner or directly with Richard Wolf GmbH.

MEGA Pulse 70⁺

TECHNICAL DATA

MEGA Pulse 70 ⁺		22860070
Device properties		
Display	12" touchscreen	
Power	70 watts	
Laser type	Holmium:YAG laser (Ho:YAG)	
Wavelength	2,100 nm (2.1 µm)	
Operating principle	Pulsed	
Energy	200–5,000 mJ	
Pulse duration	Adjustable (50–1,100 µs)	
Pilot beam	Green: 532 nm, < 5 mW, can be set to continuous or flashing	
Max. operating temperature	10–30 °C	
Storage temperature	Min. +5 °C, max. 40 °C	
Power supply		
Voltage	200–230 V, 50/60 Hz, < 32 A	
Frequency	3–60 Hz	
Dimensions and weights		
Dimensions (W x H x D)	595 x 1,200 x 1,074 mm	
Weight	200 kg	

MEGA Pulse⁷⁰⁺

LASER FIBERS

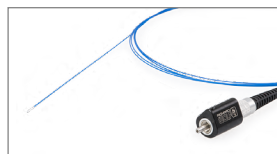

	Sterile (Pack= 1 PC)	Core diameter						Product no.
		200 μm	200 μm	272 μm	365 μm	550 μm	800 μm	
Single use	Power laser fiber Ø 200 μm, disposable	●						487502200
	Laser fiber Ø 200 μm, disposable		●					487501200
	Laser fiber Ø 272 μm, disposable			●				487501272
	Laser fiber Ø 365 μm, disposable				●			4875013650
	Laser fiber Ø 550 μm, disposable					●		487501550
	Laser fiber Ø 800 μm, disposable						●	487501800
	Laser fiber Ø 1,000 μm, disposable							●
Multiple use	Power laser fiber Ø 200 μm, reusable	●						87502200
	Laser fiber Ø 200 μm, reusable		●					87501200
	Laser fiber Ø 272 μm, reusable			●				87501272
	Laser fiber Ø 365 μm, reusable				●			875013650
	Laser fiber Ø 550 μm, reusable					●		87501550
	Laser fiber Ø 800 μm, reusable						●	87501800
	Laser fiber Ø 1,000 μm, reusable							●

IX23 || Subject to modifications. Please note that some products may not be available in all countries. Please always take note of the information that is provided with the product. For more detailed information, please consult with your contact partner or directly with Richard Wolf GmbH.

"MEGA PULSE 70+" LASER

1.21



MEGA Pulse⁷⁰⁺

ACCESSORIES

"MEGA PULSE 70+" LASER

1.21

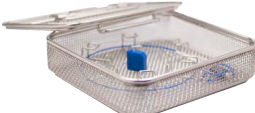
Accessories		Product no.	
Fiber-stripping forceps, autoclavable	for stripping laser fibers	Ø 200–272 µm	AGM000053
		Ø 365–400 µm	AGM000078
		Ø 550–600 µm	AGM000052
		Ø 800 µm	AGM000064
Fiber-stripping forceps	for stripping laser fibers	Ø 0.1–0.4 mm	2286527
		Ø 0.3–1.0 mm	2286523
Ceramic cutter with silicone pad		AGM000080	
Filling bottle with tube		IAM000088	
Laser protection goggles	(Also suitable for glasses-wearers)	OBM003603	
2-pedal footswitch		2030232	
Key set		2286525	
Door contact plug		2286520	
Blast shield with mounting		OAM001523	
Power cable TL 3 m		2286230	
Accessories box for MegaPulse		KBM000103	
Adapter cable	CEE coupling, 3-pin 32 A 6 h 230 V AC blue (on the device side) and CEE plug, 5-pin 32 A 6 h 400 V AC red (in-house)	100-201-0518	

Machine reprocessing		Product no.
 Perforated basket for laser fiber	Holds: Laser fiber, for machine reprocessing, sterilization (steam and low-temperature), storage, and transport; internal dimensions (W x H x D): 231 x 52 x 223 mm external dimensions (W x H x D): 248 x 72 x 239 mm	38001
Also:  Fixing ring Ø 34.6 mm	for holding instruments during machine reprocessing, sterilization (steam and low-temperature), storage, and transport, Ø 34.6 x 2.62 mm, Pack = 5 PCS	643301262

IX23 || Subject to modifications. Please note that some products may not be available in all countries. Please always take note of the information that is provided with the product. For more detailed information, please consult with your contact partner or directly with Richard Wolf GmbH.

Pulvis 60⁺

60 W THULIUM FIBER LASER (TFL)

FOR STONE THERAPY AND ENDOSCOPIC ENUCLEATION OF THE PROSTATE (EEP)

"PULVIS 60+" LASER

1.22



		Product no.
<p>Pulvis 60⁺ 60 W thulium fiber laser (TFL)</p>	<p>PFMS00006</p>	

IX23 || Subject to modifications. Please note that some products may not be available in all countries. Please always take note of the information that is provided with the product. For more detailed information, please consult with your contact partner or directly with Richard Wolf GmbH.

Pulvis 60⁺

60 W THULIUM FIBER LASER (TFL)

TECHNICAL DATA

Pulvis 60 ⁺		PFMS00006	
Device properties			
Display	Fold-out, rotatable touchscreen display (rotates 90° to the right and 180° to the left)		
Operating temperature	15–30 °C (at a room temperature between 25 °C and 30 °C, operation is guaranteed with a maximum output power of up to 40 W)		
Storage/transport temperature	Min. +5 °C/max. 40 °C		
Atmospheric pressure	800–1,060 hPa		
Operating humidity	30–85 %, non-condensing		
Max. noise level	< 70.0 dB		
Equipment			
Cooling method	Air cooling system		
Power supply			
Mains + frequency	100–240 V AC, 50/60 Hz		
Power consumption	1,000 VA		
Regulatory standards			
Classification according to the Medical Devices Directive 93/42/EEC	Class IIb		
Laser classification according to IEC/EN 60825-1:2014	Class 4		
Pilot beam classification according with IEC/EN 60825-1:2014	Class 3R		
Dimensions and weights			
Weight	100 kg		
Dimensions (W x H x D)	470 x 1,156 x 810 mm 470 x 940 x 810 mm – display closed		

Pulvis 60⁺

60 W THULIUM FIBER LASER (TFL)

TECHNICAL DATA

Pulvis 60 ⁺		PFMS00006
Laser source specifications		
Laser type	Thulium fiber-laser	
Wavelength	1,940 nm ± 20 nm	
Maximum output power	60 W (pulsed/CW)	
Pulse energy	0.02–6 J	
Operating mode	Pulsed/CW	
Pulse duration	50 µs – CW	
Frequency of recurrence	1–2,500 Hz	
Delivery system	Large selection of laser fibers (see next page) (sterile, disposable, and reusable)	
Pilot beam	Green 532 nm (adjustable) < 5 mW, class 3R	
Goggles	1940 D LB4	

Pulvis 60⁺

LASER FIBERS



Sterile (Pack= 10 PC)		Core diameter									Product no.
		150 µm	200 µm	272 µm	365 µm	500 µm	550 µm	600 µm	800 µm	1,000 µm	
Single use	Single use optical fiber 150 µm	●									OFJ001511
	Single use optical fiber 200 µm		●								OFJ002011
	Single use optical fiber 272 µm			●							OFJ702711
	Single use optical fiber ball tip 272 µm			●							OFJ302711
	Single use optical fiber 365 µm				●						OFJ703611
	Single use optical fiber 550 µm						●				OFJ005511
	Single use optical fiber lateral 600 µm							●			OFJ506011
	Single use optical fiber 800 µm								●		OFJ008011
	Single use optical fiber 1,000 µm									●	OFJ009911
Multiple use	Reusable 10x optical fiber 200 µm		●								OFJ002013
	Reusable 10x optical fiber 272 µm			●							OFJ702713
	Reusable 10x optical fiber 365 µm				●						OFJ703613
	Reusable 10x optical fiber 500 µm					●					OFJ005513
	Reusable 10x optical fiber 800 µm								●		OFJ008013
	Reusable 10x optical fiber 1,000 µm									●	OFJ009913

Pulvis 60⁺

ACCESSORIES

Accessories	Product no.
Interlock Conn. Medical Devices Binder	EAM000045.00
Key	MBQ000190.00
Power cord-5m-spina Shuko 16A EUR	EAM001440.00
Fiberstripper optical fibers Ø300-1000 µm	OBM001079.00
Fiberstripper optical fibers Ø100-400 µm	OBM001080.00
Case salsa 1650 no brand accessories	KBM000103.01
Ceramic fiber cutter with slipcase	AGM000080.00
Goggle protection f18.P1d09.1003	OBM003778.00
Optical blast shield for ffl ext-access	OAM002112.00

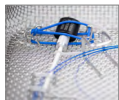
Machine reprocessing	Product no.
 <p>Perforated basket for laser fiber</p>	<p>Holds: Laser fiber, for machine reprocessing, sterilization (steam and low-temperature), storage, and transport; internal dimensions (W x H x D): 231 x 52 x 223 mm external dimensions (W x H x D): 248 x 72 x 239 mm</p> <p>38001</p>
<p>Also:</p>  <p>Fixing ring Ø 34.6 mm</p>	<p>for holding instruments during machine reprocessing, sterilization (steam and low-temperature), storage, and transport, Ø 34.6 x 2.62 mm, Pack = 5 PCS</p> <p>643301262</p>

HF GENERATOR 2260

core



HF GENERATOR 2260

1.23

		Product no.
HF surgical generator 400 kHz	for the connection of monopolar and bipolar accessories, international version (BOWA, KLS Martin, Olympus, Karl Storz, Valleylab)	2260001
HF surgical generator 400 kHz	for the connection of monopolar and bipolar accessories, E version (Erbe)	2260002

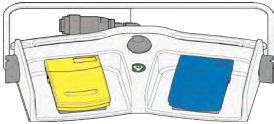
Accessories required	Cable length	Product no.
Footswitch, 2 pedals L 5 m with fixed connection cable, reusable 		2260021
Neutral electrode for use with high-frequency surgical device, foil bag with 5 neutral electrodes (Pack = 50 PCS)		1280H
Mono HF neutral electrode cable, L 4.5 m	4.5 m	2260031
Power cable	3.0 m	2440.03
Bipo HF connection cable L 3 m	3.0 m	8108233
Bipo HF connection cable L 5 m	5.0 m	8108253

HF GENERATOR 2260







TECHNICAL DATA

HF surgical generator 400 kHz		2260001/2260002
Device properties		
Type of controls on housing front		Touch panel
Output power	Max. cutting power	400 W
	Max. coagulation power	350 W
LF and HF leakage currents		Acc. to DIN EN 60601-1 and DIN EN 60601-2-2
Signal level		HF indicator 55 dB(A); adjustable 45–60 dB(A) Alarm 65 dB(A)
Operating conditions		+10 °C to +40 °C, 30 % to 75 % rel. humidity, 700 hPa to 1,060 hPa atmospheric pressure
Storage and transport conditions		-20 °C to +60 °C, 10 % to 90 % rel humidity, 700 hPa to 1,060 hPa atmospheric pressure
Power supply		
Mains + frequency		100–240 V AC, 50/60 Hz
Power consumption	without HF output	45 VA
	at max. output power	650 VA
Current consumption		Max. 6.3 A
Fuse		T 6.3 AH 250 V
Regulatory standards		
Protection class to EN/IEC 60601-1 (UL 2601-1/CSA C22.2 No.601.1 – for USA)		I
Electromagnetic compatibility (EMC)		EN/IEC 60601-1-2
Medical Devices Directive 93/42/EEC		Class IIb
Degree of protection against the ingress of liquids (DIN EN/IEC 60529)		IP X0
Degree of protection against the ingress of solids		IP 2X
Duty factor (duty cycle DC)		Intermittent INT 10 s/30 s corresponding to 25 % DC
Protection against electric shock		Type CF applied part, defibrillator-proof
Degree of protection in the presence of flammable mixtures		Device is not protected against explosions (do not operate this device in explosive atmospheres)
Dimensions and weights		
Weight		10.2 kg (22.4 lbs)
Dimensions (W x H x D)		300 x 159 x 419 mm

HF CONNECTION CABLE MONO 815XXX

HF CONNECTION CABLE

1.24

Instrument connector	Device connector		Product no.
WOLF Resectoscopes 	 <p>ERBE (ACC/ICC/IO)/BOWA (EU) R. Wolf HF surgical generator 400 kHz 2260002</p>	HF connection cable mono L 3 m	815.032
		HF connection cable mono L 5 m	815.052
	 <p>ERBE (T series)</p>	HF connection cable mono L 3 m	815.132
		HF connection cable mono L 5 m	815.152
HF electrodes, monopolar 	 <p>Martin (M-version)/Berchtold/ Aesculap</p>	HF connection cable mono L 3 m	815.031
		HF connection cable mono L 5 m	815.051
	 <p>Bovie/Valleylab/Erbe (Int.)/ BOWA (Int.) R. Wolf HF surgical generator 400 kHz 2260001</p>	HF connection cable mono L 3 m	815.033
		HF connection cable mono L 5 m	815.053
	 <p>BOWA (Int./EU) Eschmann and other devices with 4 mm plugs R. Wolf HF surgical generator 400 kHz 2260001</p>	HF connection cable mono L 3 m	815.034
		HF connection cable mono L 5 m	815.054

IX23 || Subject to modifications. Please note that some products may not be available in all countries. Please always take note of the information that is provided with the product. For more detailed information, please consult with your contact partner or directly with Richard Wolf GmbH.

HF CONNECTION CABLE MONO 8106xxx









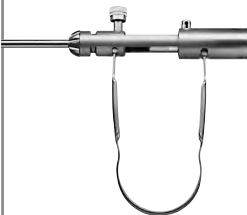

HF CONNECTION CABLE

1.24

Instrument connector	Device connector		Product no.
WOLF Instruments/surgical generator 		HF connection cable mono L 3 m	8106.032
	ERBE (ACC/ICC/IO)/BOWA (EU) R. Wolf HF surgical generator 400 kHz 2260002	HF connection cable mono L 5 m	8106.052
		HF connection cable mono L 3 m	8106.132
	ERBE (T series)	HF connection cable mono L 5 m	8106.152
		HF connection cable mono L 3 m	8106.031
	Martin (M-version)/Berchtold/ Aesculap	HF connection cable mono L 5 m	8106.051
HF electrodes, monopolar 		HF connection cable mono L 3 m	8106.033
	Bovie/Valleylab/Erbe (Int.)/ BOWA (Int.) R. Wolf HF surgical generator 400 kHz 2260001	HF connection cable mono L 5 m	8106.053
		HF connection cable mono L 3 m	8106.034
	BOWA (Int./EU) Eschmann and other devices with 4 mm plugs R. Wolf HF surgical generator 400 kHz 2260001/2260002	HF connection cable mono L 5 m	8106.054

IX23 || Subject to modifications. Please note that some products may not be available in all countries. Please always take note of the information that is provided with the product. For more detailed information, please consult with your contact partner or directly with Richard Wolf GmbH.

HF CONNECTION CABLE BIPO 8108XXX







Instrument connector	Device connector		Product no.	
WOLF Bipolar forceps 	 ERBE (ACC/ICC/T)/BOWA (EU) R. Wolf HF surgical generator 400 kHz 2260001/2260002	HF connection cable bipo; L 3 m	8108.032	
		HF connection cable bipo; L 5 m	8108.052	
	 International / 2-pin Valleylab R. Wolf HF surgical generator 400 kHz 2260001/2260002	HF connection cable bipo; L 3 m	8108.033	
		HF connection cable bipo; L 5 m	8108.053	
	 WOLF/Martin (M-version)/ Berchtold/Aesculap	HF connection cable bipo; L 3 m	8108.031	
		HF connection cable bipo; L 5 m	8108.051	
	 EMC Dolley	HF connection cable bipo; L 3 m	8108035	
	Bipolar tweezers connection 	 ERBE (ACC/ICC/T)/BOWA (EU) R. Wolf HF surgical generator 400 kHz 2260001/2260002	HF connection cable bipo; L 3 m	8108.132
			HF connection cable bipo; L 5 m	8108.152
		 International / 2-pin Valleylab R. Wolf HF surgical generator 400 kHz 2260001/2260002	HF connection cable bipo; L 3 m	8108.133
HF connection cable bipo; L 5 m			8108.153	
 Martin (M-version)/Berchtold/ Aesculap		HF connection cable bipo; L 3 m	8108.131	
		HF connection cable bipo; L 5 m	8108.151	
 EMC Dolley		HF connection cable bipo; L 3 m	8108135	

IX23 || Subject to modifications. Please note that some products may not be available in all countries. Please always take note of the information that is provided with the product. For more detailed information, please consult with your contact partner or directly with Richard Wolf GmbH.

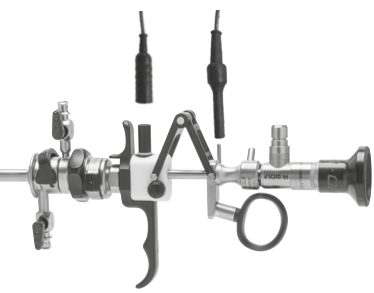
HF CONNECTION CABLE BIPO FOR RESECTION IN SALINE SOLUTION

HF CONNECTION CABLE

1.24

Instrument connector	Device connector		Product no.
<p>WOLF S(a)line resectoscopes</p> 	 Erbe VIO 300D	<p>Bipolar cable; TUR/TCR; WOLF MF plug; L 4 m</p>	<p>20196-119</p>
	 Erbe VIO 3	<p>Bipolar cable; MF-U MF plug; L 4.5 m</p>	<p>21196-119</p>
	 KLS Martin	<p>HF connection cable bipo; L 3 m</p>	<p>8108.231</p>
	 KLS Martin	<p>HF connection cable bipo; L 5 m</p>	<p>8108.251</p>
	 R. Wolf HF surgical generator 400 kHz 2260001/2260002	<p>HF connection cable bipo; L 3 m</p>	<p>8108233</p>
	 R. Wolf HF surgical generator 400 kHz 2260001/2260002	<p>HF connection cable bipo; L 5 m</p>	<p>8108253</p>

IX23 || Subject to modifications. Please note that some products may not be available in all countries. Please always take note of the information that is provided with the product. For more detailed information, please consult with your contact partner or directly with Richard Wolf GmbH.

FLUID CONTROL 2225

SUCTION IRRIGATION PUMP



		Product no.
FLUID CONTROL 2225 Irrigation pump for HYS/URO/LAP bndI consisting of: Irrigation pump for HYS/URO/LAP (2225001) and power cable 3 m long (2440.03)		22250011
Also:		
Balancing module for hysteroscopy and endourology, fluid management for fluid balancing in combination with FLUID CONTROL 2225, mobile stand with integrated weighing cells and space for up to 4 irrigation fluid bags		2225023

Accessories		Product no.
Footswitch	Only for use in urology and within the indication TUR/enucleation, possibility of short-term increase in pressure if visibility is poor (Flush function)	2204901

Cable accessories		Product no.
Patch cable, RJ45 SFTP, 0.5 m	Cable length 0.5 m	72325378
Patch cable, RJ45 HRS TM11, 1.0 m	Cable length 1.0 m	72325429
Patch cable, RJ45 S/FTP CAT.6 10 m	Cable length 10 m	72325434
Plastic caps for network socket	(Pack = 8 PCS)	5592105
Power cable	Cable length 3 m	2440.03

FLUID CONTROL 2225

1.25

FLUID CONTROL 2225

SUCTION IRRIGATION TUBE SETS

Irrigation			Product no.
Accessories – reusable	Tube set with piercing spike	with Luer-Lock connection, autoclavable, incl. 10 spare membranes, reusable for 20 reprocessing cycles	8171223
Accessories – disposable	Irrigation tube set with piercing spike, L 3 m	(PACK= 10 PCS), with Luer-Lock connection, sterile, disposable product	4171223
	Tube set with CARE-LOCK, L 3 m	(PACK= 10 PCS), sterile, disposable product	4171224
	Suction irrigation tube set	(PACK= 10 PCS), with piercing spike, sterile disposable product, PVC	4171225

Suction			Product no.
Accessories – reusable	Tube set for vacuum, incl. filter	with integrated hygiene filter, PACK= 10 PCS, service life: 30 days (connected to irrigation pump)	2206207
	Irrigation tube	L 1.2 m, with Luer-Lock, for suction irrigation handle 8385.901 and tube set 8171223 or 8170.223	817123
	Suction tube L 3 m	for suction irrigation handle 8385.901	8171402
	Secretion container, 2 l	2 liters, without cover	8170.6551
	Cover	for secretion trap 8170.6551, reusable	8170.6552
Accessories – disposable	Secretion container, 2.5 l	2.5 liters	41706566
	Secretion container bndl consisting of:	Secretion container 2.5 l (41706566) and secretion bag (PACK= 90 PCS) (41706564)	4170657
	Tube set for suction (2 connections)	sterile, disposable product, (PACK= 10 PCS) for connecting instruments to collecting container	T0503-01
	Angled 90° plug-in coupling	(PACK= 10 PCS) For connecting vacuum tube 2206207 to disposable container systems	0771019

TECHNICAL DATA

FLUID CONTROL 2225

FLUID CONTROL 2225		2225001
Device properties		
Operating conditions		+10 °C to +40 °C, 30 % to 75 % rel. humidity, 70 to 106 kPa atmospheric pressure 3,000 m max. altitude above sea level
Storage and transport conditions		-20 °C to +60 °C, 10 % to 90 % rel. humidity, 70 to 106 kPa atmospheric pressure
Power supply		
Mains + frequency		100–240 V AC, 50/60 Hz
Power consumption	100 V/60 Hz	110 VA
	240 V/50 Hz	120 VA
Current consumption	100 V/60 Hz	1.10 A
	240 V/50 Hz	0.50 A
Fuse		T 3.15 AH, 250 V
Regulatory standards		
Protection class (I, II)		I
Electromagnetic compatibility (EMC)		EN 60601-1/IEC 60601-1 EN 60601-1-2/IEC 60601-1-2
Medical Devices Directive 93/42/EEC		Class IIb
Housing protection rating (IP code)		IP 21
Protection against electric shock		Type BF applied part
Degree of protection in the presence of flammable mixtures		Device is not protected against explosions (do not operate this device in explosive atmospheres)
Maximum suction vacuum		-60 kPa
Dimensions and weights		
Weight		8.8 kg
Dimensions (W x H x D)		300 mm x 157 mm x 436 mm

Relevant application parameters	
Nominal flow range	Hysteroscopy: 800 ml/min (max. flow, not adjustable) Endourology: 10–800 ml/min (max. flow) Laparoscopy: 0.1–1.8 l/min (max. flow)
Suction power	Max. 2 l/min
Starting nominal pressure range	Hysteroscopy: 15–200 mmHg Endourology: 15–90 mmHg/20–120 cmH2O Laparoscopy: 300 mmHg (not adjustable)
Pressure	0–300 mmHg
Deficit	-9,990 to +9,990 ml/0 to 99.9 l

TECHNICAL DATA

FLUID CONTROL 2225

Balancing module 2225023	
Device properties	
Operating conditions	+10 °C to +40 °C, 30 % to 75 % rel. humidity, 70 to 106 kPa atmospheric pressure 3,000 m max. altitude above sea level
Storage and transport conditions	-20 °C to +60 °C, 10 % to 90 % rel. humidity, 70 to 106 kPa atmospheric pressure
Regulatory standards	
Electromagnetic compatibility (EMC)	EN 60601-1/IEC 60601-1 EN 60601-1-2/IEC 60601-1-2
Housing protection rating (IP code)	IP 21
Maximum load of container scale	16 kg/4 containers of 3 l each
Maximum load of bag scale	23 kg/4 bags of 5 l each
Dimensions and weights	
Weight	15.4 kg
Dimensions (W x H x D)	618 mm x 1,064 mm x 618 mm

Footswitch 2204901	
Power supply	
Power supply connection	Max. 24 V
Power consumption	Max. 0.1 A
Regulatory standards	
Electromagnetic compatibility (EMC)	EN 60601-1/IEC 60601-1
Housing protection rating (IP code)	IP X8
Plug	7-pin circular connector
Cable length	4.5 m
Dimensions and weights	
Weight	300 g
Dimensions (W x H x D)	66 mm x 27 mm x 91 mm

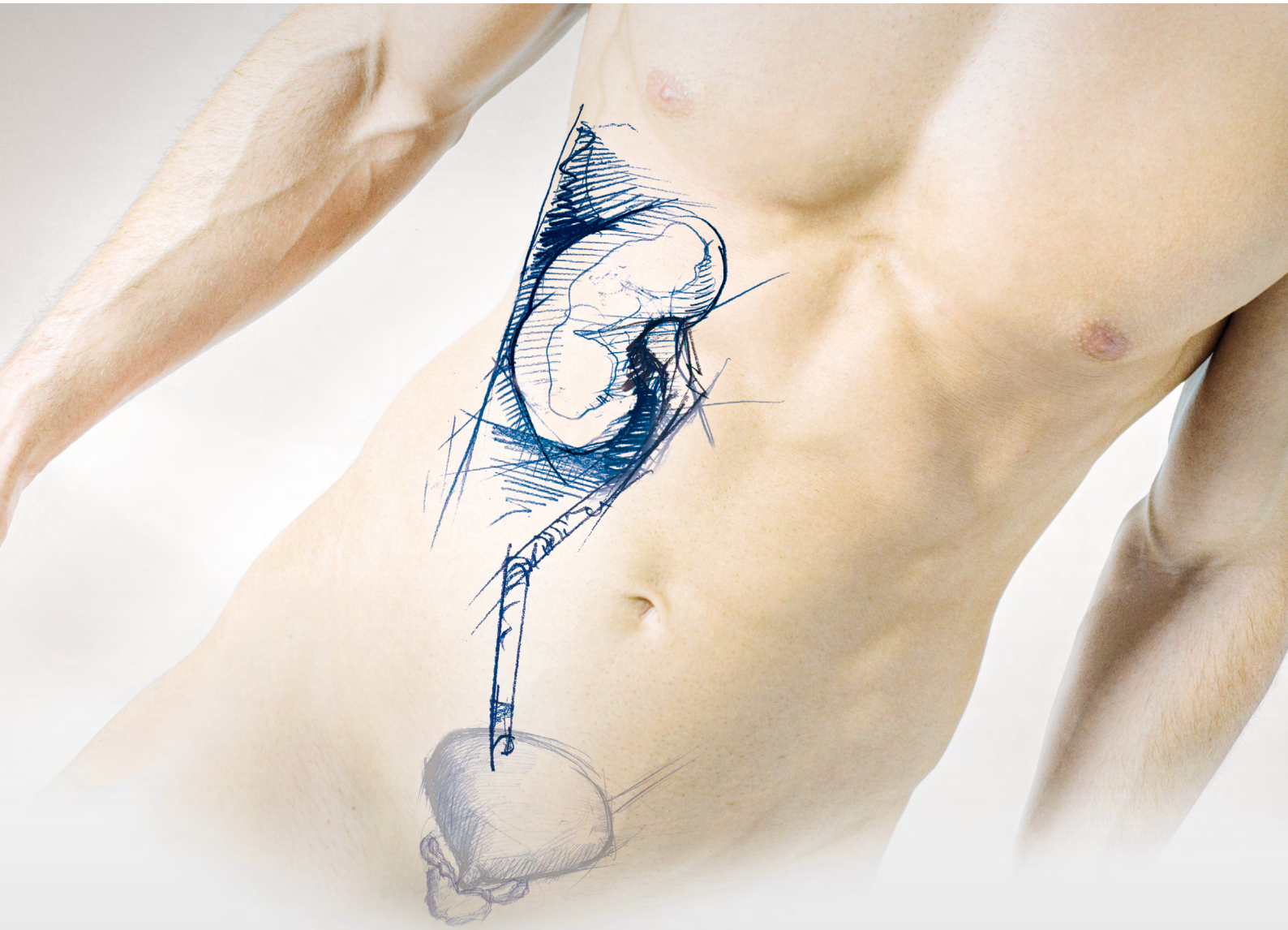

UPPER URINARY TRACT

UPPER URINARY TRACT

URETERORENOSCOPY

2.1 "E-LINE" URETERORENOSCOPE / FIBER URETERORENOSCOPES / CONTINUOUS IRRIGATION URETERORENOSCOPES

2.2 FLEXIBLE FIBER URS 270° – THE VIPER

2.3 FLEXIBLE 2-CHANNEL CONTINUOUS IRRIGATION LASER URS – THE COBRA

2.4 FLEXIBLE 1-CHANNEL SENSOR URETERORENOSCOPES - BOA vision / BOA vision EF

2.5 FLEXIBLE 2-CHANNEL SENSOR URETERORENOSCOPES – COBRA vision / COBRA vision EF

2.6 DISPOSABLE SENSOR URETERORENOSCOPE – RIWO D-URS

NEPHROSCOPY

2.7 DILATORS FOR PERCUTANEOUS UNIVERSAL NEPHROSCOPES

2.8 MINI NEPHROSCOPE BY LAHME

2.9 PERCUTANEOUS UNIVERSAL NEPHROSCOPE, "DRESDEN MODEL"

2.10 PERCUTANEOUS UNIVERSAL NEPHROSCOPES

2.11 FLEXIBLE FIBER NEPHROSCOPE

LASER ENERGY SOURCES

2.12 "MEGA PULSE 70+" HOLMIUM:YAG LASER (Ho:YAG)

2.13 "PULVIS 60+" THULIUM FIBER LASER (TFL)

SUCTION IRRIGATION PUMP

2.14 FLUID CONTROL 2225

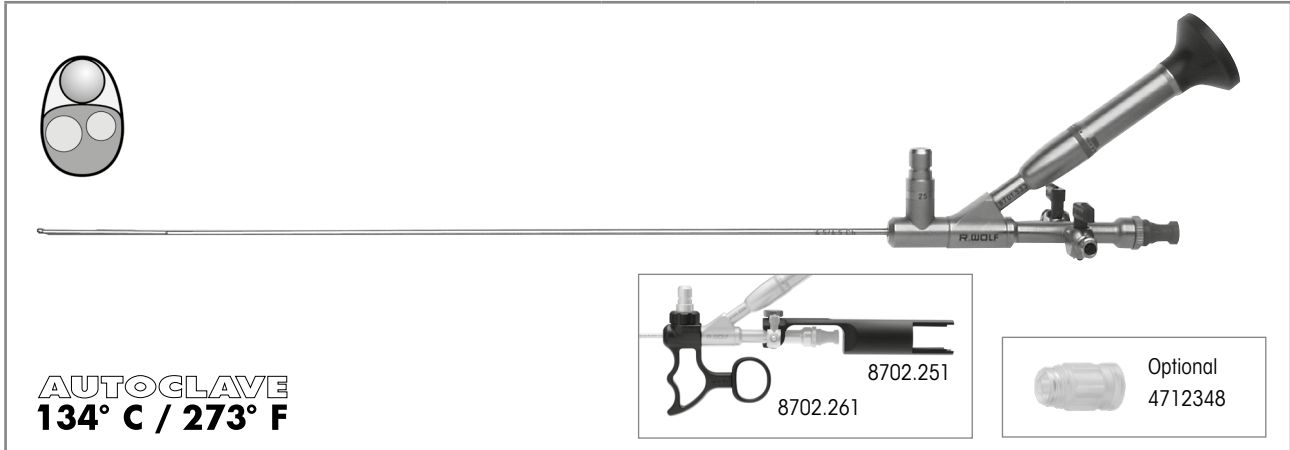

E-line

ULTRA-THIN FIBER URETERORENOSCOPE
WITH LATERAL EYEPIECE



AUTOCLAVE
134° C / 273° F

	WL	TL	Direction of view	Endoscope tip/Sheath tube	Working channel	Product no.
Ureterorenoscope 5° 4.5/6.5 Fr WL 430 mm Atraumatically shaped tip	430 mm	555 mm	5°	4.5/6.5 Fr	3 Fr	8701.534

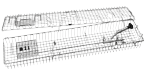
Recommended accessories		Product no.
	Flex. grasping forceps 3 Fr WL 530 mm	828.605
	Flex. biopsy forceps 3 Fr WL 530 mm	829.603
Handle for E-Line ureterorenoscopes		8702.261
Guide element for ureterorenoscope for LITHOCLAST handpieces		8702.251
for inserting auxiliary instruments of 1–6 Fr: universal sealing valve 1–6 Fr , sterile (Pack = 5 PCS)		4712348
Membrane holder standard		15256.393
Membrane holder with Luer		15256.456
Seal Ø 7.5 mm (Pack = 10 pcs)		89.101
Perforated basket, upper urinary tract 1 with small part basket	 Internal dimensions (W x H x D): 619 x 65 x 124 mm External dimensions (W x H x D): 35 x 75 x 132 mm	38003
Marking pen , black		38201.948
Fiber light cable bndl consisting of: Fiber light cable (80662523), projector-side adapter (8095.07), and endoscope-side adapter (809509)	Ø 2.5 mm, 2.3 m long	806625231
Auxiliary instruments		see URO119

IX23 || Subject to modifications. Please note that some products may not be available in all countries. Please always take note of the information that is provided with the product. For more detailed information, please consult with your contact partner or directly with Richard Wolf GmbH.

E-line

FIBER URETERORENOSCOPE

WITH STRAIGHT EYEPIECE



AUTOCCLAVE
134° C / 273° F

	WL	TL	Direction of view	Endoscope tip/Sheath tube	Working channel	Product no.
Ureterorenoscope 5° 6/7.5 Fr WL 430 mm Atraumatically shaped tip	430 mm	558 mm	5°	6/7.5 Fr	1 x 4 Fr or 2 x 2.2 Fr	8702.514
Ureterorenoscope 12° 8/9.8 Fr WL 430 mm Atraumatically shaped tip	430 mm	558 mm	12°	8/9.8 Fr	1 x 5 Fr or 2 x 3 Fr	8703.514

Recommended accessories		Product no.
Handle for E-Line ureterorenoscopes		8702.261
for inserting auxiliary instruments of 1–6 Fr: universal sealing valve 1–6 Fr, sterile (Pack = 5 PCS)		4712348
Perforated basket, upper urinary tract 1 with small part basket	 Internal dimensions (W x H x D): 619 x 65 x 124 mm External dimensions (W x H x D): 635 x 75 x 132 mm	38003
Marking pen, black		38201.948
Fiber light cable bndl consisting of: Fiber light cable (80662523), projector-side adapter (8095.07), and endoscope-side adapter (809509)		Ø 2.5 mm, 2.3 m long 806625231
Auxiliary instruments		see URO119

E-line

**FIBER URETERORENOSCOPE
WITH LATERALLY OFFSET EYEPIECE**

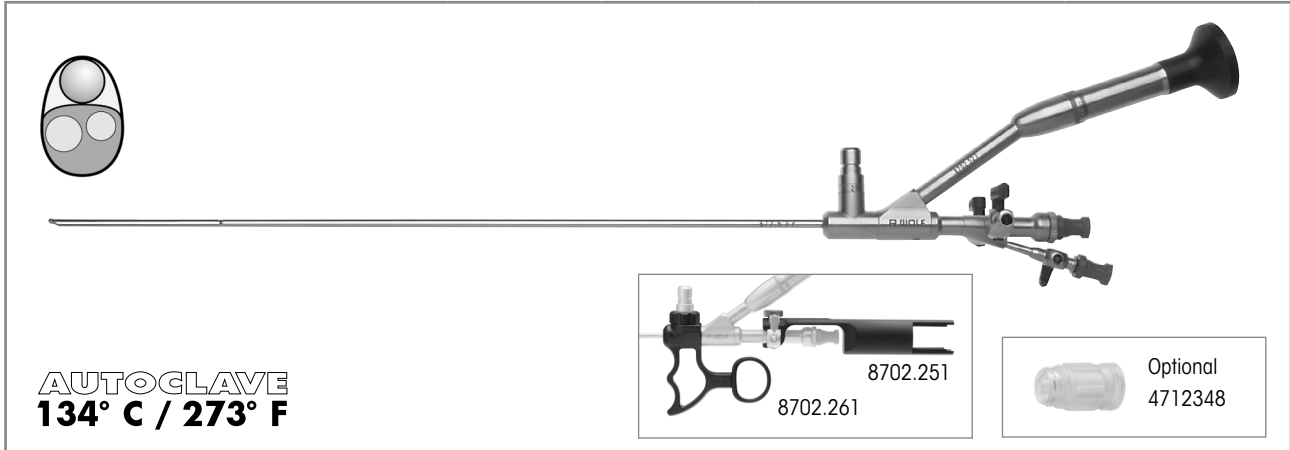

**AUTOCLAVE
134° C / 273° F**

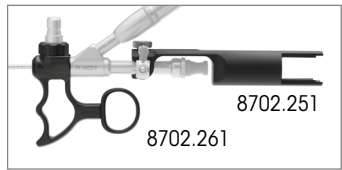

	WL	TL	Direction of view	Endoscope tip/Sheath tube	Working channel	Product no.
Ureterorenoscope 5° 6/7.5 Fr WL 430 mm Atraumatically shaped tip	430 mm	599 mm	5°	6/7.5 Fr	1 x 4 or (2 x 2.2) Fr	8702.524
Ureterorenoscope 12° 8/9.8 Fr WL 430 mm Atraumatically shaped tip	430 mm	599 mm	12°	8/9 Fr	1 x 5 or (2 x 3) Fr	8703.524
Ureterorenoscope 12° 8.5/11.5 Fr WL 430 mm Atraumatically shaped tip	430 mm	599 mm	12°	8.5/11.5 Fr	1 x 6 or (2 x 4) Fr	8704.524

Recommended accessories		Product no.
Handle for E-Line ureterorenoscopes		8702.261
Guide element for ureterorenoscope for LITHOCLAST handpieces		8702.251
for inserting auxiliary instruments of 1–6 Fr: universal sealing valve 1–6 Fr, sterile (Pack = 5 PCS)		4712348
Membrane holder standard		15256.393
Membrane holder with Luer connection		15256.456
Seal Ø 7.5 mm (Pack = 10 pcs)		89.101
Perforated basket, upper urinary tract 1 with small part basket		Internal dimensions (W x H x D): 619 x 65 x 124 mm External dimensions (W x H x D): 635 x 75 x 132 mm 38003
Marking pen, black		38201.948
Fiber light cable bndl consisting of: Fiber light cable (80662523), projector-side adapter (8095.07), and endoscope-side adapter (809509)		Ø 2.5 mm, 2.3 m long 806625231
Auxiliary instruments		see URO119

IX23 || Subject to modifications. Please note that some products may not be available in all countries. Please always take note of the information that is provided with the product. For more detailed information, please consult with your contact partner or directly with Richard Wolf GmbH.

E-line

FIBER URETERORENOSCOPE
WITH LATERAL EYEPIECE

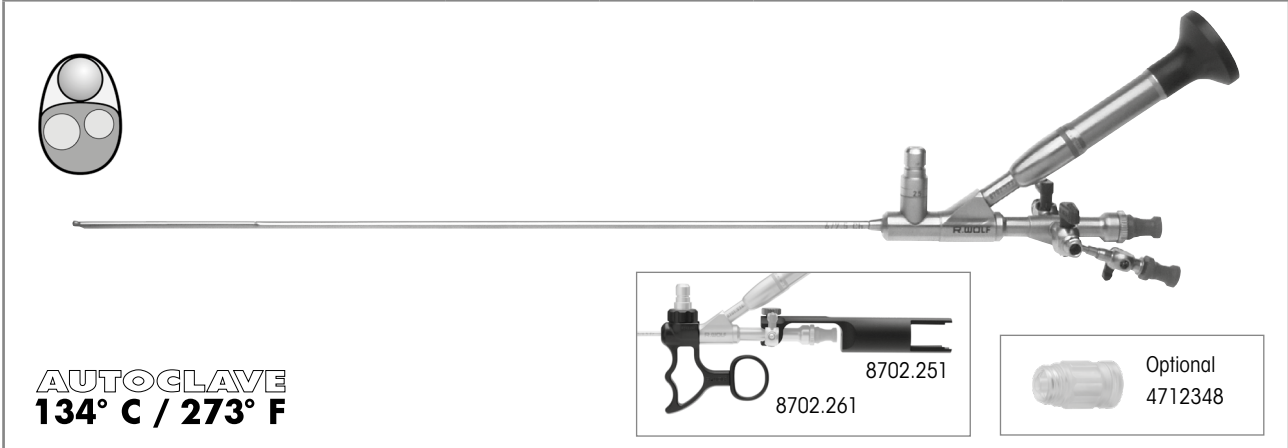

AUTOCLAVE
134° C / 273° F

	WL	TL	Direction of view	Endoscope tip / Sheath tube	Working channel	Product no.
Ureterorenoscope 5° 6/7.5 Fr WL 430 mm Atraumatically shaped tip	430 mm	563 mm	5°	6/7.5 Fr	1 x 4 Fr or 2 x 2.2 Fr	8702.534
Ureterorenoscope 12° 8/9.8 Fr WL 430 mm Atraumatically shaped tip	430 mm	563 mm	12°	8/9.8 Fr	1 x 5 Fr or 2 x 3 Fr	8703.534

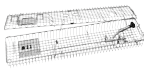
Recommended accessories		Product no.
Handle for E-Line ureterorenoscopes		8702.261
Guide element for ureterorenoscope for LITHOCLAST handpieces		8702.251
for inserting auxiliary instruments of 1–6 Fr: universal sealing valve 1–6 Fr, sterile (Pack = 5 PCS)		4712348
Membrane holder standard		15256.393
Membrane holder with Luer		15256.456
Seal Ø 7.5 mm (Pack = 10 pcs)		89.101
Perforated basket, upper urinary tract 1 with small part basket		Internal dimensions (W x H x D): 619 x 65 x 124 mm External dimensions (W x H x D): 635 x 75 x 132 mm
Marking pen, black		38201.948
Fiber light cable bndl consisting of: Fiber light cable (80662523), projector-side adapter (8095.07), and endoscope-side adapter (809509)		Ø 2.5 mm, 2.3 m long 806625231
Auxiliary instruments		see URO119

E-line

CONTINUOUS IRRIGATION URETERORENOSCOPE
WITH STRAIGHT EYEPIECE

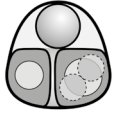

AUTOCLAVE
134° C / 273° F



	WL	TL	Direction of view	Endoscope tip / Sheath tube	Working channel	Product no.
Ureterorenoscope 5° 6.5/8.5 Fr WL 430 mm Atraumatically shaped tip	430 mm	572 mm	5°	6.5 / 8.5 Fr	Working channel 1: 1 x 4 (2 x 2.2) Fr Working channel 2: 2.4 Fr	8708.518

Recommended accessories		Product no.
Handle for E-Line ureterorenoscopes		8702.261
for inserting auxiliary instruments of 1–6 Fr: universal sealing valve 1–6 Fr, sterile (Pack = 5 PCS)		4712348
Perforated basket, upper urinary tract 1 with small part basket	 Internal dimensions (W x H x D): 619 x 65 x 124 mm External dimensions (W x H x D): 635 x 75 x 132 mm	38003
Marking pen, black		38201.948
Fiber light cable bndl consisting of: Fiber light cable (80662523), projector-side adapter (8095.07), and endoscope-side adapter (809509)		Ø 2.5 mm, 2.3 m long 806625231
Auxiliary instruments		see URO119

E-line

CONTINUOUS IRRIGATION URETERORENOSCOPE

WITH LATERAL EYEPIECE

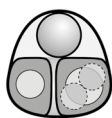

AUTOCLAVE
134° C / 273° F

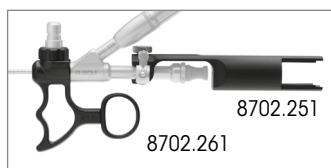

	WL	TL	Direction of view	Endoscope tip/Sheath tube	Working channel	Product no.
Ureterorenoscope 5° 6.5/8.5 Fr WL 430 mm Atraumatically shaped tip	430 mm	563 mm	5°	6.5/8.5 Fr	1 x 4.2 Fr and 2 x 2.4 Fr	8708.534
Ureterorenoscope 12° 8/9.8 Fr WL 430 mm Atraumatically shaped tip	430 mm	563 mm	12°	8/9.8 Fr	1 x 5 or (2 x 3) Fr	8703.534







Recommended accessories		Product no.
Handle for E-Line ureterorenoscopes		8702.261
Guide element for ureterorenoscope for LITHOCLAST handpieces		8702.251
for inserting auxiliary instruments of 1–6 Fr: universal sealing valve 1–6 Fr , sterile (Pack = 5 PCS)		4712348
Membrane holder standard		15256.393
Membrane holder with Luer connection		15256.456
Seal Ø 7.5 mm (Pack = 10 pcs)		89.101
Perforated basket, upper urinary tract 1 with small part basket		Internal dimensions (W x H x D): 619 x 65 x 124 mm External dimensions (W x H x D): 635 x 75 x 132 mm 38003
Marking pen, black		38201.948
Fiber light cable bndl consisting of: Fiber light cable (80662523), projector-side adapter (8095.07), and endoscope-side adapter (809509)		Ø 2.5 mm, 2.3 m long 806625231
Auxiliary instruments		see URO119

IX23 | Subject to modifications. Please note that some products may not be available in all countries. Please always take note of the information that is provided with the product. For more detailed information, please consult with your contact partner or directly with Richard Wolf GmbH.

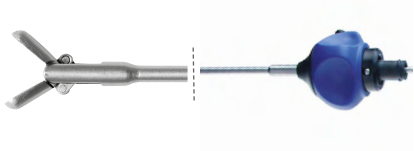
FORCEPS AND SCISSORS

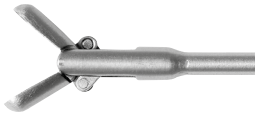
SMALL MODULAR SYSTEM **HySafe**

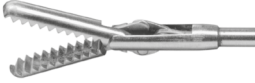
360° ROTATABL, CAN BE FLUSHED THROUGH, EASY-CLICK

Grasping forceps jaw insert with sheath				Handle with overload protection	Complete instrument
					<ul style="list-style-type: none"> Jaw section Handle
	Product no.	Fr	WL	8083.001	Product no.
Biopsy forceps bndl 	8952.6008	5	550 mm	•	8952.6002
Grasping forceps bndl with mouse tooth 	8952.6118	4	550 mm	•	8952.6112
	8959.6218	5	425 mm	•	8959.6212
	8952.6218	5	550 mm	•	8952.6212
Grasping forceps bndl with pike-mouth jaws, long 	8959.6808	5	425 mm	•	8959.6802
	8954.6808	5	550 mm	•	8954.6802
Grasping forceps bndl with pike-mouth jaws, short 	8952.6508	5	550 mm	•	8952.6502

IX23 || Subject to modifications. Please note that some products may not be available in all countries. Please always take note of the information that is provided with the product. For more detailed information, please consult with your contact partner or directly with Richard Wolf GmbH.

THE VIPER

**FLEXIBLE FIBER URETERORENOSCOPES
270°**

FLEXIBLE FIBER URS 270°

2.2

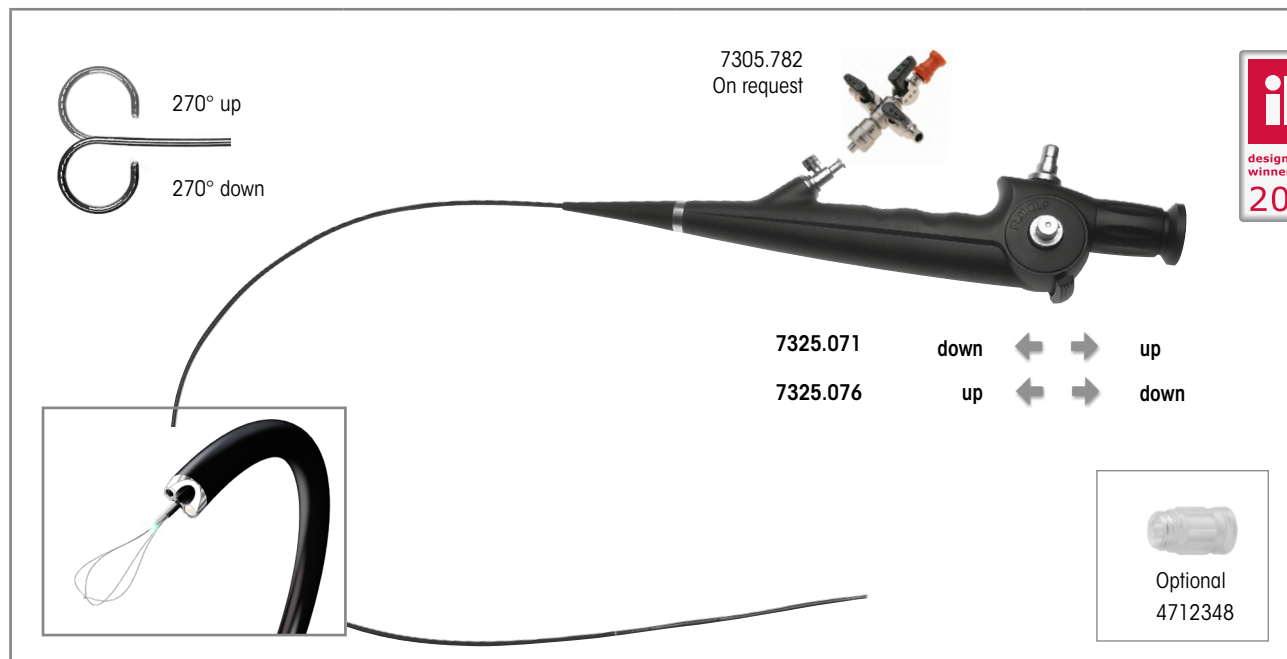





	Outer Ø	Working and laser fiber channel Ø	WL/TL	Control lever in distal direction – articulation downward	Control lever in distal direction – articulation upward	Product no.
Fiber ureterorenoscope 9.6 Fr WL 680 mm Slanted distal tip Articulation +270°/-270° Direction of view 0°, angle of view 85°	9.6 Fr	2x 3.6 Fr	WL 680 mm	•		7325.071
			TL 1005 mm		•	7325.076
Also:						
Pressure equalization valve						163.904
Leakage tester for flex. endoscopes						163.903
Adapter						163914
Clamping element, orange (20 PCS)						15394144
Cleaning brush Ø 2 mm, TL 1,200 mm (Pack = 10 PCS)						7990001
Recommended accessories						Product no.
Fiber light cable bndl consisting of: Fiber light cable Ø 2.5 mm, TL 2.3 m (80662523), projector-side adapter (8095.07), and endoscope-side adapter (809509)					Ø 2.5 mm, 2.3 m long	806625231
Perforated basket for flexible endoscopes Also: fixing ring Ø 50.39 mm					(W x H x D): 448 x 106 x 288 mm	33016 643301261
Auxiliary instruments						see URO121

IX23 || Subject to modifications. Please note that some products may not be available in all countries. Please always take note of the information that is provided with the product. For more detailed information, please consult with your contact partner or directly with Richard Wolf GmbH.

FLEXIBLE FIBER URETERORENOSCOPES













TECHNICAL DATA/ACCESSORIES AND AUXILIARY INSTRUMENTS

Fiber ureterorenoscope 9.6 Fr WL 680 mm	7325.071/7325.076
Distal tip	Slanted distal tip 6 Fr
Sheath diameter	9.6 Fr
Number of working channels	2
Working/irrigation channel diameter	3.6 Fr
Articulation	270° upward, 270° downward
Working length	680 mm
Direction of view	0°
Angle of view	85°
Eyepiece	Adjustment eyepiece with diopter adjustment
Control lever	with position catch at 0° when instrument tip is extended and brake mechanism for locking

Accessories and auxiliary instruments		Product no.
	Adapter with 2 irrigation valves and 1 instrument port, quick-release mechanism	7305.782
	Also: Luer sealing cap	15023205
	RIWO rubber cap, capacity 0.8 mm	88.01
	Universal sealing valve 1–6 Fr for inserting auxiliary instruments of 1–6 Fr	4712348
	Adapter for machine leakage tests	163.905

FLEXIBLE FIBER URETERORENOSCOPES

ACCESSORIES AND AUXILIARY INSTRUMENTS

		Fr	WL	TL	Product no.
	Flex. grasping forceps 3 Fr WL 530 mm	3	530 mm	665 mm	828.605
	Flex. grasping forceps 5 Fr WL 550 mm	5	550 mm	720 mm	828.051
 Fine tooththing	Flex. grasping forceps 3 Fr WL 920 mm	3	920 mm	1,050 mm	828.651
	Flex. biopsy forceps 5 Fr WL 550 mm	5	550 mm	720 mm	829.051
	Flex. biopsy forceps 3 Fr WL 530 mm	3	530 mm	665 mm	829.603
	Flex. biopsy forceps Ø 3 Fr WL 920 mm	3	920 mm	1,055 mm	829.601
	Flex. biopsy forceps 4 Fr WL 600 mm	4	600 mm	730 mm	8734.606
 Pike-mouth jaws	Flex. grasping forceps 4 Fr WL 600 mm	4	600 mm	750 mm	8734.656
 Mouse tooth	Flex. grasping forceps 4 Fr WL 600 mm	4	600 mm	750 mm	8734.686
	Flex. grasping forceps 5 Fr WL 550 mm	5	550 mm	700 mm	8735.685
	Flex. grasping forceps 3.5 Fr WL 550 mm, fine tooththing	3.5	550 mm	700 mm	8953.60
	Coag. electrode mono 5 Fr WL 600 mm	5	600 mm	-	8599.80
	Coag. electrode mono 3 Fr WL 580 mm	3	580 mm	-	823.031
	Hook electrode mono 2.4 Fr WL 600 mm	2.4	600 mm	-	823.221



FLEXIBLE FIBER 2-CHANNEL CONTINUOUS IRRIGATION LASER URETERORENOSCOPES

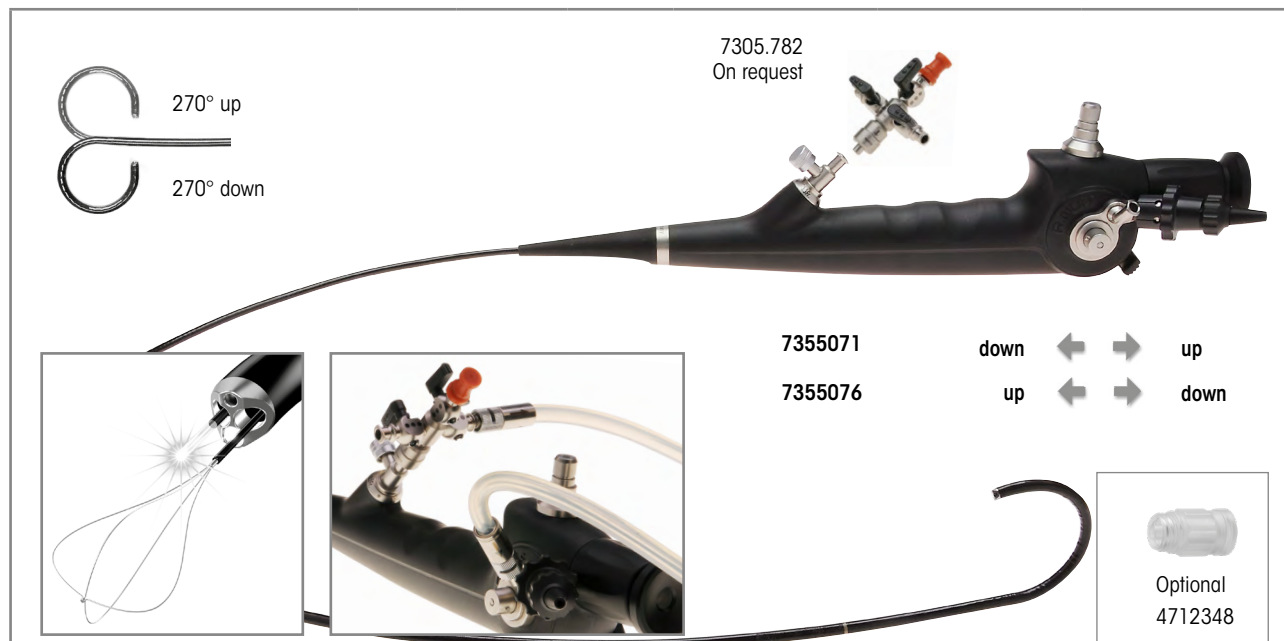

	Outer Ø	Working and laser fiber channel Ø	WL/TL	Control lever in distal direction – articulation downward	Control lever in distal direction – articulation upward	Product no.
Fiber ureterorenoscope 9.9 Fr WL 680 mm Slanted distal tip Articulation +270°/-270° Direction of view 0°, angle of view 85°	9.9 Fr	2x 3.3 Fr	WL 680 mm	•		7326071
			TL 1,010 mm		•	7326076
Fiber ureterorenoscope bndl consisting of: Fiber ureterorenoscope 9.9 Fr WL 680 mm (7326071), pressure equalization valve (163.904), leakage tester for flex. endoscopes (163.903), adapter (163914), clamping element (15394144), and cleaning brush Ø 2 mm, TL 1,200 mm (Pack = 10 PCS) (7990001)				•		732607111
Fiber ureterorenoscope bndl consisting of: Fiber ureterorenoscope 9.9 Fr WL 680 mm (7326076), pressure equalization valve (163.904), leakage tester for flex. endoscopes (163.903), adapter (163914), clamping element (15394144), and cleaning brush Ø 2 mm, TL 1,200 mm (Pack = 10 PCS) (7990001)					•	732607611
Recommended accessories						Product no.
Fiber light cable bndl consisting of: Fiber light cable Ø 2.5 mm, TL 2.3 m (80662523), projector-side adapter (8095.07), and endoscope-side adapter (809509)				Ø 2.5 mm, 2.3 m long		806625231
Perforated basket for flexible endoscopes Also: fixing ring Ø 50.39 mm				(W x H x D): 448 x 106 x 288 mm		33016
						643301261
for auxiliary instruments, see URO125						

IX23 || Subject to modifications. Please note that some products may not be available in all countries. Please always take note of the information that is provided with the product. For more detailed information, please consult with your contact partner or directly with Richard Wolf GmbH.



FLEXIBLE FIBER 2-CHANNEL CONTINUOUS IRRIGATION LASER URETERORENOSCOPES

TECHNICAL DATA

Fiber ureterorenoscope 9.9 Fr WL 680 mm	7326071/7326076
Distal tip	Slanted distal tip 6 Fr
Sheath diameter	9.9 Fr
Number of working channels	2
Working/irrigation channel diameter	3.3 Fr
Laser/irrigation channel diameter	3.3 Fr
Articulation	270° upward, 270° downward
Working length	680 mm
Direction of view	0°
Angle of view	85°
Eyepiece	Adjustment eyepiece with diopter adjustment
Control lever	with position catch at 0° when instrument tip is extended and brake mechanism for locking







ENDOCAM LOGIC HD equipment		Product no.
	<p>ENDOCAM Logic HD Lite controller bndl</p> <p>consisting of:</p> <ul style="list-style-type: none"> ENDOCAM Logic HD Lite camera control unit (5525201) Handheld remote control USB (5525401) USB flash memory 8 GB (56540028) HDMI/DVI-D cable, lockable, 3.0 m (103843) Power cable (2440.03) 5525 DVD license open-source software (64360816) 	<p>55252011</p>

IX23 || Subject to modifications. Please note that some products may not be available in all countries. Please always take note of the information that is provided with the product. For more detailed information, please consult with your contact partner or directly with Richard Wolf GmbH.



FLEXIBLE FIBER 2-CHANNEL CONTINUOUS IRRIGATION LASER URETERORENOSCOPES

ACCESSORIES AND AUXILIARY INSTRUMENTS

		Outer Ø	WL	Product no.
	Flex. biopsy forceps Ø 3 Fr WL 920 mm	3 Fr	920 mm	829.601
	Flex. grasping forceps 3 Fr WL 920 mm	3 Fr	920 mm	828.651
	Adapter with 2 irrigation valves and 1 instrument port, quick-release mechanism			7305.782
	Also: Luer sealing cap			15023205
	RIWO rubber cap, capacity 0.8 mm			88.01
	Universal sealing valve 1–6 Fr for inserting auxiliary instruments of 1–6 Fr			4712348
	Adapter for machine leakage tests			163.905
	Laser adjustment unit bndl			15369108
	Also: clamping element, orange (20 pcs)			15394144

IX23 || Subject to modifications. Please note that some products may not be available in all countries. Please always take note of the information that is provided with the product. For more detailed information, please consult with your contact partner or directly with Richard Wolf GmbH.

FLEXIBLE 1-CHANNEL SENSOR URETERORENOSCOPES

FOR ENDOCAM Logic 4K CONTROLLER

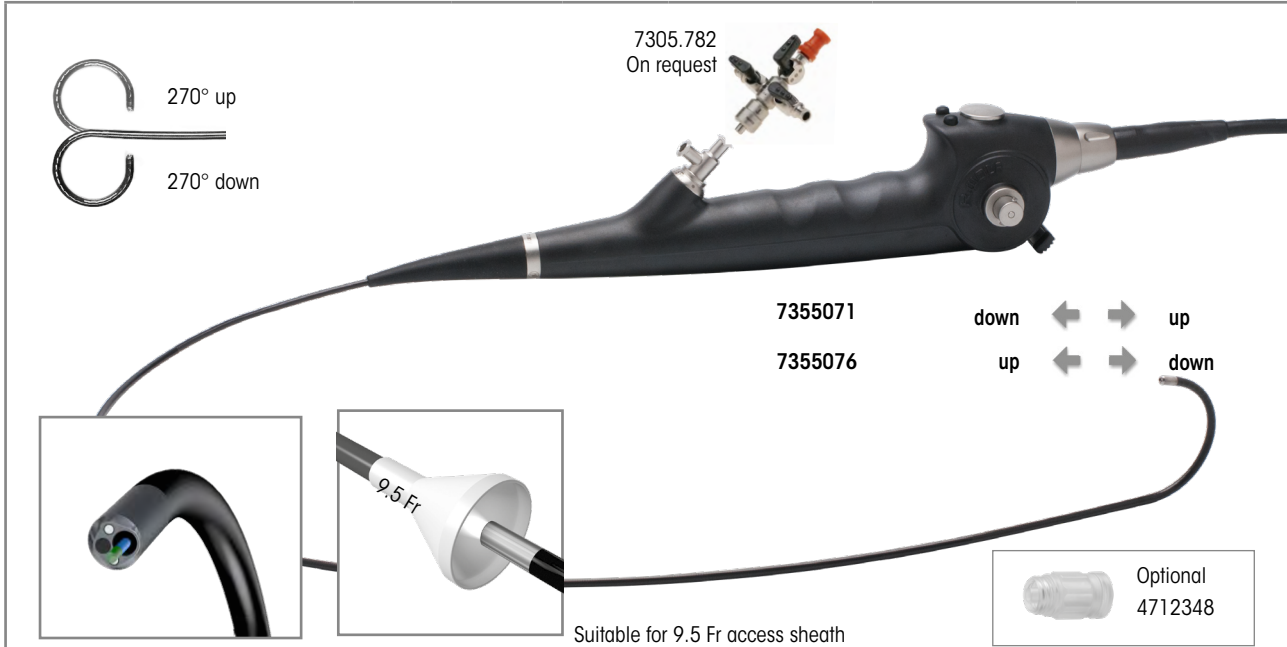

	Outer Ø	Working/irrigation channel	WL	Control lever in distal direction – articulation downward	Control lever in distal direction – articulation upward	Product no.
Sensor ureterorenoscope 8.7 Fr WL 680 mm Slanted distal tip Articulation +270°/-270° Direction of view 6.5°, angle of view 90°	8.7 Fr	3.6 Fr	680 mm	•		7355071
					•	7355076
Sensor ureterorenoscope bndl consisting of: Sensor ureterorenoscope 8.7 Fr WL 680 mm (7355071), pressure equalization valve (163.904), leakage tester for flex. endoscopes (163.903), and cleaning brush Ø 2 mm, TL 1,200 mm (Pack = 10 PCS) (7990001)				•		73550712
Sensor ureterorenoscope bndl consisting of: Sensor ureterorenoscope 8.7 Fr WL 680 mm (7355076), pressure equalization valve (163.904), leakage tester for flex. endoscopes (163.903), and cleaning brush Ø 2 mm, TL 1,200 mm (Pack = 10 PCS) (7990001)					•	73550762

Recommended accessories		Product no.
Fiber light cable bndl consisting of: Fiber light cable Ø 2.5 mm, TL 2.3 m (80662523), projector-side adapter (8095.07), and endoscope-side adapter (809509)	Ø 2.5 mm, 2.3 m long	806625231
Perforated basket for flexible endoscopes Also: fixing ring Ø 50.39 mm	(W x H x D): 448 x 106 x 288 mm	33016
for auxiliary instruments, see URO128		643301261

FLEXIBLE 1-CHANNEL SENSOR URETERORENOSCOPES

TECHNICAL DATA

Sensor ureterorenoscope 8.7 Fr WL 680 mm	7355071/7355076
Distal tip	Cylindrical, atraumatic, slanted distal stainless steel tip 6.6 Fr
Sheath diameter	8.7 Fr
Number of working channels	1
Working/irrigation channel diameter	3.6 Fr
Articulation	270° upward, 270° downward
Working length	680 mm
Angle of view	90°
Handle	Ergonomic handle design with axial cable outlet
Positioning of the working and irrigation channel in relation to the picture	At 6 o'clock
Endopicture	Square, 6x digital zoom; automatic white balance, light control, and focus
Compatible camera control unit	ENDOCAM Logic 4K ENDOCAM Logic HD

ENDOCAM LOGIC 4K – Video equipment

Product no.



ENDOCAM Logic 4K camera control unit bndl

consisting of:

ENDOCAM Logic 4K camera control unit (5525301)

Handheld remote control (5525401)

1x USB flash memory 32 GB (72321829)









1x HDMI/HDMI cable, lockable, 3.0 m (103847)

1x power cable (2440.03)

55253011

FLEXIBLE 1-CHANNEL SENSOR URETERORENOSCOPES

ACCESSORIES AND AUXILIARY INSTRUMENTS

		Outer Ø	WL	Product no.
	Flex. biopsy forceps Ø 3 Fr WL 920 mm	3 Fr	920 mm	829.601
	Flex. grasping forceps 3 Fr WL 920 mm	3 Fr	920 mm	828.651
	Laser fiber Ø 365 µm, disposable	365 µm		4875013650
	Laser fiber Ø 550 µm, disposable	550 µm		487501550
	Laser fiber Ø 365 µm, reusable	365 µm		875013650
	Laser fiber Ø 550 µm, reusable	550 µm		87501550
	Adapter with 2 irrigation valves and 1 instrument port, quick-release mechanism			7305.782
	Also: Luer sealing cap			15023205
	RIWO rubber cap, capacity 0.8 mm			88.01
	Universal sealing valve 1–6 Fr for inserting auxiliary instruments of 1–6 Fr			4712348
	Adapter for machine leakage tests			163.905

FLEXIBLE 1-CHANNEL SENSOR URETERORENOSCOPES FOR ENDOCAM Flex HD CONTROLLER

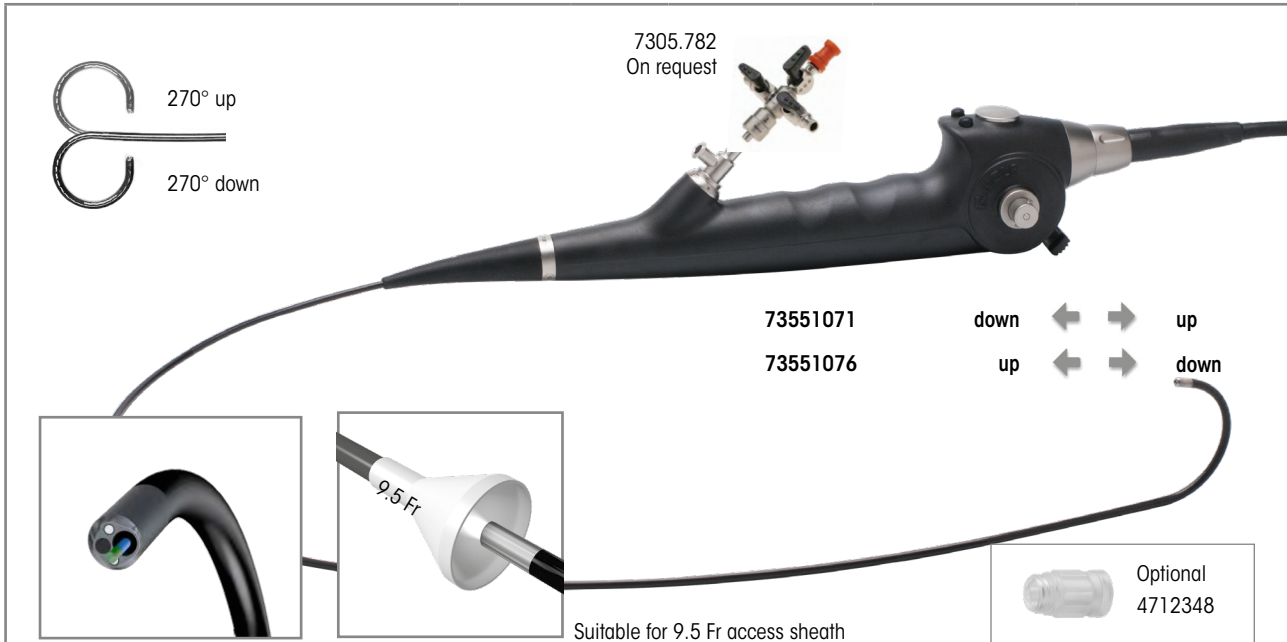

	Outer Ø	Working / irrigation channel	WL	Control lever in distal direction – articulation downward	Control lever in distal direction – articulation upward	Product no.
Sensor ureterorenoscope 8.7 Fr WL 680 mm Slanted distal tip Articulation +270°/-270° Direction of view 6.5°, angle of view 90°	8.7 Fr	3.6 Fr	680 mm	•		73551071
					•	73551076
Sensor ureterorenoscope bndl consisting of: Sensor ureterorenoscope 8.7 Fr WL 680 mm (73551071), pressure equalization valve (163.904), leakage tester for flex. endoscopes (163.903), and cleaning brush Ø 2 mm, TL 1,200 mm (Pack = 10 PCS) (7990001)				•		735510712
Sensor ureterorenoscope bndl consisting of: Sensor ureterorenoscope 8.7 Fr WL 680 mm (73551076), pressure equalization valve (163.904), leakage tester for flex. endoscopes (163.903), and cleaning brush Ø 2 mm, TL 1,200 mm (Pack = 10 PCS) (7990001)					•	735510762
Recommended accessories						Product no.
Fiber light cable bndl consisting of: Fiber light cable Ø 2.5 mm, TL 2.3 m (80662523), projector-side adapter (8095.07), and endoscope-side adapter (809509)				Ø 2.5 mm, 2.3 m long		806625231
Perforated basket for flexible endoscopes Also: fixing ring Ø 50.39 mm				(W x H x D): 448 x 106 x 288 mm		33016
						643301261
for auxiliary instruments, see URO131						

FLEXIBLE 1-CHANNEL SENSOR URS

2.4







IX23 || Subject to modifications. Please note that some products may not be available in all countries. Please always take note of the information that is provided with the product. For more detailed information, please consult with your contact partner or directly with Richard Wolf GmbH.

FLEXIBLE 1-CHANNEL SENSOR URETERORENOSCOPES

TECHNICAL DATA

Sensor ureterorenoscope 8.7 Fr WL 680 mm	73551071/73551076
Distal tip	Cylindrical, atraumatic, slanted distal stainless steel tip 6.6 Fr
Sheath diameter	8.7 Fr
Number of working channels	1
Working/irrigation channel diameter	3.6 Fr
Articulation	270° upward, 270° downward
Working length	680 mm
Angle of view	90°
Handle	Integrated LED illumination, ergonomic handle design with axial camera cable
Positioning of the working and irrigation channel in relation to the picture	At 9 o'clock
Endopicture	Square, 1.5x zoom, detail enhancement, automatic white balance and brightness control, no focusing necessary
Compatible camera control unit	ENDOCAM Logic 4K ENDOCAM Logic HD

FLEXIBLE 1-CHANNEL SENSOR URETERORENOSCOPES ACCESSORIES AND AUXILIARY INSTRUMENTS

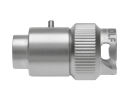
		Outer Ø	WL	Product no.
	Flex. biopsy forceps Ø 3 Fr WL 920 mm	3 Fr	920 mm	829.601
	Flex. grasping forceps 3 Fr WL 920 mm	3 Fr	920 mm	828.651
	Laser fiber Ø 365 µm, disposable	200 µm		487501200
	Laser fiber Ø 550 µm, disposable	272 µm		487501272
	Laser fiber Ø 365 µm, reusable	200 µm		87501200
	Laser fiber Ø 550 µm, reusable	272 µm		87501272
	Adapter with 2 irrigation valves and 1 instrument port, quick-release mechanism			7305.782
	Also: Luer sealing cap			15023205
	RIWO rubber cap, capacity 0.8 mm			88.01
	Universal sealing valve 1–6 Fr for inserting auxiliary instruments of 1–6 Fr			4712348
	Adapter for machine leakage tests			163.905

FLEXIBLE 2-CHANNEL SENSOR URETERORENOSCOPES

FOR ENDOCAM **Logic 4K** CONTROLLER

FLEXIBLE 2-CHANNEL SENSOR URS

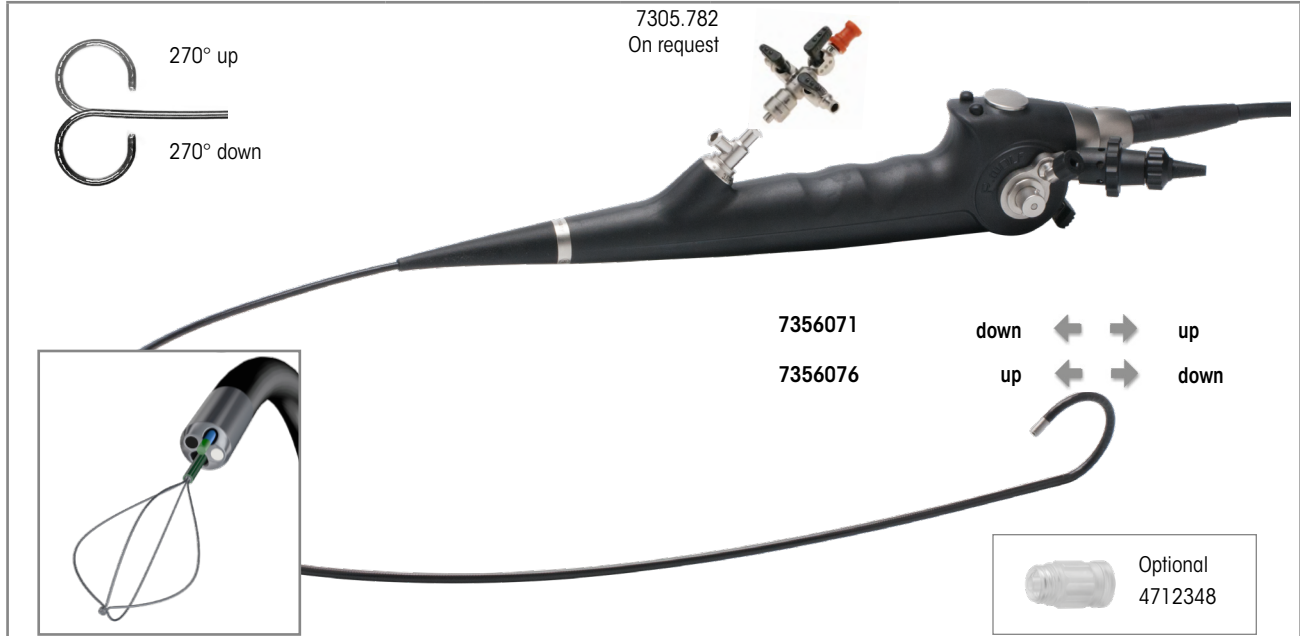

	Outer Ø	Working/laser channel	WL	Control lever in distal direction – articulation downward	Control lever in distal direction – articulation upward	Product no.
Sensor ureterorenoscope 9.9 Fr WL 680 mm Slanted distal tip Articulation +270°/-270° Direction of view 0°, angle of view 120°	9.9 Fr	Working channel 3.6 Fr laser channel 2.4 Fr	680 mm	•		7356071
					•	7356076
Sensor ureterorenoscope bndl consisting of: Sensor ureterorenoscope 9.9 Fr WL 680 mm (7356071), pressure equalization valve (163.904), leakage tester for flex. endoscopes (163.903), adapter (163914), cleaning brush Ø 2 mm, TL 1,200 mm (Pack = 10 PCS) (7990001), cleaning brush Ø 0.85 mm, TL 1,200 mm (Pack = 10 PCS) (7990003), and clamping element, orange (20 pcs) (15394144)				•		73560712
Sensor ureterorenoscope bndl consisting of: Sensor ureterorenoscope 9.9 Fr WL 680 mm (7356076), pressure equalization valve (163.904), leakage tester for flex. endoscopes (163.903), adapter (163914), cleaning brush Ø 2 mm, TL 1,200 mm (Pack = 10 PCS) (7990001), cleaning brush Ø 0.85 mm, TL 1,200 mm (Pack = 10 PCS) (7990003), and clamping element, orange (20 pcs) (15394144)					•	73560762
Recommended accessories						Product no.
Fiber light cable bndl consisting of: Fiber light cable Ø 2.5 mm, TL 2.3 m (80662523), projector-side adapter (8095.07), and endoscope-side adapter (809509)				Ø 2.5 mm, 2.3 m long		806625231
Perforated basket for flexible endoscopes Also: fixing ring Ø 50.39 mm				(W x H x D): 448 x 106 x 288 mm		33016
for auxiliary instruments, see URO134						643301261

IX23 | Subject to modifications. Please note that some products may not be available in all countries. Please always take note of the information that is provided with the product. For more detailed information, please consult with your contact partner or directly with Richard Wolf GmbH.

FLEXIBLE 2-CHANNEL SENSOR URETERORENOSCOPES

TECHNICAL DATA









Sensor ureterorenoscope 9.9 Fr WL 680 mm	7356071/7356076
Distal tip	Cylindrical, atraumatic, slanted distal stainless steel tip 5.2 Fr
Sheath diameter	9.9 Fr
Number of working channels	2
Working/irrigation channel diameter	3.6 Fr
Laser/irrigation channel diameter	2.4 Fr
Articulation	270° upward, 270° downward
Working length	680 mm
Angle of view	90°
Handle	Ergonomic handle design with axial cable outlet
Positioning of the working and irrigation channel in relation to the picture	At 6 o'clock
Positioning of the laser and irrigation channel in relation to the picture	At 9 o'clock
Endopicture	Square, 6x digital zoom; automatic white balance, light control, and focus
Compatible camera control unit	ENDOCAM Logic 4K ENDOCAM Logic HD

IX23 || Subject to modifications. Please note that some products may not be available in all countries. Please always take note of the information that is provided with the product. For more detailed information, please consult with your contact partner or directly with Richard Wolf GmbH.

ENDOCAM LOGIC 4K – Video equipment	Product no.
 <p>ENDOCAM Logic 4K camera control unit bndl consisting of: ENDOCAM Logic 4K camera control unit (5525301) Handheld remote control (5525401) 1x USB flash memory 32 GB (72321829) 1x HDMI/HDMI cable, lockable, 3.0 m (103847) 1x power cable (2440.03)</p>	<p>55253011</p>

FLEXIBLE 2-CHANNEL SENSOR URETERORENOSCOPES

ACCESSORIES AND AUXILIARY INSTRUMENTS

		Outer Ø	WL	Product no.
	Flex. biopsy forceps Ø 3 Fr WL 920 mm	3 Fr	920 mm	829.601
	Flex. grasping forceps 3 Fr WL 920 mm	3 Fr	920 mm	828.651
	Adapter with 2 irrigation valves and 1 instrument port, quick-release mechanism			7305.782
	Also: Luer sealing cap			15023205
	RIWO rubber cap, capacity 0.8 mm			88.01
	Universal sealing valve 1–6 Fr for inserting auxiliary instruments of 1–6 Fr			4712348
	Adapter for machine leakage tests			163.905
	Laser adjustment unit bndl			15369108
	Also: clamping element, orange (20 pcs)			15394144

IX23 || Subject to modifications. Please note that some products may not be available in all countries. Please always take note of the information that is provided with the product. For more detailed information, please consult with your contact partner or directly with Richard Wolf GmbH.

FLEXIBLE 2-CHANNEL SENSOR URETERORENOSCOPES FOR ENDOCAM Flex HD CONTROLLER

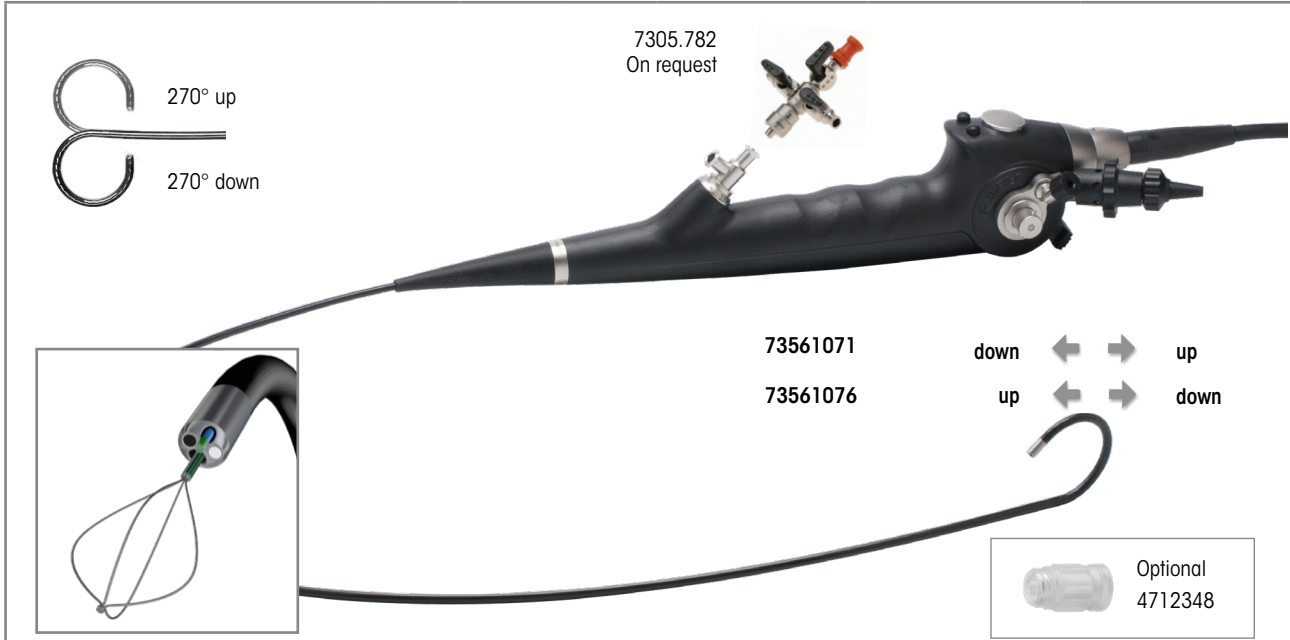

	Outer Ø	Working/Laser channel	WL	Control lever in distal direction – articulation downward	Control lever in distal direction – articulation upward	Product no.
Sensor ureterorenoscope 9.9 Fr WL 680 mm Slanted distal tip Articulation +270°/-270° Direction of view 0°, angle of view 90°	9.9 Fr	Working channel 3.6 Fr Laser channel 2.4 Fr	680 mm	•		73561071
					•	73561076
Sensor ureterorenoscope bndl consisting of: Sensor ureterorenoscope 9.9 Fr WL 680 mm (73561071), pressure equalization valve (163.904), leakage tester for flex. endoscopes (163.903), adapter (163914), cleaning brush Ø 2 mm, TL 1,200 mm (Pack = 10 PCS) (7990001), cleaning brush Ø 0.85 mm, TL 1,200 mm (Pack = 10 PCS) (7990003), and clamping element, orange (20 pcs) (15394144)				•		735610712
Sensor ureterorenoscope bndl consisting of: Sensor ureterorenoscope 9.9 Fr WL 680 mm (73561076), pressure equalization valve (163.904), leakage tester for flex. endoscopes (163.903), adapter (163914), cleaning brush Ø 2 mm, TL 1,200 mm (Pack = 10 PCS) (7990001), cleaning brush Ø 0.85 mm, TL 1,200 mm (Pack = 10 PCS) (7990003), and clamping element, orange (20 pcs) (15394144)					•	735610762
Recommended accessories						Product no.
Fiber light cable bndl consisting of: Fiber light cable Ø 2.5 mm, TL 2.3 m (80662523), projector-side adapter (8095.07), and endoscope-side adapter (809509)				Ø 2.5 mm, 2.3 m long		806625231
Perforated basket for flexible endoscopes Also: fixing ring Ø 50.39 mm				(W x H x D): 448 x 106 x 288 mm		33016
						643301261
for auxiliary instruments, see URO137						

FLEXIBLE 2-CHANNEL SENSOR URS

2.5

IX23 || Subject to modifications. Please note that some products may not be available in all countries. Please always take note of the information that is provided with the product. For more detailed information, please consult with your contact partner or directly with Richard Wolf GmbH.









FLEXIBLE 2-CHANNEL SENSOR URETERORENOSCOPES

TECHNICAL DATA

Sensor ureterorenoscope 9.9 Fr WL 680 mm	73561071/73561076
Distal tip	Cylindrical, atraumatic, slanted distal stainless steel tip 5.2 Fr
Sheath diameter	9.9 Fr
Number of working channels	2
Working/irrigation channel diameter	3.6 Fr
Laser/irrigation channel diameter	2.4 Fr
Articulation	270° upward, 270° downward
Working length	680 mm
Angle of view	90°
Handle	Integrated LED illumination, ergonomic handle design with axial camera cable
Positioning of the working and irrigation channel in relation to the picture	At 6 o'clock
Positioning of the laser and irrigation channel in relation to the picture	At 9 o'clock
Endopicture	Square, 1.5x zoom, detail enhancement, automatic white balance and brightness control, no focusing necessary
Compatible camera control unit	ENDOCAM Logic 4K ENDOCAM Logic HD

FLEXIBLE 2-CHANNEL SENSOR URETERORENOSCOPES

ACCESSORIES AND AUXILIARY INSTRUMENTS

		Outer Ø	WL	Product no.
	Flex. biopsy forceps Ø 3 Fr WL 920 mm	3 Fr	920 mm	829.601
	Flex. grasping forceps 3 Fr WL 920 mm	3 Fr	920 mm	828.651
	Adapter with 2 irrigation valves and 1 instrument port, quick-release mechanism			7305.782
	Also: Luer sealing cap			15023205
	RIWO rubber cap, capacity 0.8 mm			88.01
	Universal sealing valve 1–6 Fr for inserting auxiliary instruments of 1–6 Fr			4712348
	Adapter for machine leakage tests			163.905
	Laser adjustment unit bndl			15369108
	Also: clamping element, orange (20 pcs)			15394144

RIWO 
D-URS

DISPOSABLE SENSOR URETERORENOSCOPE

DISPOSABLE SENSOR URS – RIWO D-URS



	Fr	WL	Product no.
Sensor ureterorenoscope 9 Fr WL 600 mm (Pack = 3 PCS)	9 Fr	600 mm	473572076

IX23 || Subject to modifications. Please note that some products may not be available in all countries. Please always take note of the information that is provided with the product. For more detailed information, please consult with your contact partner or directly with Richard Wolf GmbH.

RIWO D-URS

TECHNICAL DATA

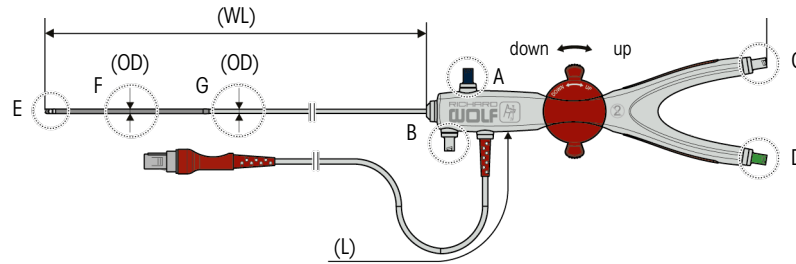
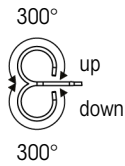

Sensor ureterorenoscope 9 Fr WL 600 mm 473572076

Working length (WL)	600 mm
Cable length (L)	2,500 mm
Outer diameter (OD) (flexible area) F	9 Fr
Outer diameter (OD) (semi-rigid area) G	8.1 Fr
Distal instrument tip E	6 Fr
Working channel (C)	3.6 Fr
Laser fiber channel (D)	1.65 Fr
Articulation	+/-300° (up/down)
Direction of view	0°
Angle of view	90°
Luer connection for inlet, color: blue A	Ø 3.0 mm
Luer connection for outlet, color: gray B	Ø 3.0 mm
Luer connection for working channel, color: gray C	Ø 3.0 mm
Luer connection for laser fiber channel, color: green D	Ø 3.0 mm
Operating conditions	Temperature: +10 °C to +40 °C, rel. humidity: 20 % to 75 %, atmospheric pressure: 700 hPa to 1,060 hPa
Storage conditions	Temperature: +5 °C to +30 °C, rel. humidity: 10 % to 70 %, atmospheric pressure: 700 hPa to 1,060 hPa

DISPOSABLE SENSOR URS – RIWO D-URS

2.6

IX23 || Subject to modifications. Please note that some products may not be available in all countries. Please always take note of the information that is provided with the product. For more detailed information, please consult with your contact partner or directly with Richard Wolf GmbH.

RIWO 
D-URS

CAMERA CONTROL UNIT AND ACCESSORIES



Adapter for control unit 5525 5525410

The sensor ureterorenoscope is compatible with the following Richard Wolf camera control units* using the adapter (5525410) for control unit 5525:

- 5525101 Logic HD camera control unit
- 2525301 Logic 4K camera control unit
- 5525201 Logic HD life camera control unit

* Software version V2.0.9 or higher







ENDOCAM D camera control unit bndl 55221011

consisting of:

- 1x ENDOCAM D camera control unit 5522101
 - 1x Vector Plus coax cable 3.00 m DZGR-0300-SW-GN
 - 1x HDMI/DVI-D cable, lockable 3.0 m 103843
 - 1x license for open-source software 72321911
 - 1x power cable 3 m long 2440.03
- (see rear for technical data)

Also:

Handheld remote control USB 5525401

		Outer Ø	WL	Product no.
Flex. biopsy forceps Ø 3 Fr WL 920 mm		3 Fr	920 mm	829.601
Flex. grasping forceps 3 Fr WL 920 mm		3 Fr	920 mm	828.651
		Ø	L	Product no.
Power laser fiber Ø 200 µm, disposable		200 µm	3.0 m	487502200
Laser fiber Ø 200 µm, disposable		200 µm	3.0 m	487501200
Laser fiber Ø 272 µm, disposable		272 µm	3.0 m	487501272
These particular laser fibers are compatible with the Richard Wolf MegaPulse 30 ⁺ and MegaPulse 70 ⁺ lasers.				
				Product no.
Universal sealing valve 1–6 Fr (Pack = 5 PCS) sterile, for single use for inserting auxiliary instruments 1–6 Fr				4712348
Luer sealing cap				15023205
RIWO rubber cap, capacity 0.8 mm				88.01

IX23 | Subject to modifications. Please note that some products may not be available in all countries. Please always take note of the information that is provided with the product. For more detailed information, please consult with your contact partner or directly with Richard Wolf GmbH.

TECHNICAL DATA OF ENDOCAM D CAMERA CONTROL UNIT

D camera control unit		5522101
Device properties		
Type of controls	Mechanical buttons	
Max. video signal resolution	1,920 x 1,080 pixels	
Brightness control	Automatic shutter control + automatic gain control	
Digital zoom	2.5x max.	
Operating conditions	+10 °C to +40 °C, 30 % to 75 % rel. humidity, atmospheric pressure 700 hPa to 1,060 hPa	
Storage and transport conditions	-20 °C to +60 °C, 10 % to 90 % rel. humidity, atmospheric pressure 700 hPa to 1,060 hPa	
Operating mode	Continuous operation	
Equipment		
IP rating	IP 20	
Power supply		
Mains + frequency	100–240 V AC, 50/60 Hz	
Power consumption	32 VA	
Current consumption	0.32–0.13 A	
Fuse	T 1.25 AH 250 V	
Regulatory standards		
Safety	UL 2601-1/CSA C22.2 No.601.1 – for USA	
EMC	EN/IEC 60601-1-2	
Medical device class	Class 1	
Classification of applied part	CF	
Interfaces		
Video outputs	1x 3G-SDI, 1x HDMI	
USB port (on front panel, for external storage media)	USB 2.0 (FAT32/NTFS formatting)	
Resolution (HDMI output)	Adjustable via DIP switches on housing rear	
	SXGA	1,280 x 1,024 p (50 Hz) (5:4)
	Full HD	1,920 x 1,080 p (60 Hz) (16:9)
Resolution (3G-SDI output)	1,920 x 1,080 p (60 Hz)	
Dimensions and weights		
Weight	2.3 kg	
Dimensions (W x H x D)	200 x 60 x 220 mm	

DILATORS

FOR PERCUTANEOUS UNIVERSAL NEPHROSCOPES



8955.185/27

AUTOCLAVE
134° C / 273° F

for dilatation of the puncture channel		Outer Ø	TL	Product no.
Dilator 6 Fr	Cannulated	6 Fr	500 mm	8955.06
Telescopic dilator 9–18 Fr bndl	consisting of: dilator 6 Fr (8955.06)	6 Fr	230 mm	8955.180
	Telescopic dilator 9 Fr (8955.091)	9 Fr		
	Telescopic dilator 12 Fr (8955.121)	12 Fr		
	Telescopic dilator 15 Fr (8955.151)	15 Fr		
	Telescopic dilator 18 Fr (8955.181)	18 Fr		
Telescopic dilator 9–27 Fr bndl	consisting of: dilator 6 Fr (8955.06)	6 Fr	230 mm	8955270
	Telescopic dilator 9 Fr (8955.091)	9 Fr		
	Telescopic dilator 12 Fr (8955.121)	12 Fr		
	Telescopic dilator 15 Fr (8955.151)	15 Fr		
	Telescopic dilator 18 Fr (8955.181)	18 Fr		
	Telescopic dilator 21 Fr (8955.211)	21 Fr		
	Telescopic dilator 24 Fr (8955.241)	24 Fr		
	Telescopic dilator 27 Fr (8955.271)	27 Fr		
Dilator 12 Fr	Cannulated, for one-step bouginage	12 Fr	320 mm	8968.012
Dilator 15 Fr	Cannulated, for one-step bouginage	15 Fr	320 mm	8968.015
Dilator 30 Fr	Fits the 27 Fr dilator from 8955.27	30 Fr	230 mm	8955.308
Dilator 9 Fr	for inserting a second guide wire	9 Fr	600 mm	8962.19

IX23 || Subject to modifications. Please note that some products may not be available in all countries. Please always take note of the information that is provided with the product. For more detailed information, please consult with your contact partner or directly with Richard Wolf GmbH.

MINI NEPHROSCOPE 15/18 Fr

BY LAHME

ALSO SUITABLE FOR CHILDREN AND ADOLESCENTS

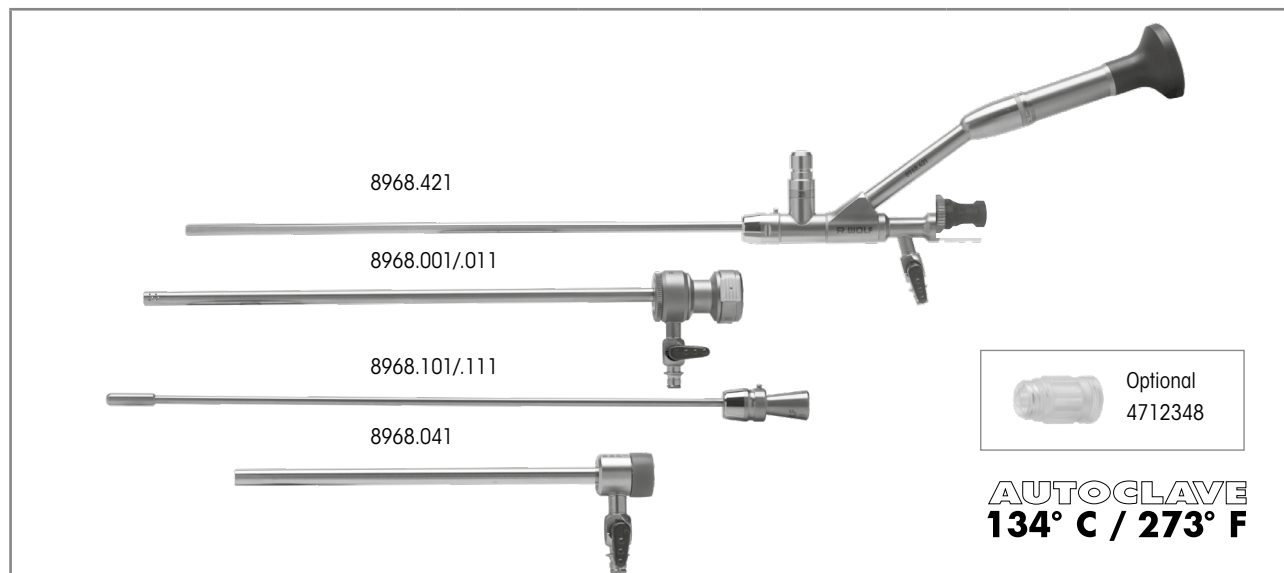

PANOVIEW	Direction of view	Ø	Maximum capacity	WL/SL	TL	Product no.
Nephroscope 12° 12 Fr WL 225 mm with laterally offset eyepiece Working channel for instruments up to 6 Fr	12°	12 Fr	6 Fr (2 mm)	WL 225 mm	406 mm	8968.421
Sheath for nephroscope 15 Fr	-	15 Fr	12 Fr (4 mm)	SL 205 mm	-	8968.001
Obturator for nephroscope 15 Fr	-	-	3.5 Fr (1.2 mm)	229 mm	-	8968.101
Sheath for nephroscope 18 Fr Round, rotatable irrigation valve	-	18 Fr	15 Fr (5 mm)	SL 205 mm	-	8968.011
Sheath for nephroscope 18 Fr Round, fixed irrigation valve	-	18 Fr	15 Fr (5 mm)	SL 150 mm	-	8968.041
Obturator for nephroscope 18 Fr	-	-	3.5 Fr (1.2 mm)	WL 229 mm	-	8968.111

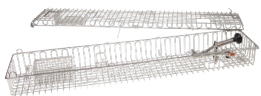
Recommended accessories		Product no.
for inserting auxiliary instruments of 1–6 Fr: universal sealing valve 1–6 Fr , sterile (Pack = 5 PCS)		4712348
Fiber light cable bndl consisting of: Fiber light cable (80662523), projector-side adapter (8095.07), and endoscope-side adapter (809509)	Ø 2.5 mm, 2.3 m long	806625231
Perforated basket, upper urinary tract 1 with small part basket	 Internal dimensions (W x H x D): 619 x 65 x 124 mm External dimensions (W x H x D): 635 x 75 x 132 mm	38003
Marking pen	Color: black	38201.948

AUXILIARY INSTRUMENTS

FOR MINIATURE NEPHROSCOPE

15/18 Fr LAHME

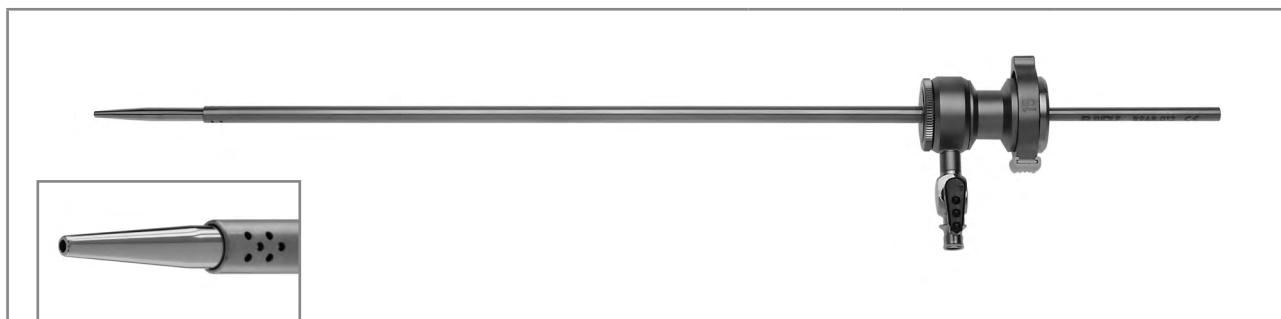

"One-step" bouginage		Outer Ø	TL	Product no.
Dilator 12 Fr	Cannulated, for one-step bouginage	12 Fr	320 mm	8968.012
Dilator 15 Fr	Cannulated, for one-step bouginage	15 Fr	320 mm	8968.015

Note: Can also be used with telescopic dilators, of course.

Further accessories	Outer Ø	WL	Product no.
Sonotrode Ø 1.9 mm WL 361 mm	1.9 mm	361 mm	8962.519
LithoClast probe Ø 2.0 mm, WL 425 mm	2.0 mm	425 mm	8742.004
Membrane holder			15256.393
Membrane holder			15256.456
Seal Ø 7.5 mm	7.5 mm		89.101
Universal sealing valve 1–6 Fr, sterile (Pack = 5 PCS)			4712348





IX23 || Subject to modifications. Please note that some products may not be available in all countries. Please always take note of the information that is provided with the product. For more detailed information, please consult with your contact partner or directly with Richard Wolf GmbH.

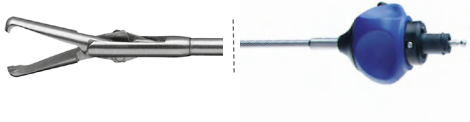

AUXILIARY INSTRUMENTS

FOR MINIATURE NEPHROSCOPE

15/18 Fr LAHME

IX23 || Subject to modifications. Please note that some products may not be available in all countries. Please always take note of the information that is provided with the product. For more detailed information, please consult with your contact partner or directly with Richard Wolf GmbH.

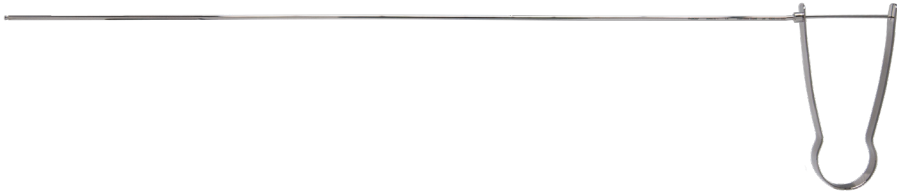
Grasping forceps jaw insert with sheath				Handle with overload protection	Complete instrument • Jaw section • Handle
 					
	Product no.	Fr	WL	8083.001	Product no.
Grasping forceps bndl Mouse tooth 	8959.6218	5 Fr	425 mm	•	8959.6212
Grasping forceps bndl Pike-mouth jaws 	8968.6808	6 Fr	425 mm	•	8968.6802

					
Grasping forceps		Outer Ø	WL	TL	Product no.
	Rigid grasping forceps 6 Fr WL 365 mm Three arms, detachable	6 Fr	365 mm	410 mm	8968.671
	Grasping forceps jaw insert 6 Fr Three arms, detachable	6 Fr	365 mm	-	8968.675

PERCUTANEOUS UNIVERSAL NEPHROSCOPE

"DRESDEN" MODEL

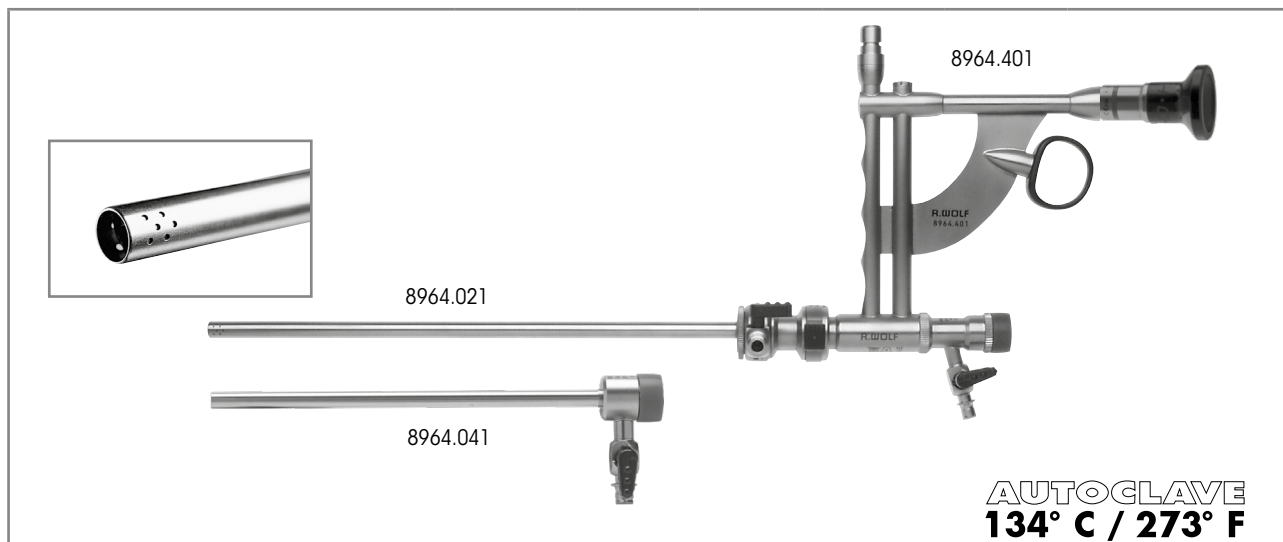

PANOVIEW	Direction of view	Ø	Maximum capacity	WL/SL	TL	Product no.
Nephroscope 12° 20.8 Fr WL 224 mm with parallel eyepiece working channel for instruments up to 10.5 Fr	12°	20.8 Fr	3.5 mm	WL 224 mm	387 mm	8964.401
Sheath for nephroscope 20.8 Fr	-	20.8 Fr	-	SL 204 mm	-	8964.021
Obturator for nephroscope 20.8 Fr	-	20.8 Fr	-	WL 230 mm	-	8964.121
Alternative:						
Sheath for nephroscope 24 Fr	-	24 Fr	-	SL 204 mm	-	8965.041
Also: obturator for nephroscope 24 Fr	-	24 Fr	-	WL 229 mm	-	8965.141
Amplatz sheath for nephroscope 24.3 Fr	-	24.3 Fr	-	SL 150 mm	-	8964.041
Sealing element						15176.100

Option of optical percutaneous ureterotomy:		Product no.
Working element, urethrotome, passive 0°	Receptacle for stricture scalpels	8670.911
Telescope 0° Ø 3.3 mm WL 297 mm		8660.424
Scalpel 16.5 Fr ceramic, lancet-shaped	12 o'clock cutting position, with ceramic cutter	8670.981

IX23 | Subject to modifications. Please note that some products may not be available in all countries. Please always take note of the information that is provided with the product. For more detailed information, please consult with your contact partner or directly with Richard Wolf GmbH.

PERCUTANEOUS UNIVERSAL NEPHROSCOPES

24 Fr

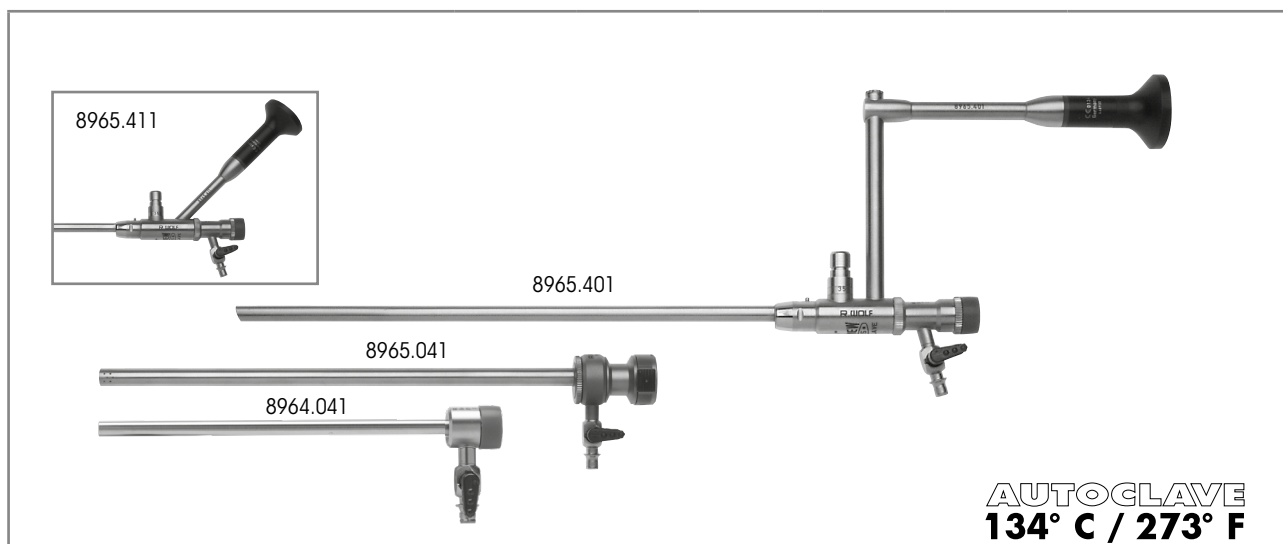

PANOVIEW	Direction of view	Ø	Maximum capacity	WL/SL	TL	Product no.
Nephroscope 20° 24 Fr WL 224 mm with parallel eyepiece working channel for instruments up to 10.5 Fr	20°	24 Fr	3.5 mm	WL 224 mm	387 mm	8965.401
Nephroscope 20° 24 Fr WL 224 mm with lateral eyepiece working channel for instruments up to 10.5 Fr	20°	24 Fr	3.5 mm	WL 224 mm	387 mm	8965.411
Sheath for nephroscope 20.8 Fr	-	20.8 Fr	-	SL 204 mm	-	8964.021
Obturator for nephroscope 20.8 Fr	-	20.8 Fr	-	WL 230 mm	-	8964.121
Alternative:						
Sheath for nephroscope 24 Fr	-	24 Fr	-	SL 204 mm	-	8965.041
Also: obturator for nephroscope 24 Fr	-	24 Fr	-	WL 229 mm	-	8965.141
Amplatz sheath for nephroscope 24.3 Fr	-	24.3 Fr	-	SL 150 mm	-	8964.041
Sealing element						15176.100
Option of optical percutaneous ureterotomy:						Product no.
Working element, urethrotome, passive 0°	Receptacle for stricture scalpels					8670.911
Telescope 0° Ø 4 mm WL 298 mm						8650.414
Scalpel 20.5 Fr ceramic, lancet-shaped	12 o'clock cutting position, with ceramic cutter					8667.981

PERCUTANEOUS UNIVERSAL NEPHROSCOPES

2.10

IX23 || Subject to modifications. Please note that some products may not be available in all countries. Please always take note of the information that is provided with the product. For more detailed information, please consult with your contact partner or directly with Richard Wolf GmbH.

PERCUTANEOUS UNIVERSAL NEPHROSCOPE

LONG VERSION FOR OBESE PATIENTS

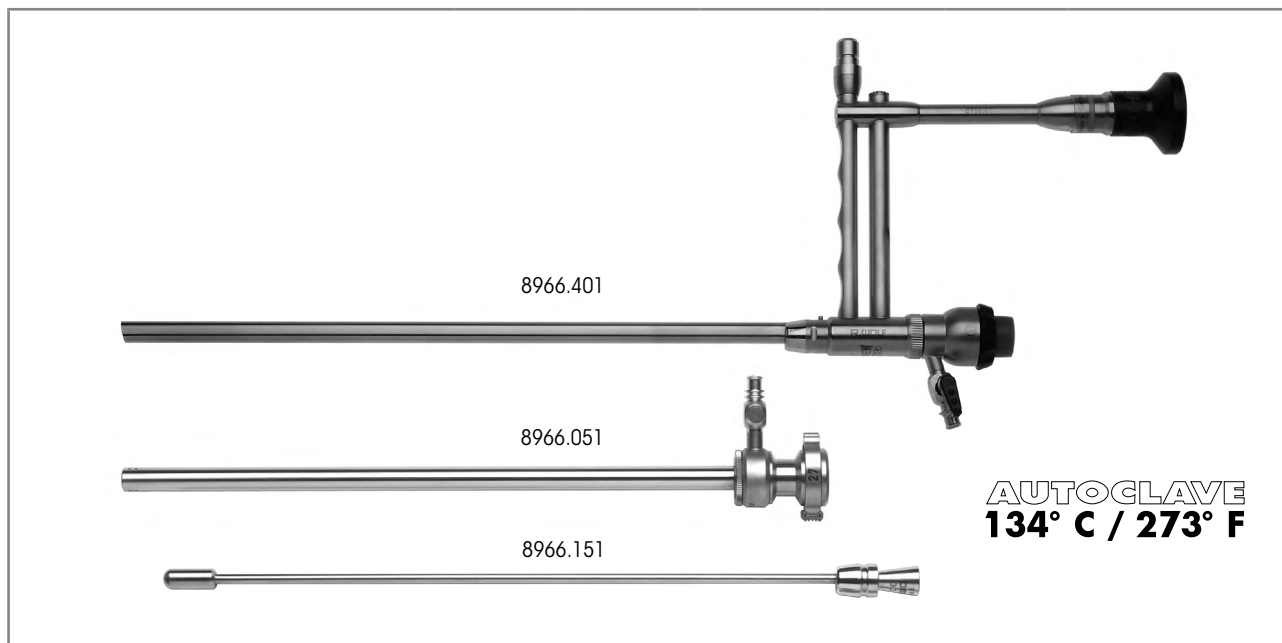





PANOVIEW	Direction of view	Ø	Maximum capacity	WL/SL	TL	Product no.
Nephroscope bndl	consisting of: Nephroscope 12° 27 Fr WL 250 mm (8966.401) Sealing membrane Ø 17 mm (89.103) Sealing cap capacity 3.4–5.1 mm (89.03) (Pack = 10 PCS) Sealing element (15176.106)					89664011
Nephroscope 12° 27 Fr WL 250 mm with parallel eyepiece	12°	24 Fr	3.5 mm	WL 224 mm	387 mm	8966.401
Sheath for nephroscope 27 Fr	-	27 Fr	-	SL 230 mm	-	8966.051
Obturator for nephroscope 27 Fr	-	27 Fr	-	WL 256 mm	-	8966.151

PERCUTANEOUS UNIVERSAL NEPHROSCOPES

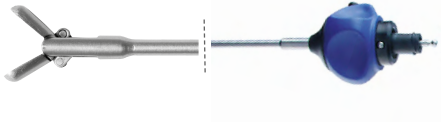

2.10

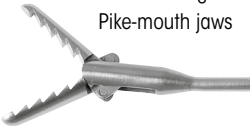
IX23 || Subject to modifications. Please note that some products may not be available in all countries. Please always take note of the information that is provided with the product. For more detailed information, please consult with your contact partner or directly with Richard Wolf GmbH.

AUXILIARY INSTRUMENTS FOR PERCUTANEOUS UNIVERSAL NEPHROSCOPES







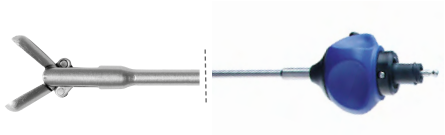

Grasping forceps jaw insert with sheath				Handle with overload protection	Complete instrument • Jaw section • Handle
 					
	Product no.	Fr	WL	8083.001	Product no.
 <p>Grasping forceps bndl Distal angled Pike-mouth jaws</p>	8962.6028	9 Fr	355 mm	•	8962.6022
 <p>Grasping forceps bndl Pike-mouth jaws</p>	8962.6108	10.5 Fr	350 mm	•	8962.6102

Grasping forceps		Outer Ø	WL	TL	Product no.
 <p>Rigid grasping forceps 10.5 Fr WL 365 mm Three arms, detachable</p>		10.5 Fr	365 mm	410 mm	8964.671

Further accessories		Product no.
<p>Fiber light cable bndl consisting of: Fiber light cable (80663523), projector-side adapter (8095.07), and endoscope-side adapter (809509)</p>		<p>Ø 3.5 mm, 2.3 m long</p> <p>806635231</p>
<p>Perforated basket for nephroscope with small part basket</p>		<p>Internal dimensions (W x H x D): 451 x 65 x 164 mm External dimensions (W x H x D): 467 x 75 x 172 mm</p> <p>38011</p>

RIGID AUXILIARY INSTRUMENTS

FORCEPS AND SCISSORS, SMALL MODULAR SYSTEM **HySafe**
 360° ROTATABLE, CAN BE FLUSHED THROUGH, EASY-CLICK

Grasping forceps jaw insert with sheath				Handle with overload protection	Complete instrument • Jaw section • Handle	
						
	Product no.	Fr	WL	8083.001	Product no.	
	Grasping forceps bndl Pike-mouth jaws	8962.6008	10.5 Fr	350 mm	•	8962.6002
		8962.6048	12 Fr	355 mm	•	8962.6042
	Grasping forceps bndl Distal angled Pike-mouth jaws	8962.6028	9 Fr	355 mm	•	8962.6022
	Grasping forceps bndl Pike-mouth jaws	8962.6108	10.5 Fr	350 mm	•	8962.6102
	Grasping forceps bndl Peanut shape, fine toothing	8962.6078	12 Fr	340 mm	•	8962.6072
	Grasping forceps bndl Mouse tooth	8962.6058	12 Fr	340 mm	•	8962.6052
	Grasping forceps bndl Pike-mouth jaws	8962.6808	6 Fr	425 mm	•	8968.6802

IX23 || Subject to modifications. Please note that some products may not be available in all countries. Please always take note of the information that is provided with the product. For more detailed information, please consult with your contact partner or directly with Richard Wolf GmbH.

PERCUTANEOUS UNIVERSAL NEPHROSCOPES
2.10

FLEXIBLE FIBER NEPHROSCOPE 5 MM/15 Fr

CHANNEL 2.5 MM/7.5 Fr

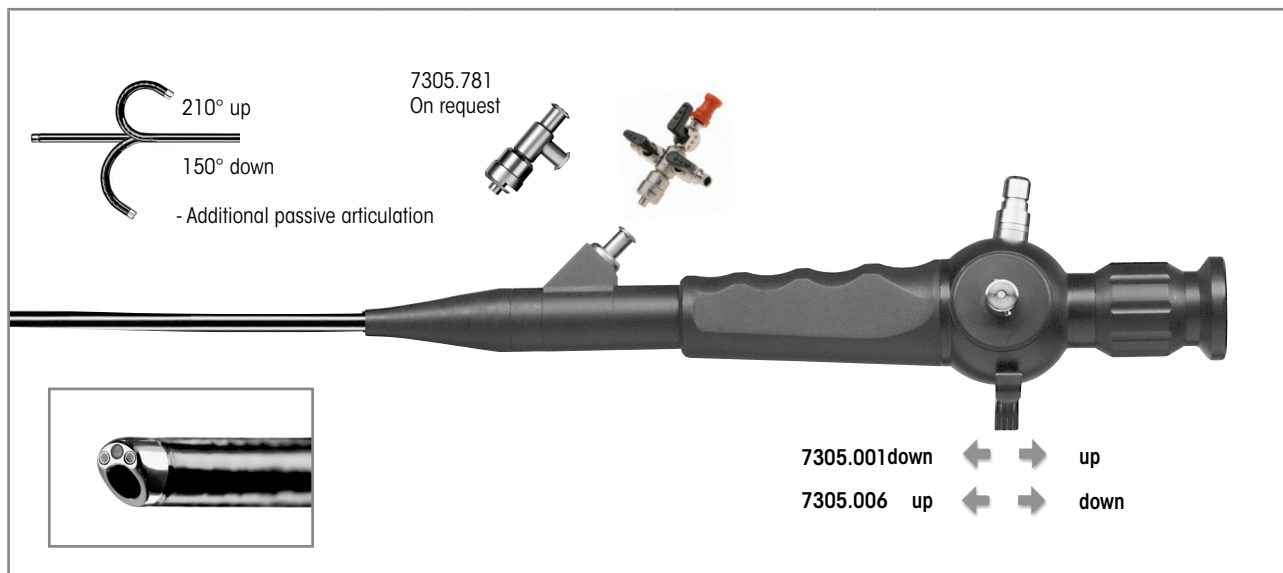

	Outer Ø	Working channel	WL	Control lever in distal direction – articulation downward	Control lever in distal direction – articulation upward	Product no.
Fiber cystoscope 15 Fr WL 400 mm Slanted distal tip Articulation +210°/-150° Direction of view 0°, angle of view 110°	15 Fr	7.5 Fr	400 mm	•		7305.001
				•	7305.006	
Fiber cystoscope bndl consisting of: Fiber cystoscope 15 Fr WL 400 mm (7305.001) Adapter with 2 irrigation valves and 1 instrument port (7305.782) Leakage tester for flex. endoscopes (163.903) Pressure equalization valve (163.904) Cleaning brush Ø 3 mm, TL 1,200 mm (Pack = 10 PCS) (7990002)				•		730500111
Fiber cystoscope bndl consisting of: Fiber cystoscope 15 Fr WL 400 mm (7305.006) Adapter with 2 irrigation valves and 1 instrument port (7305.782) Leakage tester for flex. endoscopes (163.903) Pressure equalization valve (163.904) Cleaning brush Ø 3 mm, TL 1,200 mm (Pack = 10 PCS) (7990002)					•	730500611

Recommended accessories		Product no.
Fiber light cable bndl consisting of: Fiber light cable Ø 2.5 mm, TL 2.3 m (80662523), projector-side adapter (8095.07), and endoscope-side adapter (809509)		Ø 2.5 mm, 2.3 m long 806625231
Perforated basket for flexible endoscopes Also: fixing ring Ø 50.39 mm		(W x H x D): 448 x 106 x 288 mm 33016 643301261
Flexible auxiliary instruments		see section Auxiliary instruments

IX23 || Subject to modifications. Please note that some products may not be available in all countries. Please always take note of the information that is provided with the product. For more detailed information, please consult with your contact partner or directly with Richard Wolf GmbH.

FLEXIBLE FIBER NEPHROSCOPE 5 MM/15 Fr

TECHNICAL DATA

Fiber cystoscope 15 Fr WL 400 mm	7305.001/7305.006
Distal tip	Slanted distal tip
Sheath diameter	15 Fr
Number of working channels	1
Working/irrigation channel diameter	7.5 Fr
Articulation	210° upward, 150° downward
Working length	400 mm
Angle of view	110°
Direction of view	0°

MEGA Pulse 70⁺

70 W HOLMIUM:YAG LASER SYSTEM FOR STONE AND BPH THERAPY



	Product no.
<p>MegaPulse 70+ Laser surgical device tower EU bndI consisting of: MegaPulse 70+ laser surgical device tower 70 W (2286007) 2x laser protection goggles (OBM003603) 1x key set (2286525) 1x door contact plug (2286520) 2x blast shield with mounting (OAM001523) 1x filling bottle with tube (IAM000088) 1x 2-pedal footswitch (2030232) 1x fiber-stripping forceps for stripping laser fibers, 0.3 to 1.0 mm (2286523) 1x fiber-stripping forceps for stripping laser fibers, 0.1 to 0.4 mm (2286527) 1x ceramic cutter with silicone pad (AGM000080) 1x accessories box for MegaPulse (KBM000103) 1x power cable TL 3 m (2286230)</p>	<p>22860070</p>

"MEGA PULSE 70+" LASER

2.12

IX23 || Subject to modifications. Please note that some products may not be available in all countries. Please always take note of the information that is provided with the product. For more detailed information, please consult with your contact partner or directly with Richard Wolf GmbH.

MEGA Pulse 70⁺

TECHNICAL DATA

MEGA Pulse 70 ⁺		22860070
Device properties		
Display	12" touchscreen	
Power	70 watts	
Laser type	Holmium:YAG laser (Ho:YAG)	
Wavelength	2,100 nm (2.1 µm)	
Operating principle	Pulsed	
Energy	200–5,000 mJ	
Pulse duration	Adjustable (50–1,100 µs)	
Pilot beam	Green: 532 nm, < 5 mW, can be set to continuous or flashing	
Max. operating temperature	10–30 °C	
Storage temperature	Min. +5 °C, max. 40 °C	
Power supply		
Voltage	200–230 V, 50/60 Hz, < 32 A	
Frequency	3–60 Hz	
Dimensions and weights		
Dimensions (W x H x D)	595 x 1,200 x 1,074 mm	
Weight	200 kg	

IX23 || Subject to modifications. Please note that some products may not be available in all countries. Please always take note of the information that is provided with the product. For more detailed information, please consult with your contact partner or directly with Richard Wolf GmbH.

"MEGA PULSE 70⁺" LASER

2.12

MEGA Pulse⁷⁰⁺

LASER FIBERS



Sterile (Pack= 1 PC)		Core diameter						Product no.
		200 µm	200 µm	272 µm	365 µm	550 µm	800 µm	
Single use	Power laser fiber Ø 200 µm, disposable	●						487502200
	Laser fiber Ø 200 µm, disposable		●					487501200
	Laser fiber Ø 272 µm, disposable			●				487501272
	Laser fiber Ø 365 µm, disposable				●			4875013650
	Laser fiber Ø 550 µm, disposable					●		487501550
	Laser fiber Ø 800 µm, disposable						●	487501800
	Laser fiber Ø 1,000 µm, disposable							●
Multiple use	Power laser fiber Ø 200 µm, reusable	●						87502200
	Laser fiber Ø 200 µm, reusable		●					87501200
	Laser fiber Ø 272 µm, reusable			●				87501272
	Laser fiber Ø 365 µm, reusable				●			875013650
	Laser fiber Ø 550 µm, reusable					●		87501550
	Laser fiber Ø 800 µm, reusable						●	87501800
	Laser fiber Ø 1,000 µm, reusable							●

"MEGA PULSE 70+" LASER



2.12

IX23 || Subject to modifications. Please note that some products may not be available in all countries. Please always take note of the information that is provided with the product. For more detailed information, please consult with your contact partner or directly with Richard Wolf GmbH.

MEGA Pulse⁷⁰⁺

ACCESSORIES

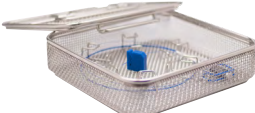
Accessories		Product no.	
Fiber-stripping forceps, autoclavable	for stripping laser fibers	Ø 200–272 µm	AGM000053
		Ø 365–400 µm	AGM000078
		Ø 550–600 µm	AGM000052
		Ø 800 µm	AGM000064
Fiber-stripping forceps	for stripping laser fibers	Ø 0.1–0.4 mm	2286527
		Ø 0.3–1.0 mm	2286523
Ceramic cutter with silicone pad		AGM000080	
Filling bottle with tube		IAM000088	
Laser protection goggles	(Also suitable for glasses-wearers)	OBM003603	
2-pedal footswitch		2030232	
Key set		2286525	
Door contact plug		2286520	
Blast shield with mounting		OAM001523	
Power cable TL 3 m		2286230	
Accessories box for MegaPulse		KBM000103	
Adapter cable	CEE coupling, 3-pin 32 A 6 h 230 V AC blue (on the device side) and CEE plug, 5-pin 32 A 6 h 400 V AC red (in-house)	100-201-0518	

Machine reprocessing		Product no.
 Perforated basket for laser fiber	Holds: Laser fiber, for machine reprocessing, sterilization (steam and low-temperature), storage, and transport; internal dimensions (W x H x D): 231 x 52 x 223 mm external dimensions (W x H x D): 248 x 72 x 239 mm	38001
Also:  Fixing ring Ø 34.6 mm	for holding instruments during machine reprocessing, sterilization (steam and low-temperature), storage, and transport, Ø 34.6 x 2.62 mm, Pack = 5 PCS	643301262

Pulvis 60⁺

60 W THULIUM FIBER LASER (TFL)

FOR STONE THERAPY AND ENDOSCOPIC ENUCLEATION OF THE PROSTATE (EEP)



		Product no.
<p>Pulvis 60⁺ 60 W thulium fiber laser (TFL)</p>	<p>PFMS00006</p>	

Pulvis 60⁺

60 W THULIUM FIBER LASER (TFL) TECHNICAL DATA

Pulvis 60 ⁺		PFMS00006	
Device properties			
Display	Fold-out, rotatable touchscreen display (rotates 90° to the right and 180° to the left)		
Operating temperature	15–30 °C (at a room temperature between 25 °C and 30 °C, operation is guaranteed with a maximum output power of up to 40 W)		
Storage/transport temperature	Min. +5 °C/max. 40 °C		
Atmospheric pressure	800–1,060 hPa		
Operating humidity	30–85 %, non-condensing		
Max. noise level	< 70.0 dB		
Equipment			
Cooling method	Air cooling system		
Power supply			
Mains + frequency	100–240 V AC, 50/60 Hz		
Power consumption	1,000 VA		
Regulatory standards			
Classification according to the Medical Devices Directive 93/42/EEC	Class IIb		
Laser classification according to IEC/EN 60825-1:2014	Class 4		
Pilot beam classification according with IEC/EN 60825-1:2014	Class 3R		
Dimensions and weights			
Weight	100 kg		
Dimensions (W x H x D)	470 x 1,156 x 810 mm 470 x 940 x 810 mm – display closed		

IX23 || Subject to modifications. Please note that some products may not be available in all countries. Please always take note of the information that is provided with the product. For more detailed information, please consult with your contact partner or directly with Richard Wolf GmbH.

Pulvis 60⁺

60 W THULIUM FIBER LASER (TFL)

TECHNICAL DATA

Pulvis 60 ⁺ PFMS00006	
Laser source specifications	
Laser type	Thulium fiber-laser
Wavelength	1,940 nm ± 20 nm
Maximum output power	60 W (pulsed/CW)
Pulse energy	0.02–6 J
Operating mode	Pulsed/CW
Pulse duration	50 µs – CW
Frequency of recurrence	1–2,500 Hz
Delivery system	Large selection of laser fibers (see next page) (sterile, disposable, and reusable)
Pilot beam	Green 532 nm (adjustable) < 5 mW, class 3R
Goggles	1940 D LB4

Pulvis 60⁺

LASER FIBERS

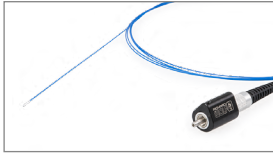



Sterile (Pack= 10 PCS)		Core diameter									Product no.
		150 µm	200 µm	272 µm	365 µm	500 µm	550 µm	600 µm	800 µm	1,000 µm	
Single use	Single use optical fiber 150 µm	●									OFJ001511
	Single use optical fiber 200 µm		●								OFJ002011
	Single use optical fiber 272 µm			●							OFJ702711
	Single use optical fiber ball tip 272 µm			●							OFJ302711
	Single use optical fiber 365 µm				●						OFJ703611
	Single use optical fiber 550 µm						●				OFJ005511
	Single use optical fiber lateral 600 µm							●			OFJ506011
	Single use optical fiber 800 µm								●		OFJ008011
	Single use optical fiber 1,000 µm									●	OFJ009911
Multiple use	Reusable 10x optical fiber 200 µm		●								OFJ002013
	Reusable 10x optical fiber 272 µm			●							OFJ702713
	Reusable 10x optical fiber 365 µm				●						OFJ703613
	Reusable 10x optical fiber 500 µm					●					OFJ005513
	Reusable 10x optical fiber 800 µm								●		OFJ008013
	Reusable 10x optical fiber 1,000 µm									●	OFJ009913

Pulvis 60⁺

ACCESSORIES

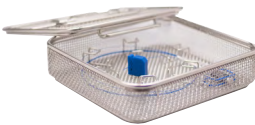
Accessories	Product no.
Interlock Conn. Medical Devices Binder	EAM000045.00
Key	MBQ000190.00
Power cord-5m-spina Shuko 16A EUR	EAM001440.00
Fiberstripper optical fibers Ø300-1000 µm	OBM001079.00
Fiberstripper optical fibers Ø100-400 µm	OBM001080.00
Case salsa 1650 no brand accessories	KBM000103.01
Ceramic fiber cutter with slipcase	AGM000080.00
Goggle protection f18.P1d09.1003	OBM003778.00
Optical blast shield for ffl ext-access	OAM002112.00

Machine reprocessing	Product no.
 <p>Perforated basket for laser fiber</p>	<p>Holds: Laser fiber, for machine reprocessing, sterilization (steam and low-temperature), storage, and transport; internal dimensions (W x H x D): 231 x 52 x 223 mm external dimensions (W x H x D): 248 x 72 x 239 mm</p> <p>38001</p>
<p>Also:</p>  <p>Fixing ring Ø 34.6 mm</p>	<p>for holding instruments during machine reprocessing, sterilization (steam and low-temperature), storage, and transport, Ø 34.6 x 2.62 mm, Pack = 5 PCS</p> <p>643301262</p>

FLUID CONTROL 2225

SUCTION IRRIGATION PUMP

core



	Product no.
<p>FLUID CONTROL 2225 Irrigation pump for HYS/URO/LAP bndI consisting of: Irrigation pump for HYS/URO/LAP (2225001) and power cable 3 m long (2440.03)</p>	22250011
Also:	
<p>Balancing module for hysteroscopy and endourology, fluid management for fluid balancing in combination with FLUID CONTROL 2225, mobile stand with integrated weighing cells and space for up to 4 irrigation fluid bags</p>	2225023

Mini PCNL or standard PCNL

- Pressure and flow-controlled indication
 Simultaneous monitoring of nominal pressure and irrigation flow
- Integrated vacuum function
 Rapid fluid replacement for optimum viewing conditions

Accessories		Product no.
Footswitch	Only for use in urology and within the indication TUR/enucleation, possibility of short-term increase in pressure if visibility is poor (Flush function)	2204901

IX23 | Subject to modifications. Please note that some products may not be available in all countries. Please always take note of the information that is provided with the product. For more detailed information, please consult with your contact partner or directly with Richard Wolf GmbH.

FLUID CONTROL 2225

2.14

FLUID CONTROL 2225

SUCTION IRRIGATION TUBE SETS

Irrigation			Product no.
Accessories – reusable	Tube set with piercing spike	with Luer-Lock connection, autoclavable, incl. 10 spare membranes, reusable for 20 reprocessing cycles	8171223
Accessories – disposable	Irrigation tube set with piercing spike, L 3 m	(PACK= 10 PCS), with Luer-Lock connection, sterile, disposable product	4171223
	Tube set with CARE-LOCK, L 3 m	(PACK= 10 PCS), sterile, disposable product	4171224
	Suction irrigation tube set	(PACK= 10 PCS), with piercing spike, sterile disposable product, PVC	4171225

Suction			Product no.
Accessories – reusable	Tube set for vacuum, incl. filter	with integrated hygiene filter, PACK= 10 PCS, service life: 30 days (connected to irrigation pump)	2206207
	Irrigation tube	L 1.2 m, with Luer-Lock, for suction irrigation handle 8385.901 and tube set 8171223 or 8170.223	817123
	Suction tube L 3 m	for suction irrigation handle 8385.901	8171402
	Secretion container, 2 l	2 liters, without cover	8170.6551
	Cover	for secretion trap 8170.6551, reusable	8170.6552
Accessories – disposable	Secretion container, 2.5 l	2.5 liters	41706566
	Secretion container bndl consisting of:	Secretion container 2.5 l (41706566) and secretion bag (PACK= 90 PCS) (41706564)	4170657
	Tube set for suction (2 connections)	sterile, disposable product, (PACK= 10 PCS) for connecting instruments to collecting container	T0503-01
	Angled 90° plug-in coupling	(PACK= 10 PCS) For connecting vacuum tube 2206207 to disposable container systems	0771019

FLUID CONTROL 2225

CABLE ACCESSORIES

		Product no.
Patch cable, RJ45 SFTP, 0.5 m	Cable length 0.5 m	72325378
Patch cable, RJ45 HRS TM11, 1.0 m	Cable length 1.0 m	72325429
Patch cable, RJ45 S/FTP CAT.6 10 m	Cable length 10 m	72325434
Plastic caps for network socket	(Pack = 8 PCS)	5592105
Power cable	Cable length 3 m	2440.03

IX23 || Subject to modifications. Please note that some products may not be available in all countries. Please always take note of the information that is provided with the product. For more detailed information, please consult with your contact partner or directly with Richard Wolf GmbH.

TECHNICAL DATA

FLUID CONTROL 2225

FLUID CONTROL 2225		2225001
Device properties		
Operating conditions		+10 °C to +40 °C, 30 % to 75 % rel. humidity, 70 to 106 kPa atmospheric pressure 3,000 m max. altitude above sea level
Storage and transport conditions		-20 °C to +60 °C, 10 % to 90 % rel. humidity, 70 to 106 kPa atmospheric pressure
Power supply		
Mains + frequency		100–240 V AC, 50/60 Hz
Power consumption	100 V/60 Hz	110 VA
	240 V/50 Hz	120 VA
Current consumption	100 V/60 Hz	1.10 A
	240 V/50 Hz	0.50 A
Fuse		T 3.15 AH, 250 V
Regulatory standards		
Protection class (I, II)		I
Electromagnetic compatibility (EMC)		EN 60601-1/IEC 60601-1 EN 60601-1-2/IEC 60601-1-2
Medical Devices Directive 93/42/EEC		Class IIb
Housing protection rating (IP code)		IP 21
Protection against electric shock		Type BF applied part
Degree of protection in the presence of flammable mixtures		Device is not protected against explosions (do not operate this device in explosive atmospheres)
Maximum suction vacuum		-60 kPa
Dimensions and weights		
Weight		8.8 kg
Dimensions (W x H x D)		300 mm x 157 mm x 436 mm
Relevant application parameters		
Nominal flow range		Hysteroscopy: 800 ml/min (max. flow, not adjustable) Endourology: 10–800 ml/min (max. flow) Laparoscopy: 0.1–1.8 l/min (max. flow)
Suction power		Max. 2 l/min
Starting nominal pressure range		Hysteroscopy: 15–200 mmHg Endourology: 15–90 mmHg/20–120 cmH2O Laparoscopy: 300 mmHg (not adjustable)
Pressure		0–300 mmHg
Deficit		-9,990 to +9,990 ml/0 to 99.9 l

TECHNICAL DATA

FLUID CONTROL 2225

Balancing module		2225023
Device properties		
Operating conditions	+10 °C to +40 °C, 30 % to 75 % rel. humidity, 70 to 106 kPa atmospheric pressure 3,000 m max. altitude above sea level	
Storage and transport conditions	-20 °C to +60 °C, 10 % to 90 % rel. humidity, 70 to 106 kPa atmospheric pressure	
Regulatory standards		
Electromagnetic compatibility (EMC)	EN 60601-1/IEC 60601-1 EN 60601-1-2/IEC 60601-1-2	
Housing protection rating (IP code)	IP 21	
Maximum load of container scale	16 kg/4 containers of 3 l each	
Maximum load of bag scale	23 kg/4 bags of 5 l each	
Dimensions and weights		
Weight	15.4 kg	
Dimensions (W x H x D)	618 mm x 1,064 mm x 618 mm	

Footswitch		2204901
Power supply		
Power supply connection	Max. 24 V	
Power consumption	Max. 0.1 A	
Regulatory standards		
Electromagnetic compatibility (EMC)	EN 60601-1/IEC 60601-1	
Housing protection rating (IP code)	IP X8	
Plug	7-pin circular connector	
Cable length	4.5 m	
Dimensions and weights		
Weight	300 g	
Dimensions (W x H x D)	66 mm x 27 mm x 91 mm	

IX23 | Subject to modifications. Please note that some products may not be available in all countries. Please always take note of the information that is provided with the product. For more detailed information, please consult with your contact partner or directly with Richard Wolf GmbH.



PEDIATRIC UROLOGY

PEDIATRIC UROLOGY

-
- 3.1 OPTICAL URETHROTOME FOR NEWBORNS AND INFANTS
-
- 3.2 CYSTO-URETHROSCOPE 8686 FOR NEWBORNS AND INFANTS
-
- 3.3 CYSTO-URETHROSCOPE 8672 FOR INFANTS
-
- 3.4 MIDI-SIZE CYSTO-URETHROSCOPE FOR SMALL ANATOMIES
-
- 3.5 CYSTOSCOPE 4.5/6.5 Fr FOR NEWBORNS AND INFANTS
-
- 3.6 CYSTOSCOPE 8/9.8 Fr FOR REFLUX THERAPY IN INFANTS
-
- 3.7 RESECTOSCOPES FOR NEWBORNS AND INFANTS
-
- 3.8 MIDI-SIZE RESECTOSCOPE
-
- 3.9 ULTRA-THIN FIBER URETERORENOSCOPE
-

E-line

OPTICAL URETHROTOME

FOR TELESCOPE 1.9 MM

FOR NEWBORNS AND INFANTS

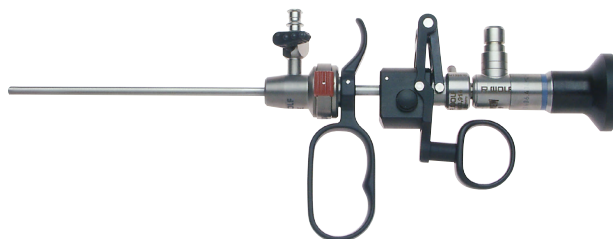

12 o'clock cutting position

AUTOGLAVE
134° C / 273° F

Sheath for cystoscope bndl	consisting of:	Fr	Capacity in Fr	Color coding	Product no.
Sheath for urethrotome 8.5 Fr with irrigation valve	Sheath for urethrotome 8.5 Fr (8693.0145), obturator for urethrotome 8.5 Fr (8693.0147), tube with LUER-LOCK connector (886.00)	8.5	3	Red	8693.0141

Also: individual sheaths and obturators





Individual sheath and obturator	SL/WL	Color coding	Product no.	Adapter for resectoscope	Working element for urethrotome passive 0°
Sheath for urethrotome 8.5 Fr	SL 105 mm	Red	8693.0145	for diagnostics and probing 8688.264	Receptacle for stricture scalpels 8693.914
Obturator for urethrotome 8.5 Fr	WL 123 mm	Red	8693.0147		

Also:



PANOVIEW telescope	Direction of view	Ø	WL	TL	Product no.
Telescope 0° Ø 1.9 mm WL 178 mm	0°	1.9 mm	178 mm	243 mm	8686.414



Stricture scalpels	Cutting edge	Product no.
 Scalpel 9 Fr ceramic, semi-circular	Semi-circular	8693.961
 Scalpel 8.5 Fr, sickle-shaped	Sickle-shaped	8693.93
 Scalpel 8.5 Fr, hook-shaped	Hook-shaped	8688.94

Recommended accessories	Product no.
Perforated basket for standard telescope 1	Internal dimensions (W x H x D): 270 x 52 x 40 mm External dimensions (W x H x D): 297 x 54 x 59 mm 38015
Fiber light cable bndl consisting of: Fiber light cable (80662523), projector-side adapter (8095.07), and endoscope-side adapter (809509)	Ø 2.5 mm, 2.3 m long 806625231

E-line

CYSTO-URETHROSCOPE 8686

FOR TELESCOPE 1.9 MM

FOR NEWBORNS AND INFANTS

CYSTO-URETHROSCOPE 8686

3.2



AUTOCLAVE
134° C / 273° F

Sheath for cystoscope bndl	consisting of:	Fr	Color coding	Capacity	Product no.
Sheath for cystoscope 7.5 Fr with 2 irrigation valves	Sheath for cystoscope 7.5 Fr (8686.0145), obturator for cystoscope 7.5 Fr (8686.0147)	7.5	Blue	-	8686.0141
Sheath for cystoscope 8.5 Fr with 2 irrigation valves and 1 instrument port	Sheath for cystoscope 8.5 Fr (8686.0245), obturator for cystoscope 8.5 Fr (8686.0247)	8.5	Red	3 Fr	8686.0241
Sheath for cystoscope 9.5 Fr with 2 irrigation valves and 1 instrument port	Sheath for cystoscope 9.5 Fr (8686.0345), obturator for cystoscope 9.5 Fr (8686.0347)	9.5	Yellow	4 Fr	8686.0341

Also: individual sheaths and obturators

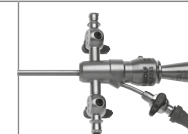
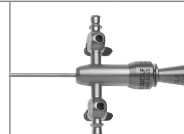

Individual sheath and obturator	SL/WL	Color coding	Product no.	Only for diagnostics (can only be used with telescope 0°)	1 instrument port
Sheath for cystoscope 7.5 Fr	SL 146 mm	Blue	8686.0145	•	
Obturator for cystoscope 7.5 Fr	SL 183 mm	Blue	8686.0147		
Sheath for cystoscope 8.5 Fr	SL 145 mm	Red	8686.0245		•
Obturator for cystoscope 8.5 Fr	WL 180 mm	Red	8686.0247		
Sheath for cystoscope 9.5 Fr	SL 145 mm	Yellow	8686.0345		•
Obturator for cystoscope 9.5 Fr	WL 180 mm	Yellow	8686.0347		

Also:



PANOVIEW telescope	Direction of view	Ø	WL	TL	Product no.
Telescope 0° Ø 1.9 mm WL 178 mm	0°	1.9 mm	178 mm	243 mm	8686.414
Telescope 30° Ø 1.9 mm WL 179 mm	30°	1.9 mm	179 mm	241 mm	8686.415

Recommended accessories	Product no.
Perforated basket for standard telescope 2	Internal dimensions (W x H x D): 454 x 52 x 40 mm External dimensions (W x H x D): 481 x 54 x 59 mm 38016
Fiber light cable bndl consisting of: Fiber light cable (80662523), projector-side adapter (8095.07), and endoscope-side adapter (809509)	Ø 2.5 mm, 2.3 m long 806625231

IX23 | Subject to modifications. Please note that some products may not be available in all countries. Please always take note of the information that is provided with the product. For more detailed information, please consult with your contact partner or directly with Richard Wolf GmbH.

E-line

CYSTO-URETHROSCOPE 8672

FOR TELESCOPE 2.7 MM
FOR INFANTS

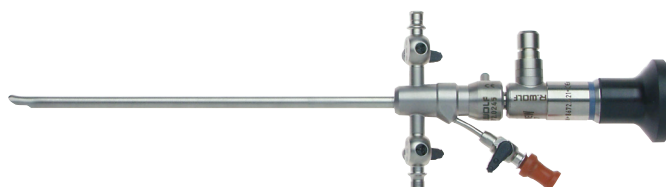

AUTOCLAVE
134° C / 273° F

Sheath for cystoscope bndl	consisting of:	Fr	Color coding	Capacity	Product no.
Sheath for cystoscope 11 Fr with 2 irrigation valves	Sheath for cystoscope 11 Fr (8672.0145), obturator for cystoscope 11 Fr (8672.0147), tube with LUER-LOCK connector (886.00)	11	Red	-	8672.0141
Sheath for cystoscope 12 Fr with 2 irrigation valves and 1 instrument port	Sheath for cystoscope 12 Fr (8672.0245), obturator for cystoscope 12 Fr (8686.0247), tube with LUER-LOCK connector (886.00), "RIVO" rubber cap, red-orange (15220.006)	12	Green	3 Fr	8672.0241
Sheath for cystoscope 13 Fr with 2 irrigation valves and 2 instrument ports	Sheath for cystoscope 13 Fr (8686.0345), obturator for cystoscope 13 Fr (8686.0347), tube with LUER-LOCK connector (886.00), "RIVO" rubber cap, red-orange (15220.004), "RIVO" rubber cap, red-orange (15220.006)	13	Blue	4 Fr	8672.0341

Also: individual sheaths and obturators						
Individual sheath and obturator	SL/WL	Color coding	Product no.	Only for diagnostics	1 instrument port	2 instrument ports
Sheath for cystoscope 11 Fr	SL 149 mm	Red	8672.0145	●		
Obturator for cystoscope 11 Fr	WL 184 mm	Red	8672.0147			
Sheath for cystoscope 12 Fr	SL 150 mm	Green	8672.0245		●	
Obturator for cystoscope 12 Fr	WL 184 mm	Green	8672.0247			
Sheath for cystoscope 13 Fr	SL 149 mm	Blue	8672.0345			●
Obturator for cystoscope 13 Fr	WL 184 mm	Blue	8672.0347			

Also:						
PANOVIEW telescope	Direction of view	Ø	WL	TL	Product no.	
Telescope 0° Ø 2.7 mm WL 182 mm	0°	2.7 mm	182 mm	249 mm	8672.421	
Telescope 30° Ø 2.7 mm WL 182 mm	30°	2.7 mm	182 mm	247 mm	8672.422	
Telescope 70° Ø 2.7 mm WL 185 mm	70°	2.7 mm	185 mm	247 mm	8672.425	

Recommended accessories		Product no.
Perforated basket for standard telescope 2	Internal dimensions (W x H x D): 454 x 52 x 40 mm External dimensions (W x H x D): 481 x 54 x 59 mm	38016
Fiber light cable bndl consisting of: Fiber light cable (80662523), projector-side adapter (8095.07), and endoscope-side adapter (809509)	Ø 2.5 mm, 2.3 m long	806625231

CYSTO-URETHROSCOPE 8672

3.3



IX23 || Subject to modifications. Please note that some products may not be available in all countries. Please always take note of the information that is provided with the product: for more detailed information, please consult with your contact partner or directly with Richard Wolf GmbH.

E-line

CYSTO-URETHROSCOPE 8672

FOR TELESCOPE 2.7 MM
FOR INFANTS

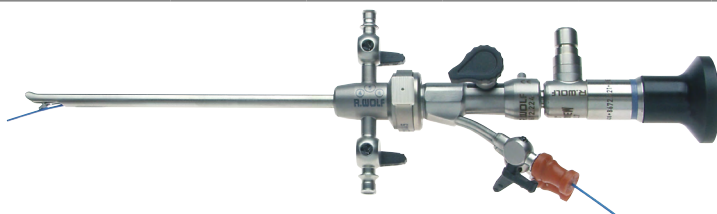

AUTOCLAVE
134° C / 273° F

Sheath for cystoscope bndl	consisting of:	Fr	Color coding	Product no.
Sheath for cystoscope 14 Fr with 2 irrigation valves	Sheath for cystoscope 14 Fr (8672.0445), obturator for cystoscope 14 Fr (8672.0447), tube with LUER-LOCK connector (886.00)	14	White	8672.0441

Also: individual sheaths and obturators

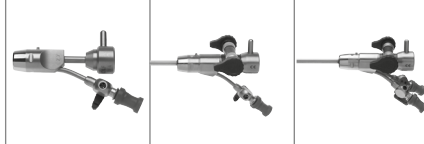

Individual sheath and obturator	SL/WL	Color coding	Capacity in Fr	Product no.	Adapter for cystoscope	Working insert for cystoscope 0/30/70 with Albarrán lever	
						1 instrument port	2 instrument ports
Sheath for cystoscope 14 Fr	SL 119 mm	White	5	8672.0445	for urethroscopy 8672.264	for cystoscopy 8672.214	
			2 x 4				for cystoscopy 8672.224
Obturator for cystoscope 14 Fr	WL 137 mm	White		8672.0447			

Also:



PANOVIEW telescope	Direction of view	Ø	WL	TL	Product no.
Telescope 0° Ø 2.7 mm WL 182 mm	0°	2.7 mm	182 mm	249 mm	8672.421
Telescope 30° Ø 2.7 mm WL 182 mm	30°	2.7 mm	182 mm	247 mm	8672.422
Telescope 70° Ø 2.7 mm WL 185 mm	70°	2.7 mm	185 mm	247 mm	8672.425

Recommended accessories	Product no.
Perforated basket for standard telescope 2	38016
Fiber light cable bndl consisting of: Fiber light cable (80662523), projector-side adapter (8095.07), and endoscope-side adapter (809509)	806625231



IX23 | Subject to modifications. Please note that some products may not be available in all countries. Please always take note of the information that is provided with the product. For more detailed information, please consult with your contact partner or directly with Richard Wolf GmbH.

E-line

OPTICAL FORCEPS

FOR CYSTO-URETHROSCOPE 8672



for use with the 0° telescope 8672.421 in sheath 8672.0441		Suitable for sheaths from	Product no.
 <p>Opt. biopsy forceps, spoon-shaped</p>	Opening on both sides, through-cutting, for taking of biopsies	14 Fr	8672.604
 <p>Opt. grasping forceps, pike-mouth jaws</p>	Opening on both sides, for grasping foreign bodies	14 Fr	8672.654

CYSTO-URETHROSCOPE 8672
3.3

IX23 || Subject to modifications. Please note that some products may not be available in all countries. Please always take note of the information that is provided with the product. For more detailed information, please consult with your contact partner or directly with Richard Wolf GmbH.



FORCEPS AND SCISSORS

SMALL MODULAR SYSTEM **HySafe**

FOR CYSTO-URETHROSCOPE 8672

CYSTO-URETHROSCOPE 8672

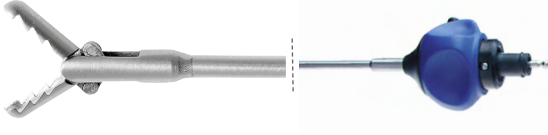

3.3

Grasping forceps jaw insert with sheath				Handle with overload protection	Complete instrument
					<ul style="list-style-type: none"> • Jaw section • Handle
	Product no.	Fr	WL	8083.001	Product no.
Grasping forceps bndl Distal angled with pike-mouth jaws	8642.6508	5	340 mm	•	8642.6502
	8645.6508	7	325 mm	•	8645.6502
Grasping forceps bndl - Spoon	8642.6008	5	340 mm	•	8642.6002
	8645.6008	7	340 mm	•	8645.6002
Biopsy forceps bndl	8642.6318	5	340 mm	•	8642.6312
Scissors bndl	8642.6818	5	340 mm	•	8642.6812
Hook scissors bndl Through-cutting	8992.6408	7	310 mm	•	8992.6402

- Can be flushed through – optimum internal cleaning
- Easy-Click – quick and simple assembly
- Overload protection – significantly longer service life

IX23 || Subject to modifications. Please note that some products may not be available in all countries. Please always take note of the information that is provided with the product. For more detailed information, please consult with your contact partner or directly with Richard Wolf GmbH.

FLEXIBLE GRASPING FORCEPS FOR CYSTO-URETHROSCOPES 8672 AND 8686

				
	Fr	WL	TL	Product no.
 Flex. scissors 4 Fr WL 230 mm with overload protection	4	230 mm	350 mm	828.244

MIDI-SIZE

CYSTO-URETHROSCOPE

for smaller anatomies
Rösch



AUTOCLAVE
134° C / 273° F

Sheath for cystoscope bndl	consisting of:	Fr	Capacity in Fr	Color coding	Product no.
Sheath for cystoscope 12.5 Fr with 2 irrigation valves	Sheath for cystoscope 12.5 Fr (86720255), obturator for cystoscope 12.5 Fr (86720257), tube with LUER-LOCK connector (886.00)	12.5	5	Green	86720251
Sheath for cystoscope 14.5 Fr with 2 irrigation valves	Sheath for cystoscope 14.5 Fr (86720455), obturator for cystoscope 14.5 Fr (86720457), tube with LUER-LOCK connector (886.00)	12	7	Green	86720451

Also: individual sheaths and obturators



Individual sheath and obturator	SL/WL	Color coding	Product no.	Adapter for cystoscope TL 65 mm
Sheath for cystoscope 12.5 Fr	SL 193 mm	Green	86720255	8672265
Obturator for cystoscope 12.5 Fr	WL 211 mm	Green	86720257	
Sheath for cystoscope 14.5 Fr	SL 194 mm	White	86720455	
Obturator for cystoscope 14.5 Fr	WL 211 mm	White	86720457	

Also:





PANOVIEW telescope	Ø	WL	TL	Product no.
Telescope 30° Ø 2.7 mm WL 267 mm	2.7 mm	267 mm	331 mm	8672432



Recommended accessories	Product no.
Perforated basket for standard telescope 2	Internal dimensions (W x H x D): 454 x 52 x 40 mm External dimensions (W x H x D): 481 x 54 x 59 mm 38016
Fiber light cable bndl consisting of: Fiber light cable (80662523), projector-side adapter (8095.07), and endoscope-side adapter (809509)	Ø 2.5 mm, 2.3 m long 806625231
HF connection cable	see UR0103/104

IX23 | Subject to modifications. Please note that some products may not be available in all countries. Please always take note of the information that is provided with the product. For more detailed information, please consult with your contact partner or directly with Richard Wolf GmbH.

FLEXIBLE AUXILIARY INSTRUMENTS FOR **MIDI-SIZE**

		Outer Ø	WL	TL	Product no.
	Flex. biopsy forceps 5 Fr WL 315 mm	5 Fr	315 mm	465 mm	829.05
	Flex. biopsy forceps 7 Fr WL 375 mm	7 Fr	375 mm	490 mm	829.07
	Flex. grasping forceps 5 Fr WL 315 mm	5 Fr	315 mm	465 mm	828.05
	Flex. grasping forceps 7 Fr WL 365 mm	7 Fr	365 mm	515 mm	828.07
	Flex. scissors 7 Fr WL 375 mm	7 Fr	375 mm	490 mm	830.07



CYSTOSCOPE 4.5/6.5 Fr

FOR NEWBORNS AND INFANTS



Optional
4712348

AUTOGLAVE
134° C / 273° F

	Direction of view	Working channel	WL	Product no.
Cystoscope bndl consisting of: Cystoscope 5° 4.5/6.5 Fr WL 120 mm (8715.401), seal Ø 7.5 mm (Pack = 10 PCS) (89.101), membrane holder (15256.393), and "RIWO" rubber cap, red-orange (15220.005)	5°	3.3 Fr	120 mm	87154012
Also:				
	Flex. grasping forceps 3 Fr WL 230 mm Fine tothing		230 mm	828.03
	Flex. biopsy forceps 3 Fr WL 230 mm		230 mm	829.03
	for inserting auxiliary instruments of 1–6 Fr: universal sealing valve 1–6 Fr, sterile (Pack = 5 PCS)			4712348

Recommended accessories		Product no.
Perforated basket for cystoscope/telescope 	Internal dimensions (W x H x D): 451 x 65 x 124 mm External dimensions (W x H x D): 467 x 75 x 132 mm	38004
Fiber light cable bndl consisting of: Fiber light cable (80662523), projector-side adapter (8095.07), and endoscope-side adapter (809509)	Ø 2.5 mm, 2.3 m long	806625231

IX23 || Subject to modifications. Please note that some products may not be available in all countries. Please always take note of the information that is provided with the product. For more detailed information, please consult with your contact partner or directly with Richard Wolf GmbH.



CYSTOSCOPE 4.5/6.5 Fr

3.5

CYSTOSCOPE 8/9.8 Fr

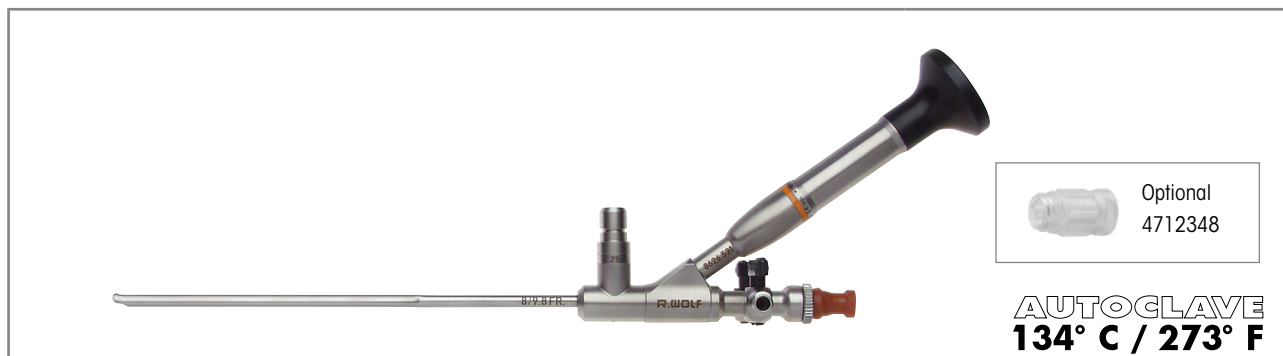
FOR REFLUX THERAPY IN INFANTS

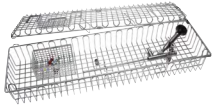

	Direction of view	Working channel	WL	Product no.
Cystoscope 12° 8.0/9.8 Fr WL 150 mm	12°	5 Fr	150 mm	8626.531
Also:				
	Rigid grasping forceps 5 Fr WL 340 mm Fine toothing, for splint removal		340 mm	8626.65
	Coag. electrode mono 5 Fr WL 400 mm		400 mm	823.05
	for inserting auxiliary instruments of 1–6 Fr: universal sealing valve 1–6 Fr, sterile (Pack = 5 PCS)			4712348

Recommended accessories		Product no.
	Internal dimensions (W x H x D): 451 x 65 x 124 mm External dimensions (W x H x D): 467 x 75 x 132 mm	38004
Fiber light cable bndl consisting of: Fiber light cable (80662523), projector-side adapter (8095.07), and endoscope-side adapter (809509)	Ø 2.5 mm, 2.3 m long	806625231

CYSTOSCOPE 8/9.8 Fr

3.6

E-line

RESECTOSCOPE



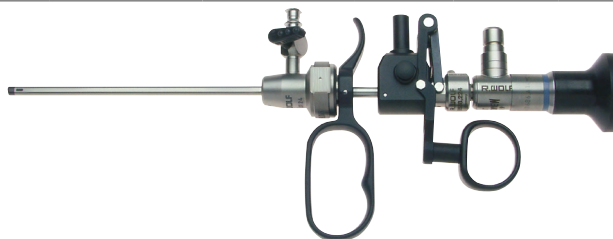

FOR TELESCOPE 1.9 MM

FOR NEWBORNS AND INFANTS



6 o'clock cutting position

AUTOCLAVE
134° C / 273° F

Sheath for cystoscope bndl	consisting of:	Fr	Capacity in Fr	Color coding	Product no.
Sheath for resectoscope 9 Fr with irrigation valve	Sheath for resectoscope 9 Fr (8688.0145), obturator for resectoscope 9 Fr (8688.0147), tube with LUER-LOCK connector (886.00)	9	3	White	8688.0141
Also: individual sheaths and obturators					
					
Individual sheath and obturator	SL/WL	Color coding	Product no.	Adapter for resecto- scope	Working element, passive, mono 30°
Sheath for resectoscope 9 Fr	SL 106 mm	White	8688.0145	for diagnostics and probing	Receptacle for stricture scalpels
Obturator for resectoscope 9 Fr	WL 123 mm	White	8688.0147	8688.264	8688.224
Also: 					
PANOVIEW telescope	Direction of view	Ø	WL	TL	Product no.
Telescope 0° Ø 1.9 mm WL 178 mm	0°	1.9 mm	178 mm	243 mm	8686.414



Recommended accessories	Product no.
Perforated basket for standard telescope 1	Internal dimensions (W x H x D): 270 x 52 x 40 mm External dimensions (W x H x D): 297 x 54 x 59 mm 38015
Fiber light cable bndl consisting of: Fiber light cable (80662523), projector-side adapter (8095.07), and endoscope-side adapter (809509)	Ø 2.5 mm, 2.3 m long 806625231
Electrodes and scalpels	see URO182
HF connection cable	see URO103/104

IX23 || Subject to modifications. Please note that some products may not be available in all countries. Please always take note of the information that is provided with the product. For more detailed information, please consult with your contact partner or directly with Richard Wolf GmbH.

E-line

RESECTOSCOPE





FOR TELESCOPE 2.7 MM

FOR NEWBORNS AND INFANTS



6 o'clock cutting position

AUTOCLAVE
134° C / 273° F

Sheath for cystoscope bndl	consisting of:			Fr	Color coding	Product no.	
Sheath for resectoscope 11.5 Fr with irrigation valve	Sheath for resectoscope 11.5 Fr (8677.0145), obturator for resectoscope 11.5 Fr (8677.0147), tube with LUER-LOCK connector (886.00)			11.5	Yellow	8677.0141	
Also: individual sheaths and obturators							
							
Individual sheath and obturator	SL/WL	Color coding	Product no.	Adapter for urethrotome/ resectoscope	Working element, active, mono 0°		
Sheath for resectoscope 11.5 Fr	SL 105 mm	Yellow	8677.0145	for diagnostics (without stopcock)	Receptacle for stricture scalpels		
Obturator for resectoscope 11.5 Fr	WL 124 mm	Yellow	8677.0147	8677.254	8677.224		
Also: 							
PANOVIEW telescope				Ø	WL	TL	Product no.
Telescope 0° Ø 2.7 mm WL 182 mm				2.7 mm	182 mm	249 mm	8672.421







RESECTOSCOPES
3.7



Recommended accessories		Product no.
Perforated basket for standard telescope 1	Internal dimensions (W x H x D): 270 x 52 x 40 mm External dimensions (W x H x D): 297 x 54 x 59 mm	38015
Fiber light cable bndl consisting of: Fiber light cable (80662523), projector-side adapter (8095.07), and endoscope-side adapter (809509)	Ø 2.5 mm, 2.3 m long	806625231
Electrodes and scalpels		see URO182
HF connection cable		see URO103/104

IX23 || Subject to modifications. Please note that some products may not be available in all countries. Please always take note of the information that is provided with the product. For more detailed information, please consult with your contact partner or directly with Richard Wolf GmbH.

ELECTRODES AND SCALPELS

FOR RESECTOSCOPE WITH TELESCOPE 1.9 MM AND 2.7 MM

Electrodes		for resectoscope with telescope		
		Loop	1.9 mm	2.7 mm
	Cutting electrode mono 9 Fr 0°	Round	8688.93	
	Cutting electrode mono 11.5 Fr 0°			8416.03
	Coag. electrode mono 9 Fr 0°	Ball	8688.91	
	Coag. electrode mono 11.5 Fr 0°			8416.01
	Hook electrode mono 9 Fr 0°	Hook	8688.95	
	Hook electrode mono 11.5 Fr 0°			8416.09
	Coag. electrode mono 9 Fr 0° 90° angled retrograde	Ball	8688.994	

Scalpel, for cold cutting of urethral strictures		for resectoscope with telescope		
		Cutting edge	1.9 mm	2.7 mm
	Scalpel 9 Fr ceramic, semi-circular	Semi-circular	8693.961	
	Scalpel 11.5 Fr ceramic, semi-circular			8677.961
	Scalpel 8.5 Fr, sickle-shaped	Sickle-shaped	8693.93	
	Scalpel 11.5 Fr, sickle-shaped			8677.93
	Scalpel 8.5 Fr, hook-shaped	Hook-shaped	8688.94	

IX23 | Subject to modifications. Please note that some products may not be available in all countries. Please always take note of the information that is provided with the product. For more detailed information, please consult with your contact partner or directly with Richard Wolf GmbH.

MIDI-SIZE RESECTOSCOPE

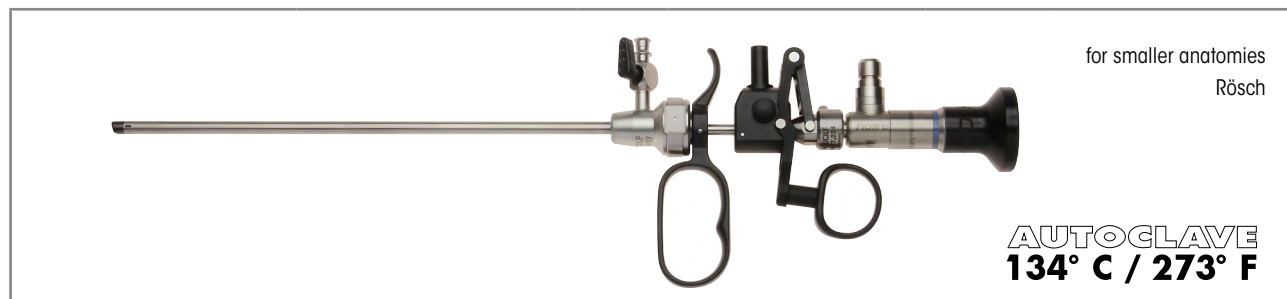

	consisting of:	Product no.
Sheath for resectoscope 14.5 Fr with irrigation valve	Sheath for resectoscope 14.5 Fr (86770155), obturator for resectoscope 14.5 Fr (86770157), tube with LUER-LOCK connector (886.00)	86770151

Also: individual sheaths and obturators



Individual sheath and obturator	SL/WL	Color coding	Product no.	Working element, active, mono 0°
Sheath for resectoscope 14.5 Fr	SL 221 mm	White	86770155	8677.224
Obturator for resectoscope 14.5 Fr	WL 240 mm	White	86770157	

Also:



PANOVIEW telescope	Ø	WL	TL	Product no.
Telescope 0° Ø 2.7 mm WL 267 mm	2.7 mm	267 mm	334 mm	8672430



Recommended accessories	Product no.
Perforated basket for standard telescope 2	Internal dimensions (W x H x D): 454 x 52 x 40 mm External dimensions (W x H x D): 481 x 54 x 59 mm 38016
Fiber light cable bndI consisting of: Fiber light cable (80662523), projector-side adapter (8095.07), and endoscope-side adapter (809509)	Ø 2.5 mm, 2.3 m long 806625231
Container (W x H x D) 300 x 60 x 200 mm	33020
Monopolar connection cable	see URO103/104



MIDI-SIZE RESECTOSCOPE



3.8

IX23 || Subject to modifications. Please note that some products may not be available in all countries. Please always take note of the information that is provided with the product. For more detailed information, please consult with your contact partner or directly with Richard Wolf GmbH.

MIDI-SIZE

AUXILIARY INSTRUMENTS FOR THE MIDI-SIZE RESECTOSCOPE

Stricture scalpels with ceramic cutter		Cutting surface	Product no.
	Scalpel 14.5 Fr, lancet-shaped	Lancet-shaped, cuts on both sides	8677981
	Scalpel 14.5 Fr, sickle-shaped	Sickle-shaped	8677931

Electrodes		Electrode shape	Product no.
	Coag. electrode mono 14.5 Fr 0° Stem color yellow	Button	8416011
	Cutting electrode mono 14.5 Fr 0° Stem color yellow	Round loop	8416031
	Hook electrode mono 14.5 Fr 0° Stem color yellow	Hook	8416091

E-line



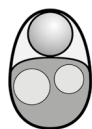

ULTRA-THIN FIBER URETERORENOSCOPE

WITH LATERAL EYEPIECE

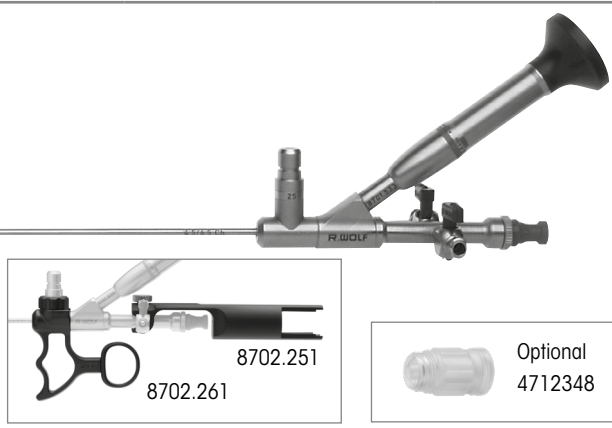

AUTOCLAVE
134° C / 273° F



	WL	TL	Direction of view	Fr	Working channel	Product no.
Ureterorenoscope 5° 4.5/6.5 Fr WL 430 mm Atraumatically shaped tip	430 mm	555 mm	5°	4.5/6.5 Fr	3 Fr	8701.534
Recommended accessories						Product no.
	Flex. grasping forceps 3 Fr WL 530 mm					828.605
	Flex. biopsy forceps 3 Fr WL 530 mm					829.603
	Laser fiber Ø 200 µm, disposable					487501200
	Laser fiber Ø 272 µm, disposable					487501272
	Laser fiber Ø 200 µm, reusable					87501200
	Laser fiber Ø 272 µm, reusable					87501272
Handle for E-Line ureterorenoscopes						8702.261
Guide element for ureterorenoscope for LITHOCLAST handpieces						8702.251
for inserting auxiliary instruments of 1–6 Fr: universal sealing valve 1–6 Fr, sterile (Pack = 5 PCS)						4712348
Membrane holder standard						15256.393
Membrane holder with Luer						15256.456
Seal Ø 7.5 mm (Pack = 10 pcs)						89.101
LithoClast probe Ø 0.8 mm WL 605 mm						8742.001
Perforated basket, upper urinary tract 1 with small part basket			Internal dimensions (W x H x D): 619 x 65 x 124 mm External dimensions (W x H x D): 635 x 75 x 132 mm			38003
Marking pen, black						38201.948
Fiber light cable bndl consisting of: Fiber light cable (80662523), projector-side adapter (8095.07), and endoscope-side adapter (809509)			Ø 2.5 mm, 2.3 m long			806625231
Auxiliary instruments						see UR0197

FIBER URETERORENOSCOPE

3.9

IX23 || Subject to modifications. Please note that some products may not be available in all countries. Please always take note of the information that is provided with the product. For more detailed information, please consult with your contact partner or directly with Richard Wolf GmbH.



AUXILIARY INSTRUMENTS

AUXILIARY INSTRUMENTS

4.1

BLADDER SYRINGES

4.2

SEALING CAPS

4.3

**LUER-LOCK PARTS / STOPCOCKS AND IRRIGATION ADAPTERS /
SEALING VALVE / ADAPTER / LASER ADJUSTMENT UNIT**

4.4

FORCEPS AND SCISSORS, RIGID

4.5

FORCEPS AND SCISSORS, FLEXIBLE

4.6

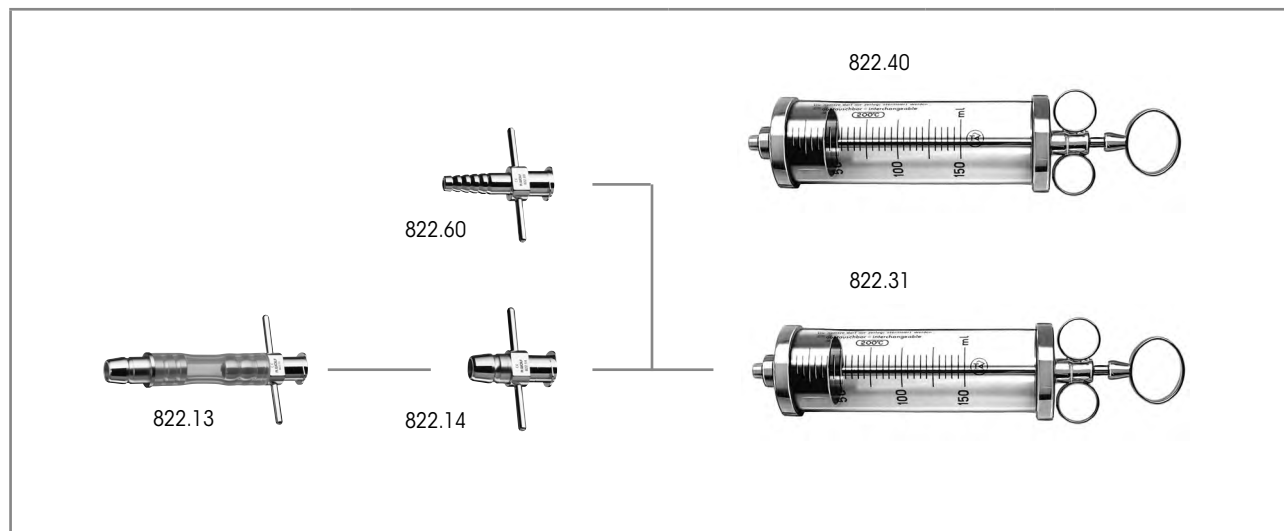

ELECTRODES

BLADDER SYRINGES





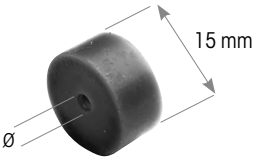
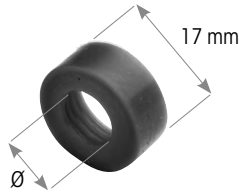







		Ø	ml	L/TL	Product no.
Bladder syringe 150 ml Ø 54 mm	for flexible and rigid adapters	54 mm	150 ml	L 248 mm	822.31
Flexible adapter for bladder syringe	Compatible with bladder syringe 822.31			TL 106 mm	822.13
Rigid adapter for bladder syringe	Compatible with instruments with cone B and bladder syringe 822.31			TL 37 mm	822.14
Bladder syringe 150 ml Ø 54 mm		54 mm	150 ml	L 248 mm	822.40
Rigid adapter for bladder syringe	Compatible with bladder syringe 822.40			TL 50 mm	822.60
for bladder syringe 150 ml (822.31 and 822.40)					
Spare cylinder 150 ml			150 ml		82295

SEALING CAPS

Figure		Capacity Ø mm	Color	Product no.
Sealing cap Small, Pack = 10 PCS 	Sealing cap without hole	-	Red-orange	89.20
	Sealing cap capacity < 2.4 mm	< 2.4	Black	89.00
	Sealing cap capacity 2.4–3.4 mm	2.4–3.4	Red	89.01
	Sealing cap capacity 3.4–5.1 mm	3.4–5.1	Blue	89.02
	Sealing cap capacity 5.1–6.0 mm	5.1–6.0	Gray	89.03
	Sealing cap capacity 6.0–7.0 mm	6.0–7.0	Brown	89.04
	Sealing cap capacity 6.0–7.0 mm	7.0–8.0	Yellow	89.05
	Sealing cap capacity 9.5–10.1 mm	9.5–10.1	Red	89.08
	Sealing cap capacity > 10.1 mm	> 10.1	Blue	89.09
	Sealing cap capacity 13.0–13.8 mm	13.0–13.8	Red	89.10
	Sealing cap capacity 4–6 mm	4.0–6.0	Red	89.141
	Sealing cap capacity 7.5–8.5 mm	7.5–8.5	Blue	89.161
	Sealing cap capacity 7.0 mm	7.0	Brown	89.171
Sealing cap with cross-shaped slot 	for trocar sleeve with threaded sheath, Pack = 10 PCS	-	Red-orange	89.90
RIWO rubber cap Pack = 10 PCS 	RIWO rubber cap without hole	-	Red-orange	88.00
	RIWO rubber cap capacity 0.5 mm	0.5	Red	88.005
	RIWO rubber cap capacity 0.8 mm	0.8	Red-orange	88.01
	RIWO rubber cap capacity 1.4 mm	1.4	Blue	88.02
	RIWO rubber cap capacity 2.4 mm	2.4	Black	88.03
	RIWO rubber cap capacity 4.0 mm	4.0	Green	88.04
	Rubber cap for hysteroscope Extended, Pack = 1 PC	-	Red-orange	18.01



LUER-LOCK PARTS / STOPCOCKS AND IRRIGATION ADAPTERS / SEALING VALVE / ADAPTER/LASER ADJUSTMENT UNIT

		Hole		Product no.
	Tube with LUER-LOCK connector	Ø 3 mm	Male	886.00
	Tube with LUER-LOCK connector Ø 4 mm Length 29.5 mm	Ø 4 mm	Male	886.01
	Tube with LUER-LOCK connector Ø 3 mm Length 28 mm	Ø 3 mm	Female	891.00
	Tube with LUER-LOCK connector, 891.011	Ø 4 mm	Female	15023.041
	Stopcock LUER-LOCK connection Ø 3 mm	Ø 3 mm	Male	884.00
	Stopcock LUER-LOCK connection Ø 4 mm	Ø 4 mm	Male	884.01
	Two-way stopcock, maintenance-free with LUER-LOCK connection	Ø 3 mm	Male	88350
	Two-way stopcock, maintenance-free with LUER-LOCK connection	Ø 4 mm	Female	88351
	Adapter with 2 Luer connections, male, quick-release mechanism, TL 36 mm			7305.781
	Adapter with 2 irrigation valves and 1 instrument port, quick-release mechanism			7305.782
	Also: Luer sealing cap			15023205
	Universal sealing valve 1–6 Fr for inserting auxiliary instruments of 1–6 Fr			4712348
	Adapter for machine leakage tests			163.905
	Laser adjustment unit bndl			15369108
	Also: clamping element, orange (20 pcs)			15394144

RIGID FORCEPS AND SCISSORS

SMALL MODULAR SYSTEM **HySafe**

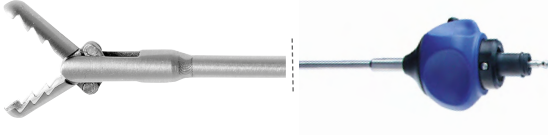
RECOMMENDED FOR CYSTOSCOPY



Grasping forceps jaw insert with sheath				Handle with overload protection	Complete instrument
					<ul style="list-style-type: none"> • Jaw section • Handle
	Product no.	Fr	WL	8083.001	Product no.
Grasping forceps bndl Distal angled with pike-mouth jaws	8642.6508	5	340 mm	•	8642.6502
	8645.6508	7	325 mm	•	8645.6502
Grasping forceps bndl - Spoon	8642.6008	5	340 mm	•	8642.6002
	8645.6008	7	340 mm	•	8645.6002
Biopsy forceps bndl	8642.6318	5	340 mm	•	8642.6312
Scissors bndl	8642.6818	5	340 mm	•	8642.6812
Hook scissors bndl Through-cutting	8992.6408	7	310 mm	•	8992.6402

IX23 || Subject to modifications. Please note that some products may not be available in all countries. Please always take note of the information that is provided with the product. For more detailed information, please consult with your contact partner or directly with Richard Wolf GmbH.

RIGID FORCEPS AND SCISSORS

SMALL MODULAR SYSTEM **HySafe**

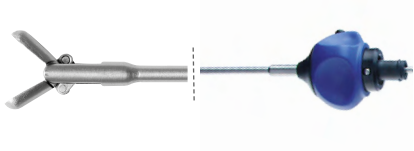







RECOMMENDED FOR URETERORENOSCOPY

Grasping forceps jaw insert with sheath				Handle with overload protection	Complete instrument
					<ul style="list-style-type: none"> Jaw section Handle
	Product no.	Fr	WL	8083.001	Product no.
Biopsy forceps bndl	8952.6008	5	550 mm	•	8952.6002
Grasping forceps bndl with mouse tooth	8952.6118	4	550 mm	•	8952.6112
	8959.6218	5	425 mm	•	8959.6212
	8952.6218	5	550 mm	•	8952.6212
Grasping forceps bndl	8959.6808	5	425 mm	•	8959.6802
	8954.6808	5	550 mm	•	8954.6802
Grasping forceps bndl with pike-mouth jaws, short	8952.6508	5	550 mm	•	8952.6502

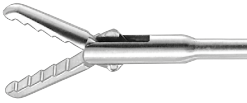
RIGID FORCEPS AND SCISSORS

SMALL MODULAR SYSTEM **HySafe**

RECOMMENDED FOR NEPHROSCOPY

Grasping forceps jaw insert with sheath				Handle with overload protection	Complete instrument • Jaw section • Handle
					
	Product no.	Fr	WL	8083.001	Product no.
Grasping forceps bndl Pike-mouth jaws 	8962.6008	10.5 Fr	350 mm	•	8962.6002
	8962.6048	12 Fr	355 mm	•	8962.6042
Grasping forceps bndl Distal angled Pike-mouth jaws 	8962.6028	9 Fr	355 mm	•	8962.6022
Grasping forceps bndl Pike-mouth jaws 	8962.6108	10.5 Fr	350 mm	•	8962.6102
Grasping forceps bndl Peanut shape, fine toothing 	8962.6078	12 Fr	340 mm	•	8962.6072
Grasping forceps bndl Mouse tooth 	8962.6058	12 Fr	340 mm	•	8962.6052
Grasping forceps bndl Pike-mouth jaws 	8962.6808	6 Fr	425 mm	•	8968.6802







IX23 || Subject to modifications. Please note that some products may not be available in all countries. Please always take note of the information that is provided with the product. For more detailed information, please consult with your contact partner or directly with Richard Wolf GmbH.

RIGID FORCEPS AND SCISSORS RECOMMENDED FOR NEPHROSCOPY

		Area of application	Fr	WL	Product no.
 Fine toothings	Rigid grasping forceps 5 Fr WL 340 mm	Surgical urethro-cystoscopy for infants	5	340 mm	8626.65
 Serrated	Biopsy forceps WL 270 mm	Intrarenal stone surgery	8	270 mm	8280.22
	Biopsy forceps WL 270 mm	Intrarenal stone surgery	6	270 mm	8280.23
	Scissors WL 230 mm	Intrarenal stone surgery	8	230 mm	8283.21

FLEXIBLE FORCEPS AND SCISSORS

RECOMMENDED FOR CYSTOSCOPY

		Fr	WL	TL	Product no.
	Flex. grasping forceps 3 Fr WL 230 mm	3	230 mm	380 mm	828.03
	Flex. grasping forceps 5 Fr WL 315 mm	5	315 mm	465 mm	828.05
	Flex. grasping forceps 7 Fr WL 365 mm	7	365 mm	515 mm	828.07
	Flex. grasping forceps 10 Fr WL 325 mm	10	325 mm	475 mm	828.10
	Flex. grasping forceps 5 Fr WL 550 mm	5	550 mm	720 mm	828.051
	Flex. biopsy forceps 3 Fr WL 230 mm	3	230 mm	380 mm	829.03
	Flex. biopsy forceps 5 Fr WL 315 mm	5	315 mm	465 mm	829.05
	Flex. biopsy forceps 7 Fr WL 375 mm	7	375 mm	490 mm	829.07
	Flex. biopsy forceps 10 Fr WL 325 mm	10	325 mm	475 mm	829.10
	Flex. biopsy forceps 5 Fr WL 550 mm	5	550 mm	720 mm	829.051
	Flex. scissors 7 Fr WL 375 mm	7	375 mm	490 mm	830.07
 Mouse tooth	Flex. grasping forceps 5 Fr WL 550 mm	5	550 mm	680 mm	8735.685
	Flex. grasping forceps 6.6 Fr WL 550 mm	6.6	550 mm	690 mm	8736.685

FLEXIBLE FORCEPS AND SCISSORS

RECOMMENDED FOR URETERORENOSCOPY



		Fr	WL	TL	Product no.
	Flex. grasping forceps 3 Fr WL 530 mm	3	530 mm	665 mm	828.605
	Flex. grasping forceps 5 Fr WL 550 mm	5	550 mm	720 mm	828.051
 Fine toothing	Flex. grasping forceps 3 Fr WL 920 mm	3	920 mm	1,050 mm	828.651
	Flex. biopsy forceps 5 Fr WL 550 mm	5	550 mm	720 mm	829.051
	Flex. biopsy forceps 3 Fr WL 530 mm	3	530 mm	665 mm	829.603
	Flex. biopsy forceps Ø 3 Fr WL 920 mm	3	920 mm	1,055 mm	829.601
	Flex. biopsy forceps 4 Fr WL 600 mm	4	600 mm	730 mm	8734.606
 Pike-mouth jaws	Flex. grasping forceps 4 Fr WL 600 mm	4	600 mm	750 mm	8734.656
 Mouse tooth	Flex. grasping forceps 4 Fr WL 600 mm	4	600 mm	750 mm	8734.686
	Flex. grasping forceps 5 Fr WL 550 mm	5	550 mm	700 mm	8735.685
	Flex. grasping forceps 3.5 Fr WL 550 mm, Fine toothing	3.5	550 mm	700 mm	8953.60

FLEXIBLE FORCEPS AND SCISSORS

RECOMMENDED FOR NEPHROSCOPY

		Fr	WL	TL	Product no.
	Flex. grasping forceps 3 Fr WL 530 mm	3	530 mm	665 mm	828.605
	Flex. grasping forceps 5 Fr WL 550 mm	5	550 mm	720 mm	828.051
	Flex. biopsy forceps 5 Fr WL 550 mm	5	550 mm	720 mm	829.051
 Mouse tooth	Flex. grasping forceps 5 Fr WL 550 mm	5	550 mm	680 mm	8735.685
	Flex. grasping forceps 6.6 Fr WL 550 mm	6.6	550 mm	690 mm	8736.685

ELECTRODES

		Area of applica- tion	Electrode shape	WL	Fr	Product no.
	Coag. electrode mono 5 Fr WL 600 mm	Ureterorenoscopy	Button	600 mm	5	8599.80
	Coag. electrode mono 4 Fr WL 400 mm	Cystoscopy	Button	400 mm	4	823.04
	Coag. electrode mono 5 Fr WL 400 mm				5	823.05
	Coag. electrode mono 6 Fr WL 400 mm				6	823.06
	Coag. electrode mono 10 Fr WL 400 mm				10	823.10
	Coag. electrode mono 3 Fr WL 580 mm	Ureterorenoscopy	Button	580 mm	3	823.031
	Hook electrode mono 2.4 Fr WL 600 mm	Ureterorenoscopy	Hook	600 mm	2.4	823.221

ELECTRODES

4.6

IX23 || Subject to modifications. Please note that some products may not be available in all countries. Please always take note of the information that is provided with the product. for more detailed information, please consult with your contact partner or directly with Richard Wolf GmbH.

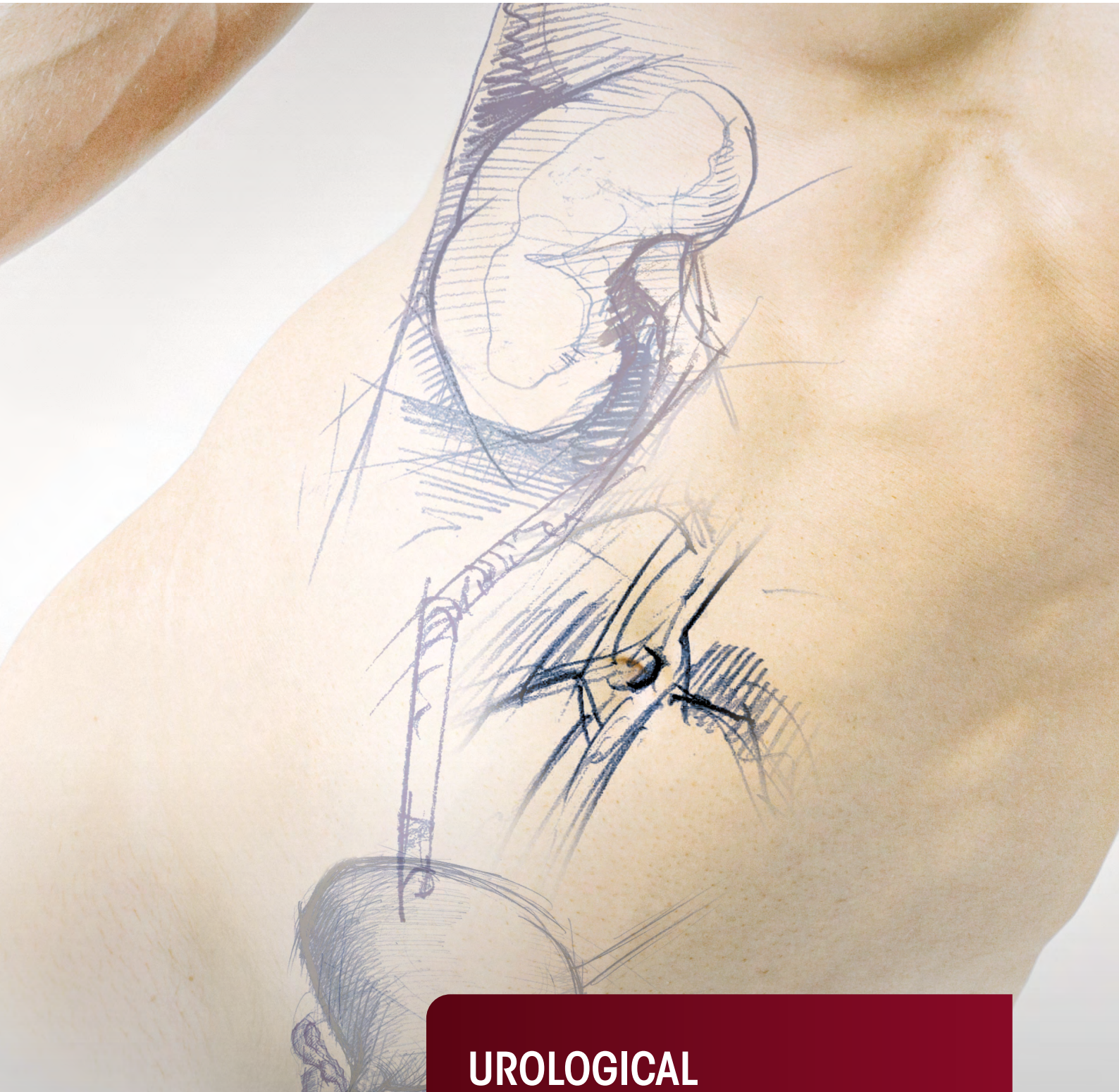

**UROLOGICAL
LAPAROSCOPY**

UROLOGICAL LAPAROSCOPY

1

BASIC SETS

2

TELESCOPES

3

TROCAR SLEEVES/DILATION/EXTRACTION/REDUCING SLEEVES

4

ERAGONMODULAR GRASPING FORCEPS/DISSECTORS/BIOPSY FORCEPS/SCISSORS

5

GRASPING FORCEPS

6

BIPOLAR FORCEPS AND SCISSORS

7

HF ELECTRODES (MONOPOLAR/BIPOLAR)

8

MULTIFUNCTIONAL SUCTION IRRIGATION SYSTEM

9

TISSUE RETRACTOR

10

CLIP APPLICATOR

11

NEEDLE HOLDER/KNOT PUSHER/FASCIA CLOSURE

12

CANNULAS/SURGICAL PROBES/MYOMA DRILLS

13

DEVICES/ACCESSORIES

14

CHOLEDOCHOSCOPY

15

TRAINING MODELS

BASIC SET

FOR ALL LAPAROSCOPIC PROCEDURES

Product	Product no.	Quantity	Catalog / Section
Insufflator 45 EVAC + HEAT bndl	22350312	1	Laparoscopy / 13
VERES cannula Ø 2.1 mm WL 120 mm	8302.12	1	Laparoscopy / 3
LAP suction irrigation pump bndl	22160011	1	Laparoscopy / 13
LED light source ENDOLIGHT LED 2.1 bndl	51630011	1	Imaging / Light sources
Fiber light cable		1	Imaging / Light cables
ENDOCAM Logic HD	5525	1	Imaging / ENDOCAM
Monitors		1	Imaging / Monitors
Device cart		1	Imaging / Device cart

BASIC SET

FOR LAPAROSCOPIC CHOLECYSTECTOMY

Product	Product no.	Quantity	Catalog / Section
Telescope 30° Ø 10 mm WL 307 mm	8934.432	1	Laparoscopy / 2
and/or			
Telescope 0° Ø 10 mm WL 307 mm	8934.431	1	Laparoscopy / 2
Fiber light cable bndl	806650231	1	Laparoscopy / 2
Trocar sleeve, slanted, capacity 5.5 mm WL 100 mm	8921.013	2-3	Laparoscopy / 3
and/or			
Trocar sleeve, straight, capacity 5.5 mm WL 102 mm	8919.351	2-3	Laparoscopy / 3
Trocar sleeve, slanted, capacity 10 mm WL 100 mm	8923.013	2	Laparoscopy / 3
Guide rod 5.5 mm TL 500 mm	8923.921	1	Laparoscopy / 3
Instrument sleeve 10 mm WL 170 mm	8385.50	1	Laparoscopy / 3
VERES cannula Ø 2.1 mm WL 120 mm	8302.12	1	Laparoscopy / 3
Multifunctional suction irrigation system			
Suction irrigation tube Ø 5 mm WL 310 mm	8383.911	1	Laparoscopy / 8
Suction irrigation handle	8385.901	1	Laparoscopy / 8
Sealing cap	8385.902	1	Laparoscopy / 8
ERAGONmodular			
Atraumatic grasping forceps Ø 5 mm bndl	83932925	1	Laparoscopy / 4
Atraumatic grasping forceps mono Ø 5 mm bndl	83931817	2	Laparoscopy / 4
Maryland dissector forceps mono Ø 5 mm bndl	83932817	1	Laparoscopy / 4
Metzenbaum scissors Ø 5 mm bndl	83930417	1	Laparoscopy / 4
Grasping forceps Ø 10 mm bndl	83952048	1	Laparoscopy / 4
Plate-shaped grasping forceps Ø 10 mm bndl	83952347	1	Laparoscopy / 4
Hook electrode mono Ø 5 mm WL 340 mm			
Clip applicator Ø 10 mm WL 340 mm	8389.911	1	Laparoscopy / 10
Ethicon® Ligaclips® (PACK= 108 PCS)	8389.915	1	Laparoscopy / 10
Needle forceps Ø 2.45 mm WL 160 mm	8756.201	1	Laparoscopy / 11
Sealing cone Ø 12-15 mm	8943.915	1	Laparoscopy / 11
Monopolar HF cable	8106	2	Laparoscopy / 13

BASIC SET

FOR LAPAROSCOPIC CHOLECYSTECTOMY

Product	Product no.	Quantity	Catalog / Section
Also on request:			
Telescope 30° Ø 5.3 mm WL 303 mm	8935442	1	Laparoscopy / 2
Trocar sleeve, slanted, capacity 5.5 mm WL 100 mm	8921.013	1	Laparoscopy / 3
Trocar tip sharp size 5.5 mm WL 169 mm	8921.113	1	Laparoscopy / 3
ERAGONmodular			
Atraumatic grasping forceps mono Ø 5 mm bndl	83931957	1	Laparoscopy / 4
Biopsy forceps mono Ø 5 mm bndl	83930937	1	Laparoscopy / 4
Dissector forceps Ø 10 mm bndl	83952268	1	Laparoscopy / 4
ERAGONbipolar			
Grasping forceps bipo Ø 5.5 mm bndl	839300312	1	Laparoscopy / 6

In addition to laparoscopic choledochus revision			
Grasping forceps Ø 5 mm WL 295 mm	8383311	1	Laparoscopy / 5

BASIC SET

FOR LAPAROSCOPIC APPENDECTOMY

Product	Product no.	Quantity	Catalog / Section
Telescope 30° Ø 10 mm WL 307 mm	8934.432	1	Laparoscopy / 2
and/or			
Telescope 0° Ø 10 mm WL 307 mm	8934.431	1	Laparoscopy / 2
Fiber light cable bndl	806650231	1	Laparoscopy / 2
Trocar sleeve, slanted, capacity 10 mm WL 100 mm	8923.013	2	Laparoscopy / 3
Trocar tip sharp size 10 mm	8923.113	2	Laparoscopy / 3
and/or			
Trocar sleeve, straight, capacity 5.5 mm WL 102 mm	8919.351	2-3	Laparoscopy / 3
Trocar tip sharp size 5.5 mm WL 144 mm	8919.3512	2-3	Laparoscopy / 3
Trocar sleeve, slanted, capacity 5.5 mm WL 100 mm	8921.013	2-3	Laparoscopy / 3
Trocar tip sharp size 5.5 mm WL 169 mm	8921.113	2-3	Laparoscopy / 3
Guide rod 5.5 mm TL 500 mm	8923.921	1	Laparoscopy / 3
Instrument sleeve 10 mm WL 170 mm	8385.50	1	Laparoscopy / 3
ERAGONmodular			
Grasping forceps mono Ø 5 mm bndl	83932877	1	Laparoscopy / 4
Atraumatic grasping forceps mono Ø 5 mm bndl	83931817	2	Laparoscopy / 4
Maryland dissector forceps mono Ø 5 mm bndl	83932817	1	Laparoscopy / 4
Metzenbaum scissors Ø 5 mm bndl	83930417	1	Laparoscopy / 4
Grasping and dissector forceps 5 mm	83932827	1	Laparoscopy / 4
ERAGONbipolar			
Grasping forceps bipo Ø 5.5 mm bndl	839300312	1	Laparoscopy / 6
Multifunctional suction irrigation system			
Suction irrigation tube Ø 5 mm WL 310 mm	83839.11	1	Laparoscopy / 8
Suction irrigation handle	8385.901	1	Laparoscopy / 8
Sealing cap	8385.902	1	Laparoscopy / 8
Surgical probe Ø 5 mm WL 328 mm			
Surgical probe Ø 5 mm WL 328 mm	8383.66	1	Laparoscopy / 12
VERES cannula Ø 2.1 mm WL 120 mm	8302.12	1	Laparoscopy / 3
Bipolar HF cable	8108	1	Laparoscopy / 13
Monopolar HF cable	8106	1	Laparoscopy / 13

BASIC SET

FOR LAPAROSCOPIC APPENDECTOMY

Product	Product no.	Quantity	Catalog / Section
Also on request:			
ERAGONmodular			
Dissector forceps mono Ø 5 mm bndl	83932897	1	Laparoscopy / 4
Grasping forceps mono Ø 5 mm bndl	83931837	2	Laparoscopy / 4
Biopsy forceps mono Ø 5 mm bndl	83930917	1	Laparoscopy / 4
Maryland dissector forceps Ø 10 mm bndl	83952257	1	Laparoscopy / 4
Clip applicator Ø 10 mm WL 340 mm	8389.911	1	Laparoscopy / 10
Ethicon® Ligaclips® (PACK= 108 PCS)	8389.915	1	Laparoscopy / 10
Introduction sleeve 10 mm WL 80 mm	8389.991	1	Laparoscopy / 10
Needle holder Ø 5 mm bndl	8393.502	1	Laparoscopy / 11

BASIC SET LEVD

LAPAROSCOPIC SINGLE-CHANNEL VARICOCELE DISSECTION

Product	Product no.	Quantity	Catalog / Section
OR endoscope bndl	8920.4011	1	Laparoscopy / 2
Perforated basket for telescope	38008		Laparoscopy / 2
Fiber light cable bndl	806625231	1	Laparoscopy / 2
Trocar sleeve, straight, capacity 5.5 mm WL 102 mm	8919.353	1	Laparoscopy / 3
Optional:			
Trocar tip blunt size 5.5 mm WL 144 mm	8919.3511	1	Laparoscopy / 3
Trocar tip sharp size 5.5 mm WL 144 mm	8919.3512	1	Laparoscopy / 3
Trocar tip triangular size 5.5 mm WL 144 mm	8919.3513	1	Laparoscopy / 3
ERAGONmodular mini			
Universal grasping forceps Ø 3.5 mm bndl	83912097	1	Laparoscopy / 4
Atraumatic grasping forceps Ø 3.5 mm bndl	83912087	1	Laparoscopy / 4
Babcock forceps Ø 3.5 mm bndl	83912107	1	Laparoscopy / 4
Dissector forceps mono Ø 3.5 mm bndl	83912077	1	Laparoscopy / 4
Hook scissors mono Ø 3.5 mm bndl	83912277	1	Laparoscopy / 4
Metzenbaum scissors mono Ø 3.5 mm bndl	83912247	1	Laparoscopy / 4
Connection cable			
Bipolar HF cable	8108	1	Laparoscopy / 13
Monopolar HF cable	8106	1	Laparoscopy / 13

BASIC SET

MINI E-MILOS

Product	Product no.	Quantity	Catalog / Section
Telescope 30° Ø 10 mm WL 307 mm	8934.432	1	Laparoscopy / 2
Light tube for MILOS method Ø 10 mm	893420	1	Laparoscopy / 2
Trocar sleeve, straight, capacity 3.5 mm WL 100 mm	8903.014	2	Laparoscopy / 3
Trocar tip blunt size 3.5 mm WL 169 mm	8903.103	2	Laparoscopy / 3
ERAGONmodular mini			
Handle, pistol-shaped, mono	83930073	4	Laparoscopy / 4
Sheath tube insulated Ø 3.5 mm SL 330 mm	8391933	4	Laparoscopy / 4
Dissector forceps insert Ø 3.5 mm	8391222	1	Laparoscopy / 4
Metzenbaum scissors insert Ø 3.5 mm	8391215	1	Laparoscopy / 4
Grasping forceps insert Ø 3.5 mm	8391208	2	Laparoscopy / 4
Electrode			
Hook electrode mono Ø 3.5 mm WL 310 mm	8379.452	1	Laparoscopy / 7
ERAGONstitch			
Needle holder insert Ø 3.5 mm	8391506	1	Laparoscopy / 11
Sheath tube Ø 3.5 mm SL 330 mm	8391533	1	Laparoscopy / 11
Needle holder handle, axial	8393943	1	Laparoscopy / 11

BASIC SET

E-MILOS

Product	Product no.	Quantity	Catalog / Section
Telescope 30° Ø 10 mm WL 307 mm	8934.432	1	Laparoscopy / 2
Light tube for MILOS method Ø 10 mm	893420	1	Laparoscopy / 2
Trocar sleeve, straight, capacity 5.5 mm WL 100 mm	8921.014	2	Laparoscopy / 3
Trocar tip blunt size 5.5 mm WL 169 mm	8921.103	2	Laparoscopy / 3
ERAGONmodular			
Handle, pistol-shaped, mono	83930073	4	Laparoscopy / 4
Sheath tube insulated Ø 5 mm SL 330 mm	8391933	4	Laparoscopy / 4
Dissector forceps insert Ø 5 mm	8393240	1	Laparoscopy / 4
Metzenbaum scissors insert Ø 5 mm	8393.041	1	Laparoscopy / 4
Grasping forceps insert Ø 5 mm	8393.181	2	Laparoscopy / 4
Electrode			
Hook electrode mono Ø 5 mm WL 340 mm	8383.423	1	Laparoscopy / 7
ERAGONstitch			
Needle holder insert Ø 5 mm	8393508	1	Laparoscopy / 11
Sheath tube Ø 5 mm SL 330 mm	8393533	1	Laparoscopy / 11
Needle holder handle, axial	8393943	1	Laparoscopy / 11

BASIC SET

LAPAROSCOPIC BARIATRIC SURGERY

Product	Product no.	Quantity	Catalog / Section
Telescope 0° Ø 10 mm WL 305 mm	8934461	1	Laparoscopy / 2
Telescope 30° Ø 10 mm WL 305 mm	8934462	1	Laparoscopy / 2
Fiber light cable bndl	806550231	1	Laparoscopy / 2
Trocar sleeve, straight, capacity 5.5 mm WL 150 mm	8921.016	3	Laparoscopy / 3
Trocar sleeve, straight, capacity 10 mm WL 150 mm	8923.016	1	Laparoscopy / 3
Trocar sleeve, straight, capacity 12.5 mm WL 150 mm	8924.016	1	Laparoscopy / 3
Optional:			
Trocar tip sharp size 5.5 mm	8921.115	3	Laparoscopy / 3
Trocar tip sharp size 10 mm	8923.115	1	Laparoscopy / 3
Trocar tip sharp size 12.7 mm	8924.115	1	Laparoscopy / 3
Reducing adapter	8923.802	1	Laparoscopy / 3
Multifunctional suction irrigation system			
Suction irrigation tube Ø 5 mm WL 450 mm	8384.911	1	Laparoscopy / 8
Suction irrigation handle	8385.901	1	Laparoscopy / 8
Sealing cap	8385.902	1	Laparoscopy / 8
Suction irrigation tube set with piercing spike L 3 m	4170.956	1	Laparoscopy / 8
ERAGONmodular			
Atraumatic grasping forceps mono Ø 5 mm bndl	83941817	1	Laparoscopy / 4
Dissector forceps mono Ø 5 mm bndl	83942407	1	Laparoscopy / 4
Metzenbaum scissors mono Ø 5 mm bndl	83940417	1	Laparoscopy / 4
Atraumatic Grasping forceps Ø 5 mm bndl	83942297	1	Laparoscopy / 4
Biopsy forceps mono Ø 5 mm bndl	83940917	1	Laparoscopy / 4
Atraumatic Grasping forceps Ø 5 mm bndl	83942507	1	Laparoscopy / 4
Stapler head grasping forceps Ø 10 mm bndl	83976558	1	Laparoscopy / 4
Plate-shaped grasping forceps Ø 10 mm bndl	83962347	1	Laparoscopy / 4
Babcock forceps Ø 10 mm bndl	83961877	1	Laparoscopy / 4
ERAGONbipolar			
Maryland dissector bipo Ø 5.5 mm bndl	839400322	1	Laparoscopy / 6
Metzenbaum scissors bipo Ø 5.5 mm bndl	839400412	1	Laparoscopy / 6
Electrode			
Hook electrode mono Ø 5 mm WL 420 mm	8384.423	1	Laparoscopy / 7

BASIC SET

LAPAROSCOPIC BARIATRIC SURGERY

Product	Product no.	Quantity	Catalog / Section
Clip applicator Ø 10 mm WL 340 mm	8389.911	1	Laparoscopy / 10
Ethicon® Ligaclips® (PACK= 108 PCS)	8389.915	1	Laparoscopy / 10
Needle holder Ø 5 mm bndl with carbide insert	8394.502	1	Laparoscopy / 11
Needle holder Ø 5 mm bndl curved to the right with carbide insert	8394.511	1	Laparoscopy / 11
Needle forceps Ø 2.45 mm WL 160 mm	8756.201	1	Laparoscopy / 11
Sealing cone Ø 12–15 mm	8943.915	1	Laparoscopy / 11
Sealing cone Ø 10–12 mm	8934.915	1	Laparoscopy / 11
VERES cannula Ø 2.1 mm WL 120 mm	8302.12	1	Laparoscopy / 3
Handle, axial, mono	83930084	1	Laparoscopy / 4
Rotatable knob	8988	1	Laparoscopy / 4
Connection cable			
Mono HF connection cable L 3 m	8106.033	1	Laparoscopy / 13
Bipo HF connection cable L 3 m	8108.132	1	Laparoscopy / 13

MINI FIBER TELESCOPES 2.0 MM

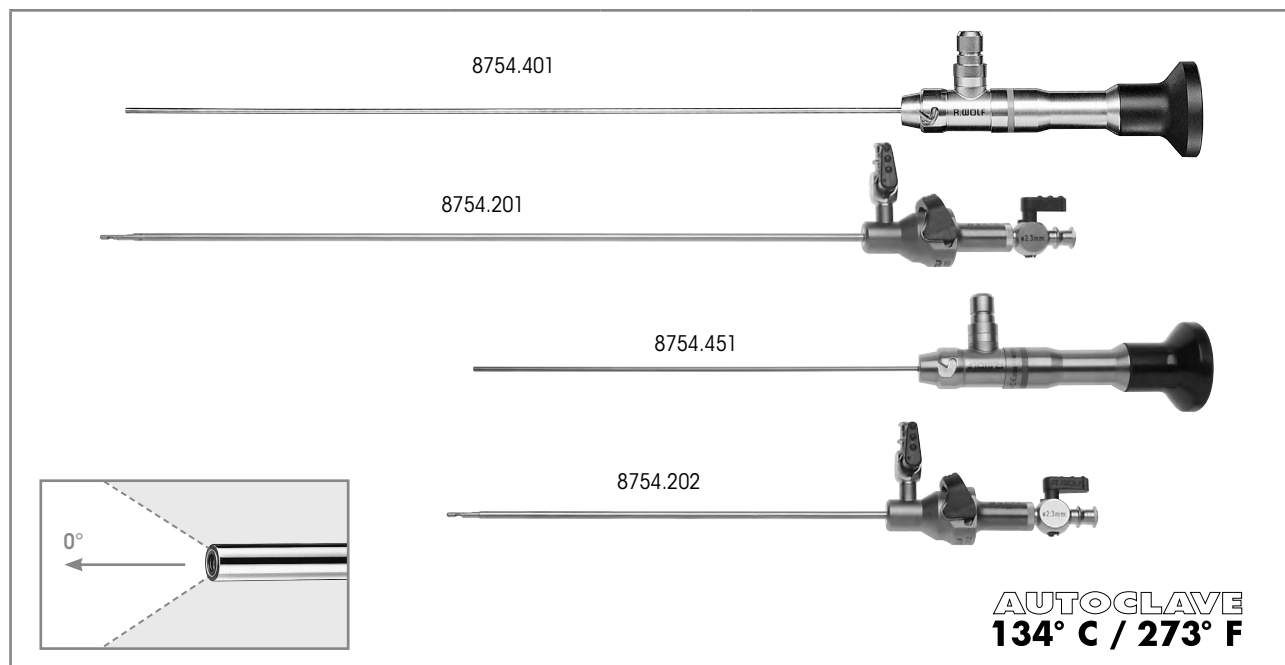

Long version	Direction of view	WL	TL	Ø	Product no.
Telescope 0° Ø 2 mm NL 268 mm	0°	268 mm	365 mm	2.0 mm	8754.401
for this:					
VERES cannula Ø 2.3 mm WL 250 mm consisting of: 1x VERES cannula Ø 2.3 mm WL 274 mm (8754.211) 1x outer sheath Ø 2.8 mm, WL 250 mm (8754.221)		250 mm		2.3 mm	8754.201
Short version	Direction of view	WL	TL	Ø	Product no.
Telescope 0° Ø 2 mm NL 158 mm	0°	158 mm	255 mm	2.0 mm	8754.451
for this:					
VERES cannula Ø 2.3 mm WL 170 mm consisting of: 1x VERES cannula Ø 2.3 mm WL 164 mm (8754.212) 1x outer sheath Ø 2.8 mm WL 141 mm (8754.222)		170 mm		2.3 mm	8754.202
Recommended accessories					Product no.
Perforated basket for standard telescope 1 (for telescope 8754.451)		(W x H x D) 297 x 54 x 59 mm			38015
Perforated basket for standard telescope 2 (for telescope 8754.401)		(W x H x D) 481 x 54 x 59 mm			38016
Fiber light cable bndl consisting of: Fiber light cable (80662523), projector-side adapter (8095.07), and endoscope-side adapter (809509)		Ø 2.5 mm, 2.3 m long			806625231

V124 || Subject to modifications. Please note that some products may not be available in all countries. Please always take note of the information that is provided with the product. For more detailed information, please consult with your contact partner or directly with Richard Wolf GmbH.

LAPAROSCOPES 3.5 MM

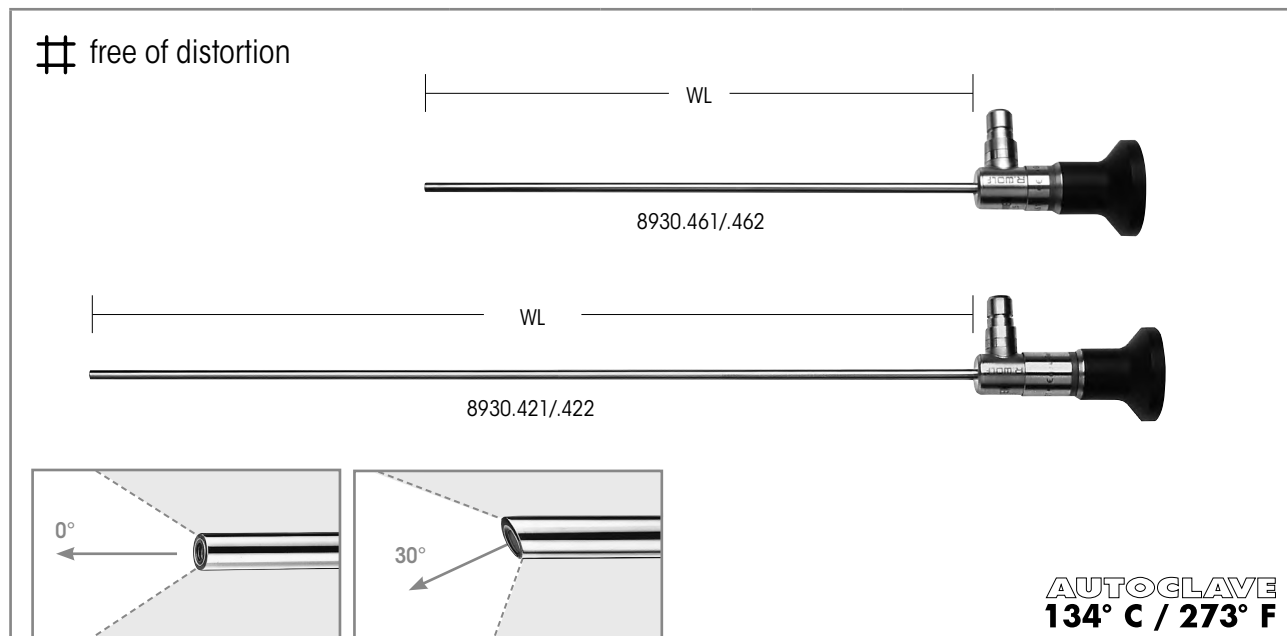

	Direction of view	WL	TL	Ø	Product no.
PANOVIEW PLUS Telescope 0° 3.5 mm WL 180 mm	0°	180 mm	232 mm	3.5 mm	8930.461
PANOVIEW PLUS Telescope 30° 3.5 mm WL 180 mm	30°		233 mm		8930.462
PANOVIEW PLUS Telescope 0° Ø 3.5 mm WL 300 mm	0°	300 mm	361 mm		8930.421
PANOVIEW PLUS Telescope 30° 3.5 mm WL 300 mm	30°		362 mm		8930.422

Recommended accessories		Product no.
Perforated basket for standard telescope 1 (for telescope 8930.461/.462)	(W x H x D) 297 x 54 x 59 mm	38015
Perforated basket for standard telescope 2 (for telescope 8930.421/.422)	(W x H x D) 481 x 54 x 59 mm	38016
Fiber light cable bndl consisting of: Fiber light cable (80662523), projector-side adapter (8095.07), and endoscope-side adapter (809509)	Ø 2.5 mm, 2.3 m long	806625231

V124 | Subject to modifications. Please note that some products may not be available in all countries. Please always take note of the information that is provided with the product. For more detailed information, please consult with your contact partner or directly with Richard Wolf GmbH.

LAPAROSCOPES 5.3 MM

free of distortion

full screen

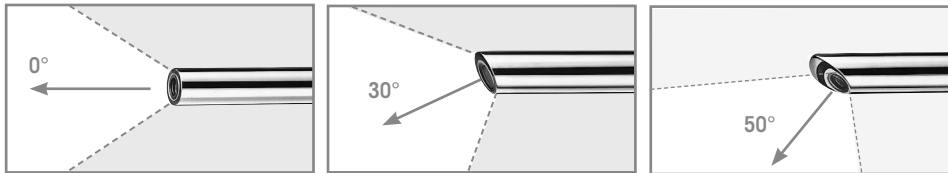
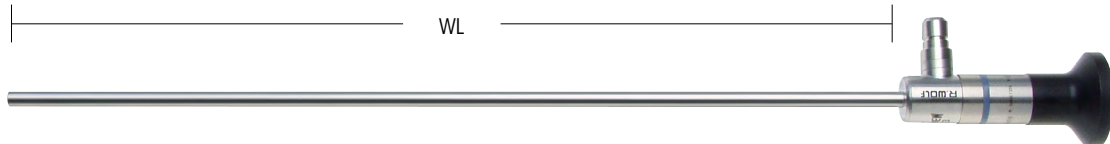

AUTOCLAVE
134° C / 273° F

	Direction of view	WL	TL	Ø	Product no.
PANOVIEW Telescope 0° Ø 5.3 mm WL 303 mm	0°	303 mm	372 mm	5.3 mm	8935.441
PANOVIEW Telescope 30° Ø 5.3 mm WL 303 mm	30°		373 mm		8935.442
PANOVIEW Telescope 50° Ø 5.3 mm WL 309 mm	50°	309 mm	377 mm		8935.443

Recommended accessories		Product no.
Perforated basket for standard telescope 2	(W x H x D) 481 x 54 x 59 mm	38016
Fiber light cable bndl consisting of: Fiber light cable (80662523), projector-side adapter (8095.07), and endoscope-side adapter (809509)	Ø 2.5 mm, 2.3 m long	806625231

V124 || Subject to modifications. Please note that some products may not be available in all countries. Please always take note of the information that is provided with the product. For more detailed information, please consult with your contact partner or directly with Richard Wolf GmbH.

MINI OR LAPAROSCOPE
5.5 MM WITH 3.5 MM WORKING CHANNEL

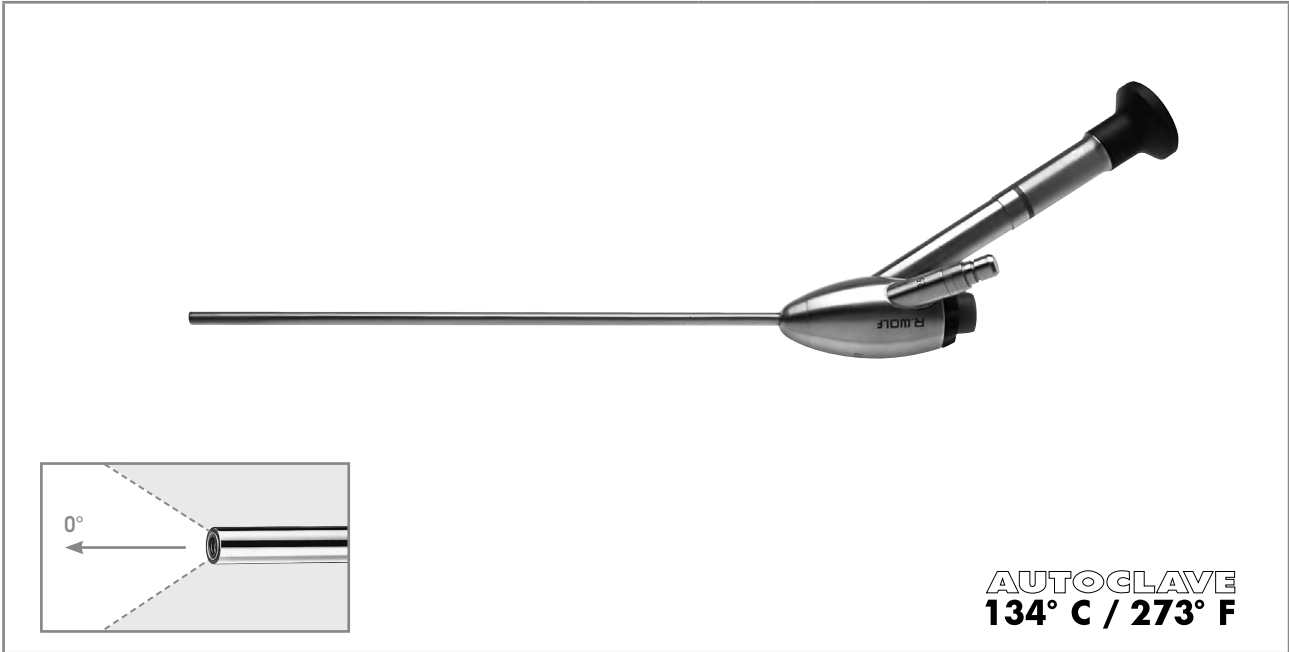

	Direction of view	SL	TL	Ø	Working channel Ø	Product no.
OR endoscope bndl consisting of: OR endoscope 0° Ø 5.5 mm SL 215 mm (8920.401) Autom. sealing element ID 5.7 mm (8920.311) Sealing cap, red-orange (15176.020) Sealing membrane Ø 17 mm (PACK= 10 PCS) (89.103)	0°	215 mm	370 mm	5.5 mm	3.5 mm	8920.4011

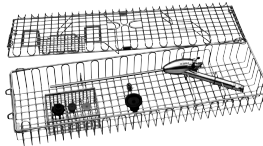
Recommended accessories		Product no.
Trocar sleeve, straight, capacity 5.5 mm WL 62 mm		8919.333
Trocar sleeve, straight, capacity 5.5 mm WL 102 mm		8919.353
Perforated basket for telescope Dimensions (W x L x H): 132 x 467 x 75 mm		38008
Fiber light cable bndl consisting of: Fiber light cable (80663523), projector-side adapter (8095.07), and endoscope-side adapter (809509)	Ø 3.5 mm, 2.3 m long	806635231

V124 || Subject to modifications. Please note that some products may not be available in all countries. Please always take note of the information that is provided with the product. For more detailed information, please consult with your contact partner or directly with Richard Wolf GmbH.

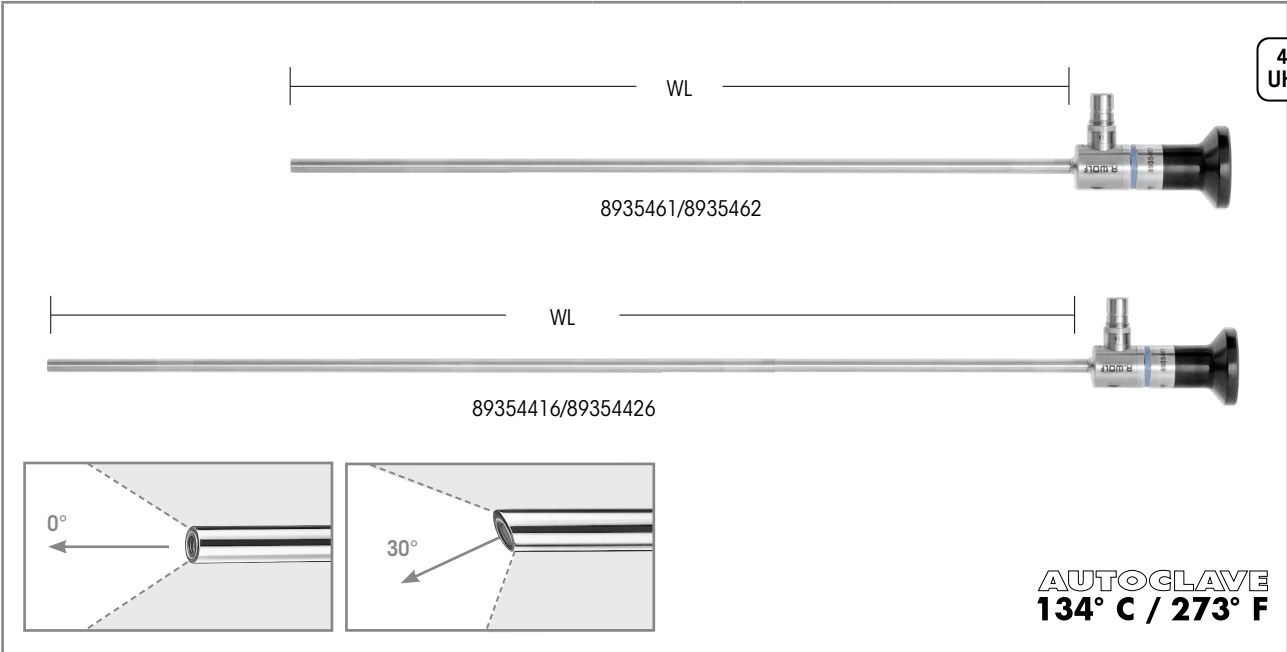

	Direction of view	WL	Ø	Product no.
PANOVIEW ULTRA Telescope Ø 5.5 mm WL 300 mm	0°	300 mm	5.5 mm	8935461
PANOVIEW ULTRA Telescope Ø 5.5 mm WL 300 mm	30°			8935462
PANOVIEW ULTRA Telescope Ø 5.5 mm WL 430 mm	0°	430 mm		89354416
PANOVIEW ULTRA Telescope Ø 5.5 mm WL 430 mm	30°			89354426

Recommended accessories		Product no.
Perforated basket for standard telescope 2 (for telescope 8935416/8935426)	(W x H x D) 481 x 54 x 59 mm	38016
Perforated basket for standard telescope 3 (for telescope 89354416/89354426)	(W x H x D) 619 x 54 x 59 mm	38017
Fiber light cable bndl consisting of: Fiber light cable (80663523), projector-side adapter (8095.07), and endoscope-side adapter (809509)	Ø 3.5 mm, 2.3 m long	806635231

V124 || Subject to modifications. Please note that some products may not be available in all countries. Please always take note of the information that is provided with the product. For more detailed information, please consult with your contact partner or directly with Richard Wolf GmbH.

LAPAROSCOPES 10 MM

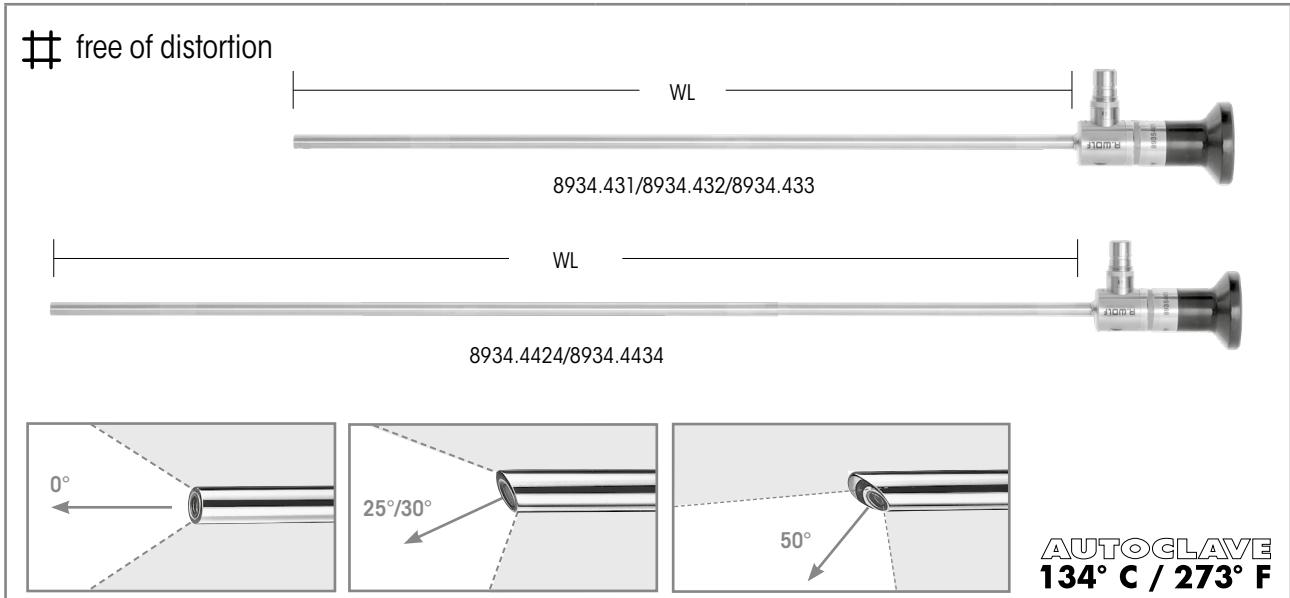

	Direction of view	WL	TL	Ø	Product no.
PANOVIEW Telescope 0° Ø 10 mm WL 307 mm	0°	307 mm	375 mm	10 mm	8934.431
PANOVIEW Telescope 30° Ø 10 mm WL 307 mm	30°	307 mm	375 mm		8934.432
PANOVIEW Telescope 50° Ø 10 mm WL 310 mm	50°	310 mm	378 mm		8934.433
PANOVIEW PLUS Telescope 25° Ø 10 mm WL 438 mm	25°	438 mm	507 mm		8934.4424
PANOVIEW PLUS Telescope 50° Ø 10 mm WL 447 mm	50°	447 mm	516 mm		8934.4434

Recommended accessories		Product no.
Perforated basket for standard telescope 2 (for telescope 8934.431/.432/.433)	(W x H x D) 481 x 54 x 59 mm	38016
Perforated basket for standard telescope 3 (for telescope 8934.4424/.4434)	(W x H x D) 619 x 54 x 59 mm	38017
Fiber lightcable bndl consisting of: Fiber light cable Ø 5 mm TL 2.3 m (80665023), projector-side adapter (8095.07), and endoscope-side adapter (809509)	Ø 5.0 mm, 2.3 m long	806650231
Fusion Fiber light cable bndl consisting of: Fiber light cable Ø 5 mm TL 2.3 m (80655023), projector-side adapter (8095.07), and endoscope-side adapter (809509)	Ø 5.0 mm, 2.3 m long	806550231

V124 | Subject to modifications. Please note that some products may not be available in all countries. Please always take note of the information that is provided with the product. For more detailed information, please consult with your contact partner or directly with Richard Wolf GmbH.

3D ENDOSCOPE 10 MM

V124 || Subject to modifications. Please note that some products may not be available in all countries. Please always take note of the information that is provided with the product. For more detailed information, please consult with your contact partner or directly with Richard Wolf GmbH.

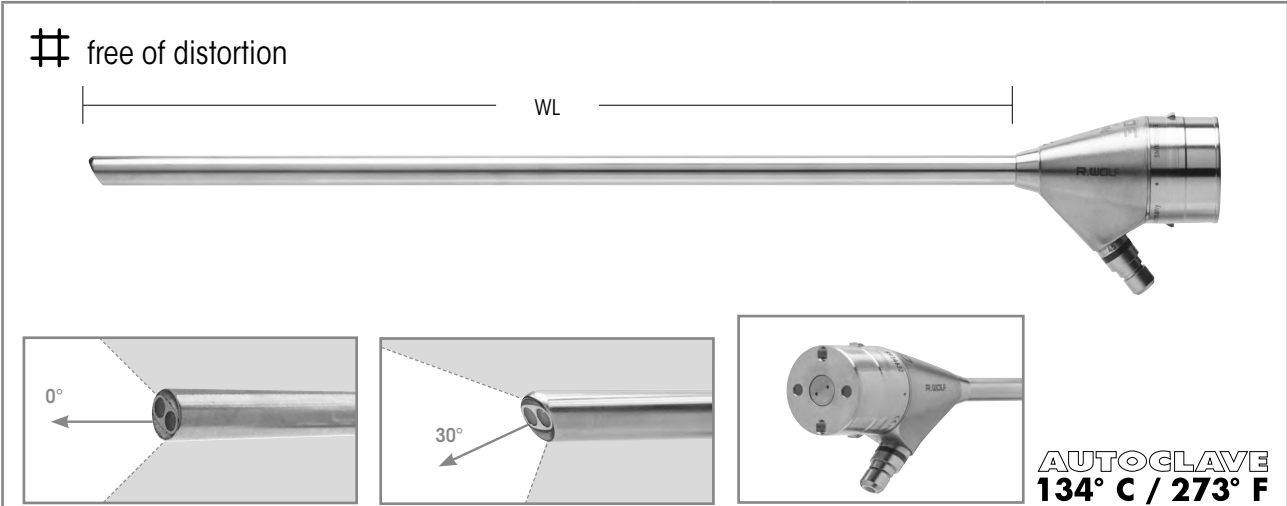

	Direction of view	WL	TL	Ø	Product no.
3D endoscope 0° Ø 10 mm WL 300 mm	0°	300 mm	366 mm	10 mm	8934631
3D endoscope 0° Ø 10 mm WL 435 mm		435 mm	500 mm		89344631
3D endoscope 30° Ø 10 mm WL 301 mm	30°	301 mm	366 mm		8934632
3D endoscope 30° Ø 10 mm WL 435 mm		435 mm	501 mm		89344632

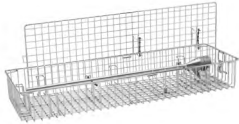
Recommended accessories		Product no.
Perforated basket for 3D telescope 	(W x H x D): 583 x 200 x 80 mm	38014
Fusion Fiber light cable bndl consisting of: Fiber light cable Ø 5 mm TL 2.3 m (80655023), projector-side, adapter (8095.07), and endoscope-side adapter (809509)	Ø 5.0 mm, 2.3 m long	806550231

SURGICAL LAPAROSCOPE 10 MM

FOR ONE HOLE APPENDECTOMY

TELESCOPES

2

free of distortion

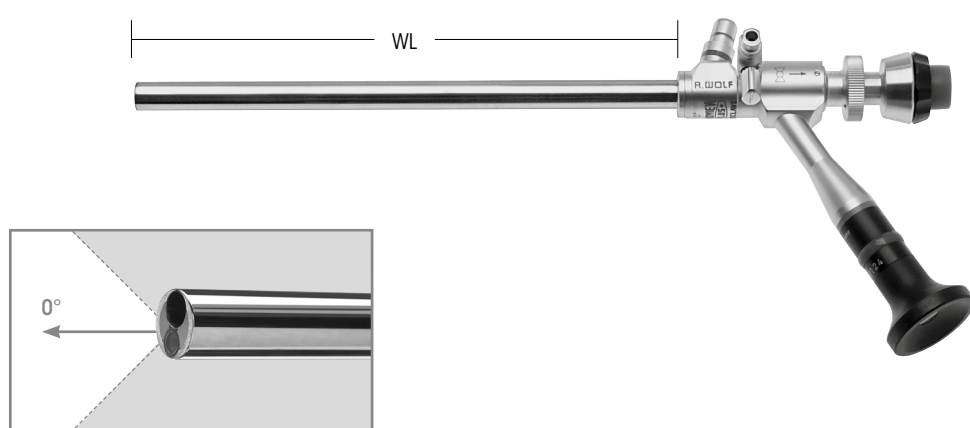

AUTOCLAVE
134° C / 273° F

	Direction of view	WL	TL	Ø	Working channel Ø	Product no.
PANOVIEW PLUS OR endoscope 0° Ø 10 mm WL 188 mm with lateral eyepiece	0°	188 mm	285 mm	10 mm	5.1 mm	8915.501

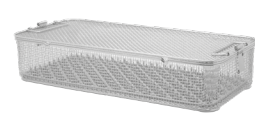
Recommended accessories		Product no.
Universal perforated basket 4 (W x H x D): 538 x 117 x 250 mm		33004
for this: Instrument mat for perforated basket		33001
Fiber light cable bndl consisting of: Fiber light cable Ø 5 mm TL 2.3 m (80655023), projector-side adapter (8095.07), and endoscope-side adapter (809509)	Ø 5.0 mm, 2.3 m long	806650231
Fusion Fiber light cable bndl consisting of: Fiber light cable Ø 5 mm TL 2.3 m (80655023), projector-side adapter (8095.07), and endoscope-side adapter (809509)	Ø 5.0 mm, 2.3 m long	806550231

V124 | Subject to modifications. Please note that some products may not be available in all countries. Please always take note of the information that is provided with the product. For more detailed information, please consult with your contact partner or directly with Richard Wolf GmbH.



AUTOCLAVE
134° C / 273° F



	Direction of view	WL	TL	Ø	Product no.
PANOVIEW ULTRA Telescope 0° Ø 10 mm WL 305 mm	0°	305 mm	375 mm	10 mm	8934461
PANOVIEW ULTRA Telescope 30° Ø 10 mm WL 305 mm	30°				8934462
PANOVIEW ULTRA Telescope 50° Ø 10 mm WL 305 mm	50°				8934463

4K UHD
ICG NIR

Note: Compatible with System green (see Imaging Catalog) (ICG/NIR-capable) and its recommended Fusion fiber light cable

Recommended accessories		Product no.
Perforated basket for standard telescope 2	(W x H x D) 481 x 54 x 59 mm	38016
Fiber lightcable bndl consisting of: Fiber light cable Ø 5 mm TL 2.3 m (80665023), projector-side adapter (8095.07), and endoscope-side adapter (809509)	Ø 5.0 mm, 2.3 m long	806650231
Fusion fiber lightcable bndl consisting of: Fiber light cable Ø 5 mm TL 2.3 m (80655023), projector-side adapter (8095.07), and endoscope-side adapter (809509)	Ø 5.0 mm, 2.3 m long	806550231

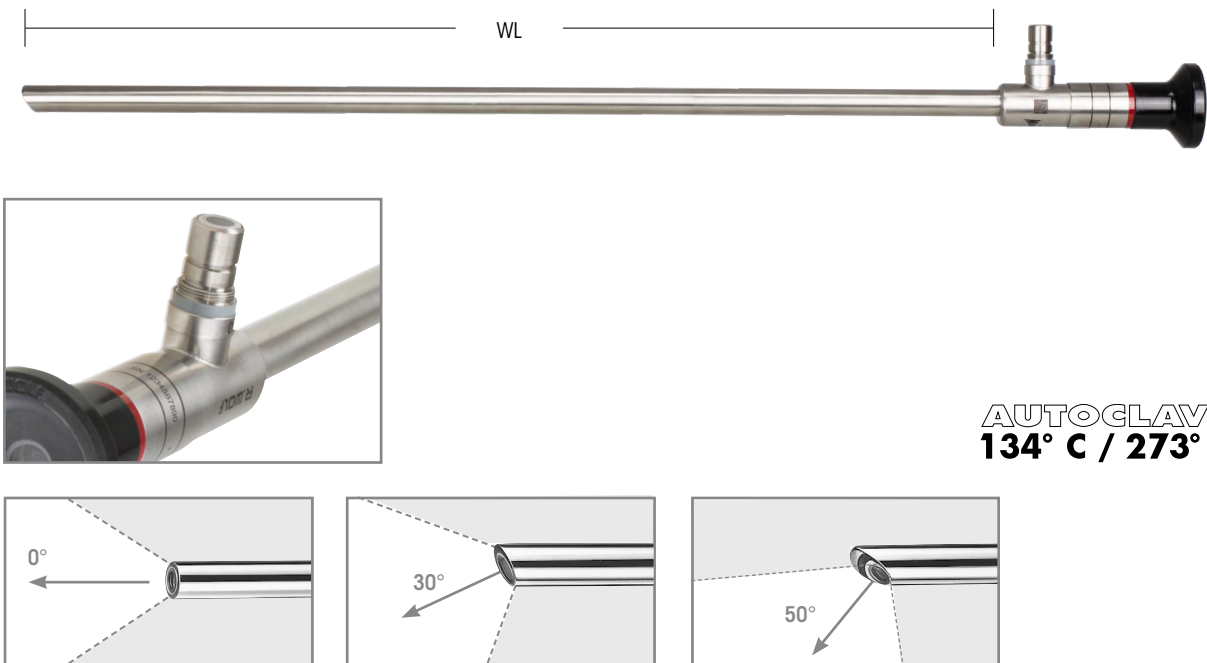

4K UHD
ICG NIR

AUTOCLAVE
134° C / 273° F

	Direction of view	WL	TL	Ø	Product no.
PANOVIEW ULTRA Telescope 0° Ø 10 mm WL 440 mm	0°	440 mm	510 mm	10 mm	89344416
PANOVIEW ULTRA Telescope 30° Ø 10 mm WL 440 mm	30°				89344426
PANOVIEW ULTRA Telescope 50° Ø 10 mm WL 440 mm	50°				89344436

Note: Compatible with System green (see Imaging Catalog) (ICG/NIR-capable) and its recommended Fusion fiber light cable

Recommended accessories		Product no.
Perforated basket for standard telescope 3	(W x H x D) 619 x 54 x 59 mm	38017
Fiber lightcable bndl consisting of: Fiber light cable Ø 5 mm TL 2.3 m (80665023), projector-side adapter (8095.07), and endoscope-side adapter (809509)	Ø 5.0 mm, 2.3 m long	806650231
Fusion Fiber light cable bndl consisting of: Fiber light cable Ø 5 mm TL 2.3 m (80655023), projector-side adapter (8095.07), and endoscope-side adapter (809509)	Ø 5.0 mm, 2.3 m long	806550231

V124 | Subject to modifications. Please note that some products may not be available in all countries. Please always take note of the information that is provided with the product. For more detailed information, please consult with your contact partner or directly with Richard Wolf GmbH.

**LIGHT TUBE FOR MILOS METHOD
(MINI LESS OPEN SUBLAY METHOD)**



**AUTOCLAVE
134° C / 273° F**

		Ø	TL	Product no.
	<p>Light tube for MILOS method Ø 10 mm</p> <p>Instrument channel for 5 mm instruments</p>	10 mm	200 mm	893420

Recommended accessories	Product no.	
<p>Fiber light cable bndl consisting of: Fiber light cable Ø 5 mm, TL 2.3 m (80665023), projector-side adapter (8095.07), and endoscope-side adapter (809509)</p>	Ø 5.0 mm, 2.3 m long	806650231
<p>Fusion Fiber light cable bndl consisting of: Fiber light cable Ø 5 mm, TL 2.3 m (80655023), projector-side adapter (8095.07), and endoscope-side adapter (809509)</p>	Ø 5.0 mm, 2.3 m long	806550231
Sealing cap, sulfur yellow, cap. 1.3 mm		8934201



V124 || Subject to modifications. Please note that some products may not be available in all countries. Please always take note of the information that is provided with the product. For more detailed information, please consult with your contact partner or directly with Richard Wolf GmbH.

LAPAROSCOPES
ACCESSORIES

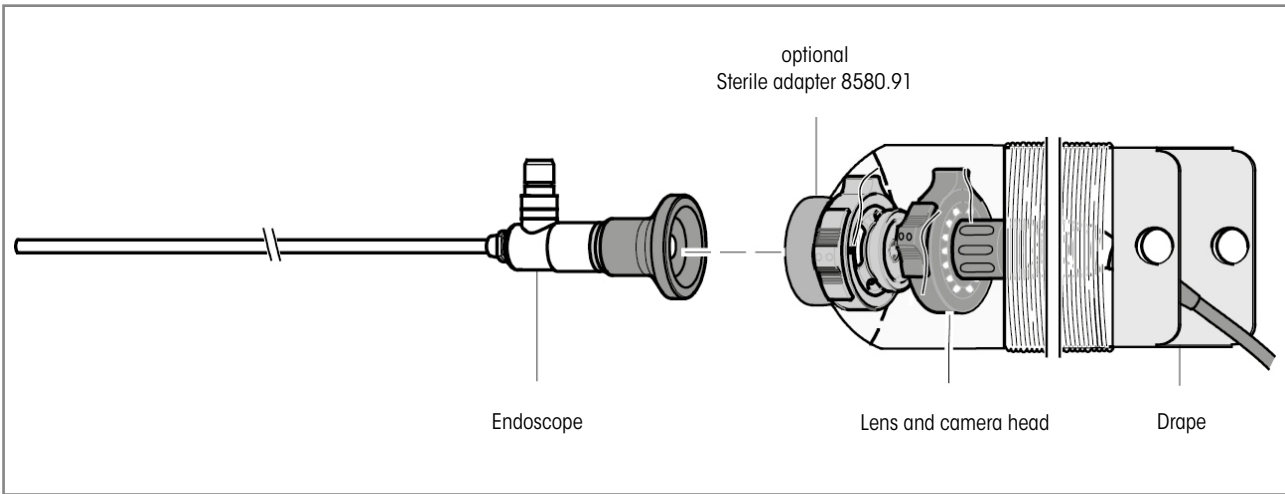
			Product no.
	Sterile adapter	immersible and autoclavable for changing telescopes	8580.91



TROCAR SLEEVES 2.2 / 2.5 MM







				Tip triangular	
				Trocar tip triangular Size 2.2 mm	
Plastic sheath tube with thread	WL	Capacity	Product no.	WL 82 mm	
Trocar sleeve capacity 2.2 mm WL 60 mm with universal sealing valve	 60 mm	2.2 mm	8309.072	8309.121	

Trocar sleeve with insufflation connector				Tip triangular	
				Trocar tip triangular Size 2.2 mm	
Stainless steel sheath tube, smooth	WL	Capacity	Product no.	WL 82 mm	
Trocar sleeve capacity 2.5 mm WL 55 mm	 55 mm	2.5 mm	8309.012	8309.121	
				WL 119 mm	
Trocar sleeve capacity 2.5 mm WL 95 mm	 95 mm	2.5 mm	8309.014	8309.123	

Accessories	Product no.
Rubber cap capacity 0.8 mm (PACK= 10 PCS) red	88.01

TROCAR SLEEVES 3.5 MM











WITH INSUFFLATION STOPCOCK

RIWO-ART trocar sleeves with magnetic ball valve with insufflation stopcock				Tip tapered/blunt	Tip triangular
					
				Trocar tip blunt Size 3.5 mm	Trocar tip triangular Size 3.5 mm
Stainless steel sheath tube, smooth	WL	Capacity	Product no.	WL 169 mm	WL 169 mm
Trocar sleeve straight capacity 3.5 mm WL 100 mm	 100 mm	3.5 mm	8903.014	8903.103	8903.123
Plastic sheath tube with thread					
Trocar sleeve straight capacity 3.5 mm WL 100 mm	 100 mm	3.5 mm	8903.034	8903.103	8903.123
				WL 129 mm	WL 129 mm
Trocar sleeve slanted capacity 3.5 mm WL 60 mm	 60 mm	3.5 mm	8903.072	8903.101	8903.121

Accessories	Product no.
Spare ball capacity 5.5 mm	8921.901
Spare O rings capacity 3.5 mm (PACK= 10 PCS), capacity Ø 3.5–5.5 mm	8921.951
Sealing cap capacity 2.4–3.4 mm (PACK= 10 PCS) red	89.01
Stopcock insert bndl cap. 3.0 mm (PACK= 5 PCS)	896.0002









Trocar sleeve with membrane valve				Tip tapered/blunt	
				Trocar tip blunt Size 3.5 mm	
Plastic sheath tube with distal screw anchor	WL	Capacity	Product no.	WL 169 mm	
Trocar sleeve straight capacity 3.5 mm WL 40 mm	 40 mm	3.5 mm	8929.223	8903.103	

TROCAR SLEEVES 5.5 MM

RIWO-ART trocar sleeves with magnetic ball valve with insufflation stopcock 				Tip tapered/blunt	Tip tapered/ pointed	Tip triangular
				 Trocar tip blunt Size 5.5 mm	 Trocar tip pointed Size 5.5 mm	 Trocar tip triangular Size 5.5 mm
Stainless steel sheath tube				WL 169 mm	WL 169 mm	WL 169 mm
Trocar sleeve straight capacity 5.5 mm WL 100 mm smooth 	100 mm	5.5 mm	8921.014	8921.103	8921.113	8921.123
Trocar sleeve slanted capacity 5.5 mm WL 100 mm smooth 	100 mm	5.5 mm	8921.013	8921.103	8921.113	8921.123
Trocar sleeve straight capacity 5.5 mm WL 100 mm with thread 	100 mm	5.5 mm	8921.024	8921.103	8921.113	8921.123
Trocar sleeve slanted capacity 5.5 mm WL 100 mm with thread 	100 mm	5.5 mm	8921.023	8921.103	8921.113	8921.123
Plastic tube Trocar sleeve straight capacity 5.5 mm WL 100 mm with thread 	100 mm	5.5 mm	8921.034	8921.103	8921.113	8921.123
				WL 219 mm	WL 219 mm	WL 219 mm
Trocar sleeve straight capacity 5.5 mm WL 150 mm smooth 	150 mm	5.5 mm	8921.016	8921.105	8921.115	8921.125
Trocar sleeve straight capacity 5.5 mm WL 150 mm with thread 	150 mm	5.5 mm	8921.026	8921.105	8921.115	8921.125

Accessories	Product no.
Spare ball capacity 5.5 mm	8921.901
Spare O rings capacity 3.5 mm (PACK= 10 PCS), capacity Ø 3.5–5.5 mm	8921.951
Sealing cap capacity 3.4–5.1 mm (PACK= 10 PCS) blue	89.02
Stopcock insert bndl cap. 3.0 mm (PACK= 5 PCS)	896.0002

TROCAR SLEEVES 5.5 MM





RIWO-ART trocar sleeves with magnetic ball valve 				Tip tapered/blunt	Tip tapered/pointed	Tip triangular
				Trocar tip blunt Size 5.5 mm	Trocar tip pointed Size 5.5 mm	Trocar tip triangular Size 5.5 mm
Stainless steel sheath tube	WL	Capacity	Product no.	WL 129 mm	WL 129 mm	WL 129 mm
Trocar sleeve straight capacity 5.5 mm WL 60 mm smooth 	60 mm	5.5 mm	8921.052	8921.101	8921.111	8921.121
Trocar sleeve slanted capacity 5.5 mm WL 60 mm smooth 	60 mm	5.5 mm	8921.051	8921.101	8921.111	8921.121
Trocar sleeve straight capacity 5.5 mm WL 60 mm with thread 	60 mm	5.5 mm	8921.062	8921.101	8921.111	8921.121
Trocar sleeve slanted capacity 5.5 mm WL 60 mm with thread 	60 mm	5.5 mm	8921.061	8921.101	8921.111	8921.121
Plastic tube Trocar sleeve straight capacity 5.5 mm WL 60 mm with thread 	60 mm	5.5 mm	8921.072	8921.101	8921.111	8921.121
				WL 169 mm	WL 169 mm	WL 169 mm
Trocar sleeve straight capacity 5.5 mm WL 100 mm smooth 	100 mm	5.5 mm	8921.054	8921.103	8921.113	8921.123
Trocar sleeve straight capacity 5.5 mm WL 100 mm with thread 	100 mm	5.5 mm	8921.053	8921.103	8921.113	8921.123

Accessories	Product no.
Spare ball capacity 5.5 mm	8921.901
Spare O rings capacity 3.5 mm (PACK= 10 PCS), capacity Ø 3.5–5.5 mm	8921.951
Sealing cap capacity 3.4–5.1 mm (PACK= 10 PCS) blue	89.02

TROTEC

TROCAR WITH AUTOMATIC PROTECTIVE FUNCTION

FOR TROCAR SLEEVES 5.5 MM

Trocar consisting of:		Product no.	for RIWO-ART trocar sleeve with WL 100 mm, Ø 5,5 mm
Sheath with trocar tip Size 5.5 mm WL 181 mm	Tapered tip 	8921.132	
Sheath with trocar tip Size 5.5 mm WL 181 mm	Two-sided tip 	8921.134	
Spring-loaded protective rod WL 184 mm		8923.135	

Accessories	Product no.
Protective cap	8923.991

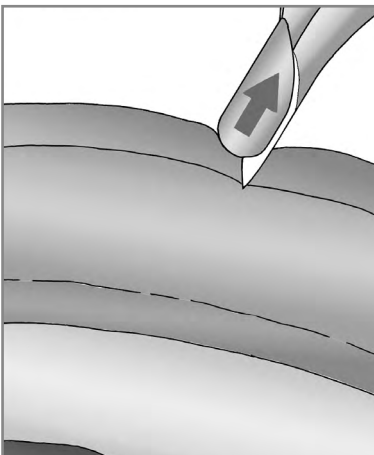

Protective tip automatically pushes back into the cannula through contact with the abdominal wall

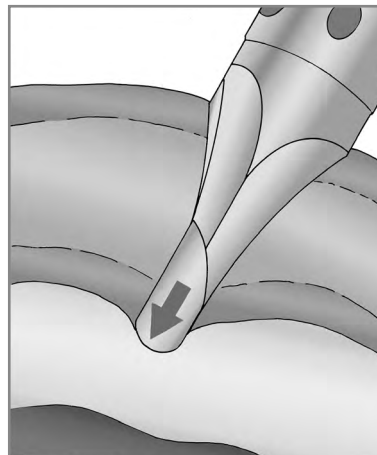

The protective tip advances into the free abdomen immediately after penetration of the peritoneum

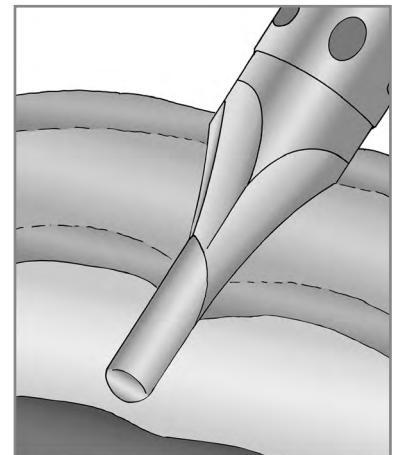





The atraumatic protective tip in a far distal position prevents perforation of organs and vessels





TROCAR SLEEVE 5.5 MM/5.8 MM

PLASTIC WITH SEALING MEMBRANE

TROCAR SLEEVES

3

 <p>AUTOCLAVE 134° C / 273° F</p>					Tip tapered/blunt	Tip tapered/pointed	Tip triangular
							
					Trocar tip blunt Size 5.5 mm	Trocar tip pointed Size 5.5 mm	Trocar tip triangular Size 5.5 mm
Flexible plastic sheath tube with thread	WL	Capacity	with stopcock	Product no.	WL 104 mm	WL 104 mm	WL 104 mm
Trocar sleeve straight capacity 5.5 mm WL 62 mm with membrane valve	62 mm	5.5 mm	●	8919.333	8919.3311	8919.3312	8919.3313
				8919.331			
					WL 144 mm	WL 144 mm	WL 144 mm
Trocar sleeve straight capacity 5.5 mm WL 102 mm with membrane valve	102 mm	5.5 mm	●	8919.353	8919.3511	8919.3512	8919.3513
				8919.351			

for curved instruments				Tip tapered/blunt	Tip tapered/pointed	Tip triangular	Tip tapered/blunt
 <p>AUTOCLAVE 134° C / 273° F</p>							
				Trocar tip blunt Size 5.5 mm	Trocar tip pointed Size 5.5 mm	Trocar tip triangular Size 5.5 mm	Trocar tip blunt Size 5.5 mm
Flexible plastic sheath tube with thread	WL	Capacity	Product no.	WL 80 mm	WL 80 mm	WL 80 mm	WL 80 mm
Trocar sleeve straight capacity 5.8 mm WL 62 mm with membrane valve	62 mm	5.8 mm	8905.331	8905.3311	8905.3312	8905.3313	8905.3315
				WL 120 mm	WL 120 mm	WL 120 mm	WL 120 mm
Trocar sleeve straight capacity 5.8 mm WL 102 mm with membrane valve	102 mm	5.8 mm	8905.3515	8905.3511	8905.3512	8905.3513	8905.3515

Accessories	Product no.
Sealing membrane Ø 17 mm, yellow (PACK= 10 PCS)	89.103
Stopcock insert bndl cap 3.0 mm (PACK= 5 PCS)	896.0002

V124 | Subject to modifications. Please note that some products may not be available in all countries. Please always take note of the information that is provided with the product. For more detailed information, please consult with your contact partner or directly with Richard Wolf GmbH.









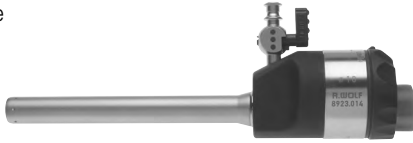

TROCAR SLEEVE 5.7 MM/7 MM/10 MM/12.5 MM

FLEXIBLE PLASTIC SHEATH TUBE

				Tip tapered/blunt
				Trocar tip blunt
Flexible plastic sheath tube with thread	WL	Capacity	Product no.	Size 5.5 mm/WL 83 mm
Trocar sleeve straight capacity 5.7 mm WL 60 mm with rubber cap	60 mm	5.7 mm	8906.051	8906.151

				Tip tapered/blunt
				Trocar tip blunt
Ribbed flexible plastic sheath tube	WL	Capacity	Product no.	Size 7.3 mm/TL 108 mm
Trocar sleeve flexible capacity 7 mm WL 74 mm with universal seal	74 mm	7 mm	8906.001	8913.11
				Size 10 mm/TL 85 mm
Trocar sleeve flexible capacity 10 mm WL 56 mm with universal seal	56 mm	10 mm	8906.011	8906.111
				Size 12.5 mm/TL 86 mm
Trocar sleeve flexible capacity 12.5 mm WL 57 mm with universal seal	57 mm	12.5 mm	8906.031	8906.131

TROCAR SLEEVE 10 MM WITH INSUFFLATION STOPCOCK





RIWO-ART trocar sleeves with magnetic ball valve 				Tip tapered/blunt 	Tip tapered/pointed 	Tip triangular 	
				Trocar tip blunt Size 10 mm	Trocar tip pointed Size 10 mm	Trocar tip triangular Size 10 mm	
Stainless steel sheath tube		WL	Capacity	Product no.	WL 164 mm	WL 164 mm	WL 164 mm
Trocar sleeve straight capacity 10 mm WL 100 mm 	100 mm	10 mm	8923.014	8923.103	8923.113	8923.123	
Trocar sleeve slanted capacity 10 mm WL 100 mm 	100 mm	10 mm	8923.013	8923.103	8923.113	8923.123	
Trocar sleeve straight capacity 10 mm WL 100 mm with thread 	100 mm	10 mm	8923.024	8923.103	8923.113	8923.123	
Trocar sleeve slanted capacity 10 mm WL 100 mm with thread 	100 mm	10 mm	8923.023	8923.103	8923.113	8923.123	
				WL 214 mm	WL 214 mm	WL 214 mm	
Trocar sleeve straight capacity 10 mm WL 150 mm 	150 mm	10 mm	8923.016	-	8923.115	8923.125	
Trocar sleeve straight capacity 10 mm WL 150 mm with thread 	150 mm	10 mm	8923.026	-	8923.115	8923.125	

Accessories	Product no.
Spare ball capacity 7 mm	8923901
Spare O rings capacity 7 mm (PACK= 10 PCS), capacity Ø 7–12.5 mm	8923951
Sealing cap capacity 9.5–10.1 mm (PACK= 10 PCS) red	8908
Stopcock insert bndl cap. 3.0 mm (PACK= 5 PCS)	896.0002

TROTEC

TROCAR WITH AUTOMATIC PROTECTIVE FUNCTION

FOR TROCAR SLEEVES 10 MM

			
Trocar consisting of:		Product no.	for RIWO-ART trocar sleeve with WL 100 mm, ø 10 mm
Sheath with trocar tip Size 10 mm WL 181 mm	Tapered tip 	8923.132	
Sheath with trocar tip Size 10 mm WL 181 mm	Two-sided tip 	8923.134	
Spring-loaded protective rod WL 184 mm		8923.135	

Accessories	Product no.
Protective cap	8923.991

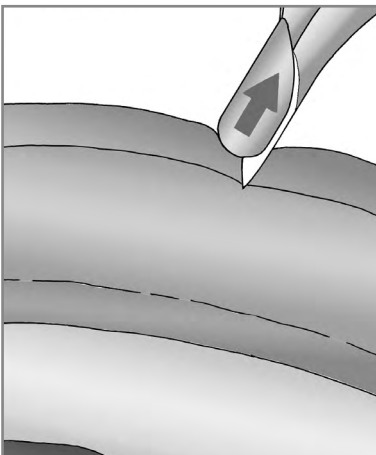

Protective tip automatically pushes back into the cannula through contact with the abdominal wall

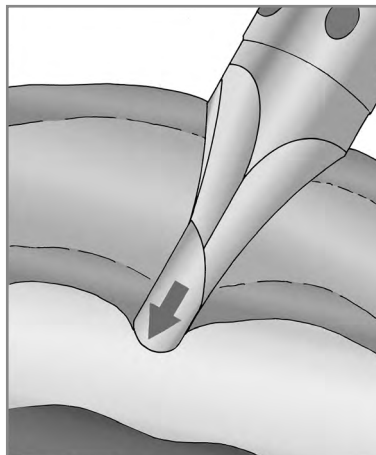

The protective tip advances into the free abdomen immediately after penetration of the peritoneum

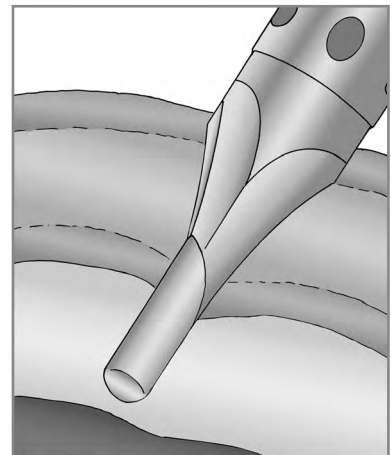



The atraumatic protective tip in a far distal position prevents perforation of organs and vessels

HIGH FLOW TROCAR SLEEVE 10 MM WITH CONNECTOR FOR HIGH FLOW INSUFFLATION TUBE

TROCAR SLEEVES

3







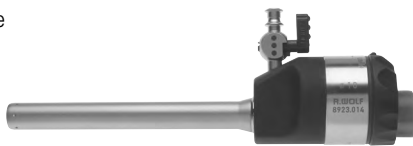

RIWO-ART trocar sleeves with magnetic ball valve 				Tip tapered/blunt	Tip tapered/pointed	Tip triangular		
								
				Trocar tip blunt Size 10 mm	Trocar tip pointed Size 10 mm	Trocar tip triangular Size 10 mm		
Stainless steel sheath tube		WL	Capacity	Product no.	WL 164 mm	WL 164 mm	WL 164 mm	
Trocar sleeve straight capacity 10 mm WL 100 mm			100 mm	10 mm	8923.042	8923.103	8923.113	8923.123
for this:						Product no.		
Reducing adapter (PACK= 5 PCS)			for reduction from Ø 7 mm, Ø 10 mm, and Ø 12.5 mm to Ø 5.5 mm			8923802		

Accessories	Product no.
Spare ball capacity 7 mm	8923901
Spare O rings capacity 7 mm (PACK= 10 PCS), capacity Ø 7–12.5 mm	8923951
Sealing cap capacity 9.5–10.1 mm (PACK= 10 PCS) red	8908

V124 || Subject to modifications. Please note that some products may not be available in all countries. Please always take note of the information that is provided with the product. For more detailed information, please consult with your contact partner or directly with Richard Wolf GmbH.

TROCAR SLEEVE 12.5 MM

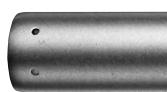
WITH INSUFFLATION STOPCOCK





RIWO-ART trocar sleeves with magnetic ball valve 				Tip tapered/blunt 	Tip tapered/pointed 	Tip triangular 	
				Trocar tip blunt Size 12.7 mm	Trocar tip pointed Size 12.7 mm	Trocar tip triangular Size 12.7 mm	
Stainless steel sheath tube		WL	Capacity	Product no.	WL 164 mm	WL 164 mm	WL 164 mm
Trocar sleeve straight capacity 12.5 mm WL 100 mm 	100 mm	12.5 mm	8924.014	8924.103	8924.113	8924.123	
Trocar sleeve slanted capacity 12.5 mm WL 100 mm 	100 mm	12.5 mm	8924.013	8924.103	8924.113	8924.123	
				WL 214 mm	WL 214 mm	WL 214 mm	
Trocar sleeve straight capacity 12.5 mm WL 150 mm with thread 	150 mm	12.5 mm	8924.026	-	8924.115	8924.125	
Trocar sleeve straight capacity 12.5 mm WL 150 mm 	150 mm	12.5 mm	8924.016	-	8924.115	8924.125	
for this:							
Reducing adapter (PACK= 5 PCS) 		for reduction from Ø 10 mm to Ø 5.5 mm and Ø 12.5 mm to Ø 5.5 mm			8923.802		
		for reduction from Ø 12.5 mm to Ø 10 mm			8924.802		

Accessories	Product no.
Spare ball capacity 7 mm	8923.901
Spare O rings capacity 7 mm (PACK= 10 PCS), capacity Ø 7–12.5 mm	8923.951
Sealing cap capacity 9.5–10.1 mm (PACK= 10 PCS) red	89.08
Stopcock insert bndl cap. 3.0 mm (PACK= 5 PCS)	896.0002

TROTEC
TROCAR WITH AUTOMATIC PROTECTIVE FUNCTION
 FOR TROCAR SLEEVES 12.5 MM

TROCAR SLEEVES

3

			
Trocar consisting of:		Product no.	for RIWO-ART trocar sleeve with WL 100 mm, Ø 12,5 mm
Sheath with trocar tip Size 12.5 mm WL 181 mm	Two-sided tip 	8924.134	
Spring-loaded protective rod WL 184 mm		8923.135	

Accessories	Product no.
Protective cap	8923.991

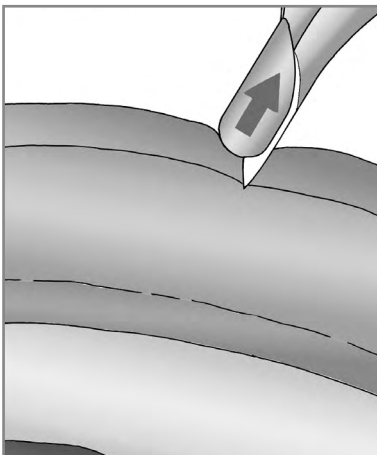

Protective tip automatically pushes back into the cannula through contact with the abdominal wall

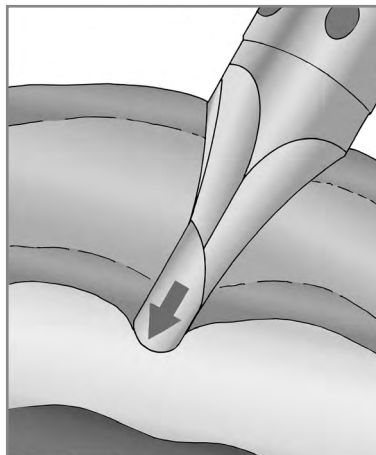

The protective tip advances into the free abdomen immediately after penetration of the peritoneum

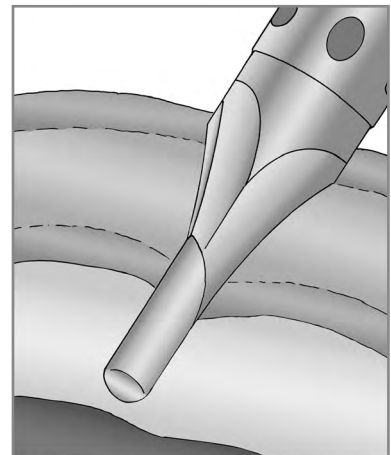

The atraumatic protective tip in a far distal position prevents perforation of organs and vessels

DILATATION AND EXTRACTION INSTRUMENTS

5.5 TO 10/10 TO 12.5 MM

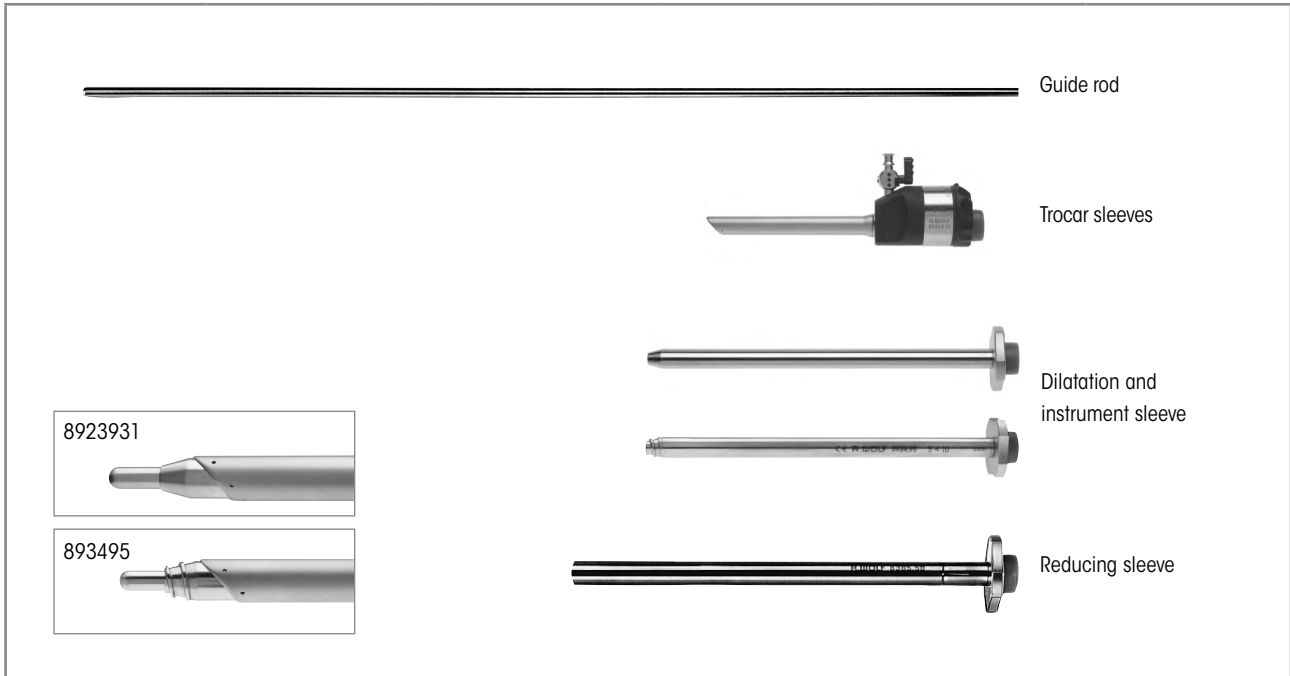

Incision widening	Guide rod	Trocar sleeve slanted	Dilatation sleeve	Instrument sleeve	Reducing sleeve
3.5 mm < 5.5 mm	-	8921.013 capacity 5.5 mm WL 100 mm			8383.78 Size 5 mm L 155 mm
5.5 mm < 10 mm	8923.921 5.5 mm TL 500 mm	8923.013 capacity 10 mm WL 100 mm	8923.931 Size 10 mm WL 170 mm	8385.50 10 mm WL 170 mm	
5.0 mm < 10 mm	8934.951 5 mm TL 500 mm		8934.95 Size 10 mm WL 172 mm		
10 mm < 12.5 mm		8924.013 capacity 12.5 mm WL 100 mm			8941.901 12 mm WL 180 mm
5.5 mm < 12.5 mm					8941.951 12 mm WL 180 mm
10 mm < 15 mm	8943.901 10 mm TL 500 mm				

V124 || Subject to modifications. Please note that some products may not be available in all countries. Please always take note of the information that is provided with the product. For more detailed information, please consult with your contact partner or directly with Richard Wolf GmbH.

REDUCING SLEEVES FOR RIWO-ART TROCAR SLEEVES

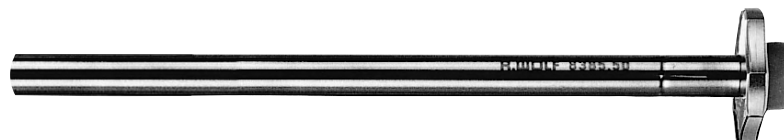



Stainless steel sheath tube	Outer Ø	WL	for instruments	Product no.
Reducing sleeve Size 5 mm WL 155 mm	5 mm	155 mm	3.5 mm	8383.78
Instrument sleeve 10 mm WL 170 mm	10 mm	170 mm	5.5 mm	8385.50
Reducing sleeve 12 mm WL 180 mm	12 mm	180 mm	10 mm	8941.901
Reducing sleeve 12 mm WL 180 mm	12 mm	180 mm	5.5 mm	8941.951
for this:				
Reducing adapter (PACK= 5 PCS)		for reduction from Ø 7 mm, Ø 10 mm, and Ø 12.5 mm to Ø 5.5 mm		8923802
		for reduction from Ø 12.5 mm to Ø 10 mm		8924802

Accessories	Product no.
Sealing cap capacity 3.4–5.1 mm (PACK= 10 PCS) blue	89.02
Sealing cap capacity 9.5–10.1 mm (PACK= 10 PCS) red	8908

VERES CANNULAS

FOR CREATION OF THE PNEUMOPERITONEUM

				
		Outer Ø	WL	Product no.
	VERES cannula Ø 2.1 mm WL 150 mm	2.1 mm	150 mm	8302.15
	VERES cannula Ø 2.1 mm WL 120 mm (standard length)		120 mm	8302.12
	VERES cannula Ø 2.1 mm WL 80 mm		80 mm	8302.08
for this:				
Tube with Luer-Lock connector				886.00

Accessories	Product no.
Stopcock insert bndl cap. 3.0 mm (PACK= 5 PCS)	896.0002

V124 || Subject to modifications. Please note that some products may not be available in all countries. Please always take note of the information that is provided with the product. For more detailed information, please consult with your contact partner or directly with Richard Wolf GmbH.

ERAGON^{modular}

THE LAPAROSCOPIC TOOLBOX

The toolbox principle

ERAGONmodular allows the surgeon to create their ideal laparoscopic set. Ergonomic handles, diameters relevant to all medical practice, useful working lengths, and a range of jaw sections can be combined as necessary. This universal compatibility also ensures that individual trays can comprise fewer instruments – for more efficiency and one way of cutting costs

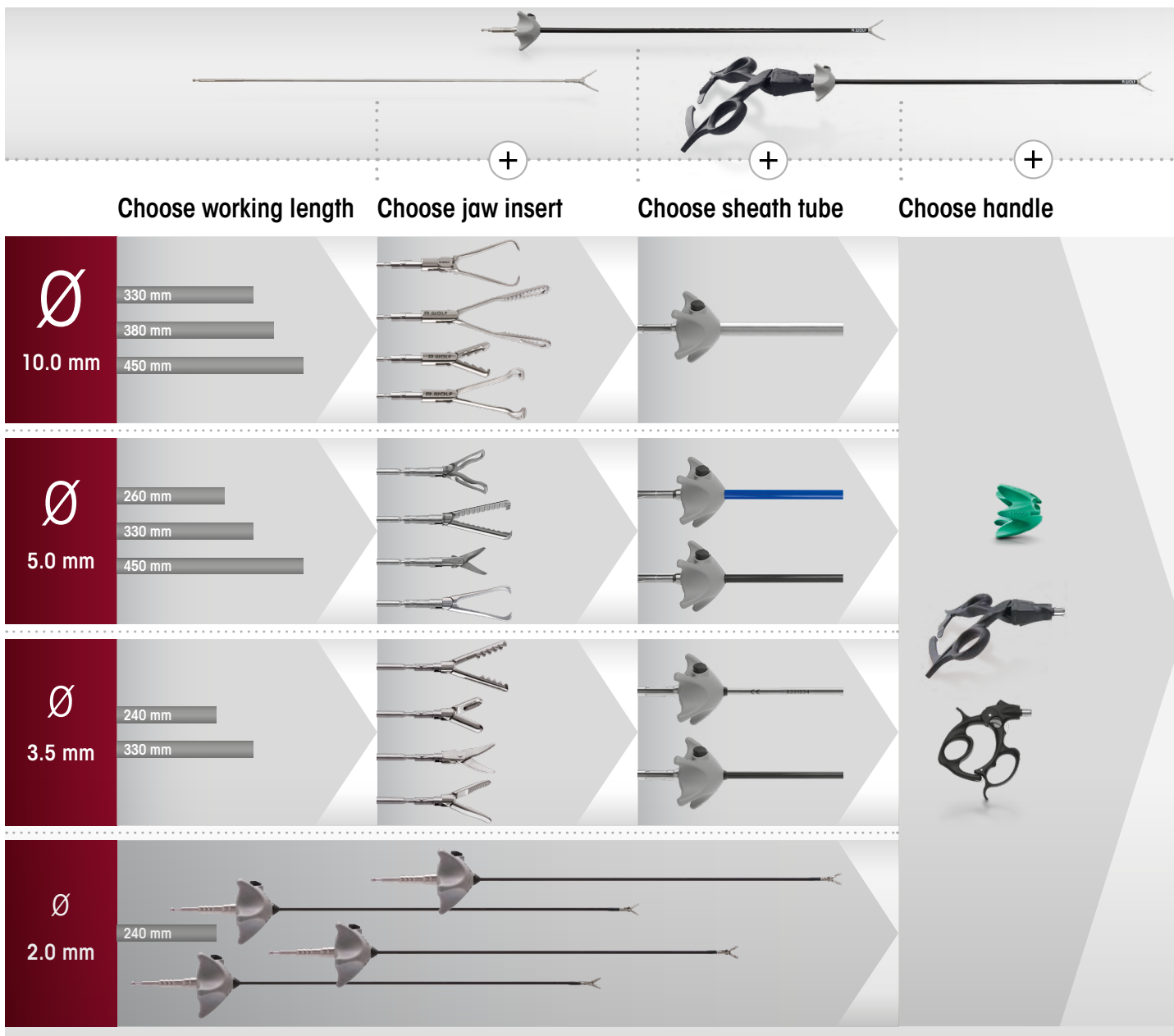

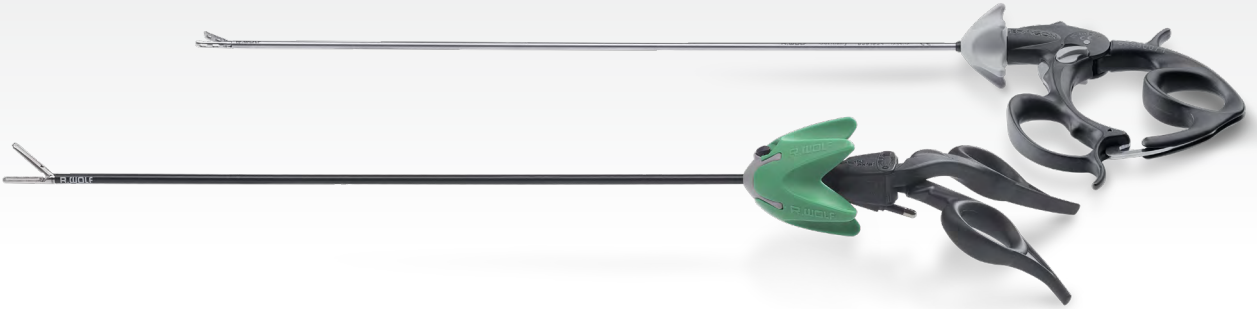



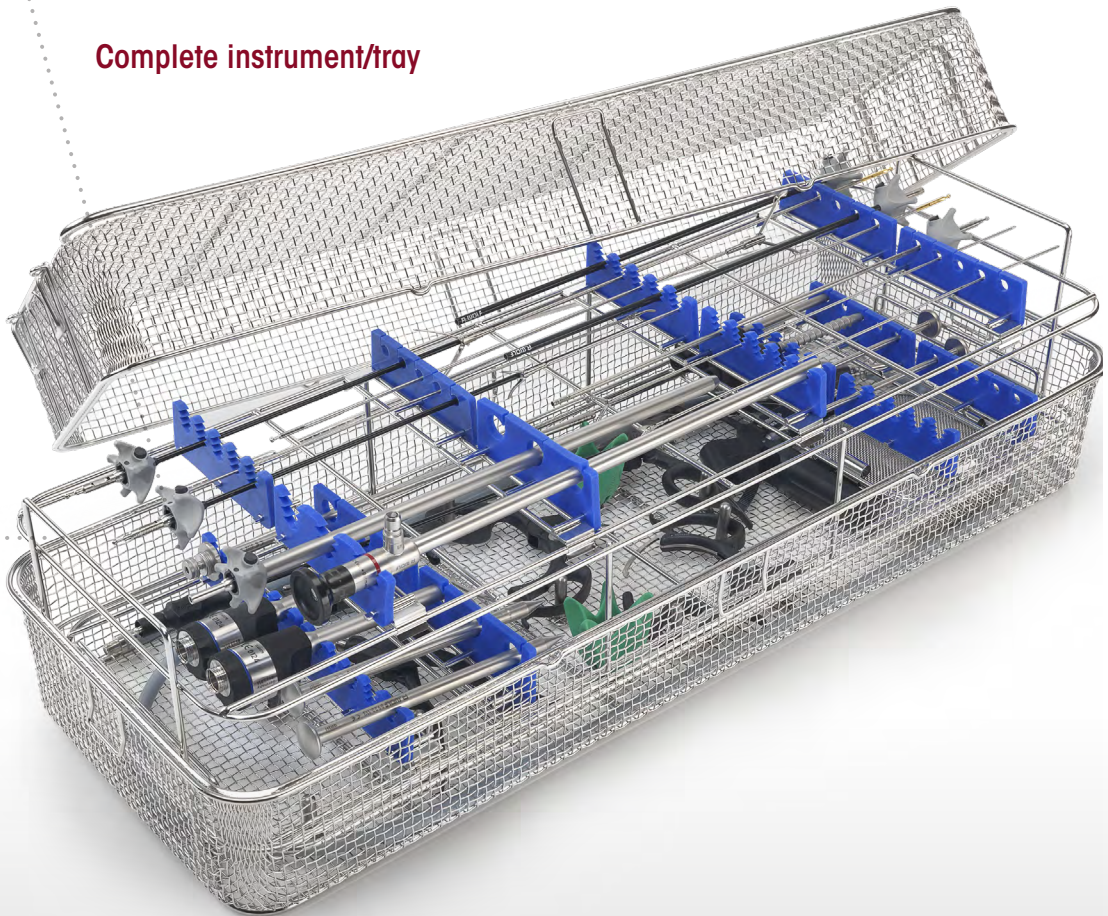





Complete instrument/tray







ERAGON *modular*
micro
Ø 2 MM, INSULATED

		Handle, axial	
ERAGON <i>axial</i>			
All jaw inserts and sheath tubes can also be combined with ERAGON axial		without lock, with HF connector	without lock, with HF connector
Rotatable knob	Product no.	83930083	83930084
	8988	•	•

Jaw insert			Sheath tube, Ø 2.0 mm, insulated	Handle, pistol-shaped	Complete instrument • Jaw insert with sheath tube • Handle
					
			WL 240 mm	without lock, with HF, mono	
	JL*	Product no.		83930073	Product no.
	7 mm	8388200	•	•	83882007
straight, double-action					
	7 mm	8388201	•	•	83882017
straight, double-action					
	7 mm	8388202	•	•	83882027
fenestrated, double-action					

* JL = jaw length when jaw section closed (approximate measurements)
HF connection cable: see sheet BDE116/117

ERAGON *modular*
micro
Ø 2 MM, INSULATED

Jaw insert		Sheath tube, Ø 2.0 mm, insulated		Handle, pistol-shaped	Complete instrument • Jaw insert with sheath tube • Handle
					
		WL 240 mm		with lock, with HF, mono	
	JL*	Product no.		83930074	Product no.
 Grasping forceps mono Ø 2 mm bndl double-action	7 mm	8388203	•	•	83882037

* JL = jaw length when jaw section closed (approximate measurements)
HF connection cable: see sheet BDE116/117

Accessories for manual and machine reprocessing		Product no.
	Irrigation adapter Ø 9 mm, length 64 mm	163502



V124 || Subject to modifications. Please note that some products may not be available in all countries. Please always take note of the information that is provided with the product. For more detailed information, please consult with your contact partner or directly with Richard Wolf GmbH.







ERAGON modular mini

Ø 3.5 MM, INSULATED

ERAGONMODULAR

4

		Handle, axial	
ERAGON axial			
All jaw inserts and sheath tubes can also be combined with ERAGON axial		without lock, with HF connector	without lock, with HF connector
Rotatable knob	Product no.	83930083	83930084
	8988	•	•









Jaw insert		Sheath tube, Ø 3.5 mm, insulated		Handle, pistol-shaped	Complete instrument	
					<ul style="list-style-type: none"> • Jaw insert with sheath tube • Handle 	
		WL 240 mm	WL 330 mm	with lock, with HF, mono		
	JL*	Product no.	8390933	8391933	83930074	Product no.
	15 mm	8390207	•		•	83902077
curved to the left, double-action		8391207		•	•	83912077
	18 mm	8390221	•		•	83902217
long, fine tip, double-action		8391221		•	•	83912217
	14 mm	8390222	•		•	83902227
short, fine tip, double-action		8391222		•	•	83912227
	14 mm	8390223	•		•	83902237
angled, double-action		8391223		•	•	83912237

* JL = jaw length when jaw section closed (approximate measurements)

HF connection cable: see sheet BDE116/117

ERAGON modular mini

Ø 3.5 MM, INSULATED





Jaw insert			Sheath tube, Ø 3.5 mm, insulated		Handle, pistol-shaped		Complete instrument • Jaw insert with sheath tube • Handle
							
			WL 240 mm	WL 330 mm	without lock, with HF, mono	with lock, with HF, mono	
	JL*	Product no.	8390933	8391933	83930073	83930074	Product no.
 Metzenbaum scissors mono Ø 3.5 mm bndl 16 mm double-action		8390215	•		•		83902157
		8391215		•	•		83912157
 Metzenbaum scissors mono Ø 3.5 mm bndl 14 mm fine-toothed, curved, double-action		8390224	•		•		83902247
		8391224		•	•		83912247
 Hook scissors mono Ø 3.5 mm bndl 8 mm single-action		8390227	•		•		83902277
		8391227		•	•		83912277
 Double spoon forceps mono Ø 3.5 mm bndl 12 mm		8390216	•			•	83902167
		8391216		•		•	83912167
 Friedel punch mono Ø 3.5 mm bndl 10 mm		8390217	•			•	83902177
		8391217		•		•	83912177







* JL = jaw length when jaw section closed (approximate measurements)

HF connection cable: see sheet BDE116/117

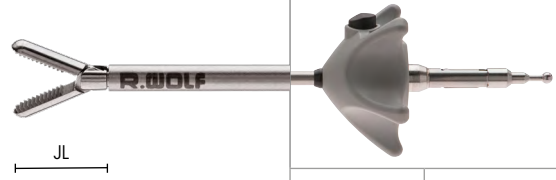
Accessories for manual and machine reprocessing		Product no.
	Irrigation adapter Ø 9 mm, length 64 mm	163502







ERAGON modular mini
Ø 3.5 MM, UNINSULATED

		Handle, axial	
 All jaw inserts and sheath tubes can also be combined with ERAGONaxial			
		with lock, without HF connector	with lock, without HF connector, not rotatable
Rotatable knob	Product no.	83930082	83930085
	8988	.	.

Jaw insert			Sheath tube, Ø 3.5 mm, uninsulated		Handle, pistol-shaped	Complete instrument • Jaw insert with sheath tube • Handle
 JL			WL 240 mm	WL 330 mm	 with lock, without HF	
			8390934	8391934		
 fenestrated, double-action	14 mm	8390208	.	.	.	83902087
		8391208	.	.	.	83912087
 fenestrated, single-action	17 mm	8390218	.	.	.	83902187
		8391218	.	.	.	83912187
 double fenestrated, curved, single-action	17 mm	8390225	.	.	.	83902257
		8391225	.	.	.	83912257
 fenestrated, double-action	19 mm	8390226	.	.	.	83902267
		8391226	.	.	.	83912267

* JL = jaw length when jaw section closed (approximate measurements)
 HF connection cable: see sheet BDE116/117

ERAGON modular
mini
Ø 3.5 MM, UNINSULATED

Jaw insert			Sheath tube, Ø 3.5 mm, uninsulated		Handle, pistol-shaped	Complete instrument • Jaw insert with sheath tube • Handle
			WL 240 mm	WL 330 mm	 with lock, without HF	
			Product no.	8390934		8391934
 Grasping forceps Ø 3.5 mm bndl 13 mm fenestrated, double-action	JL*	8390219	•		•	83902197
		8391219		•	•	83912197
 Grasping forceps Ø 3.5 mm bndl 17 mm fenestrated, single-action	JL*	8390220	•		•	83902207
		8391220		•	•	83912207
 Universal grasping forceps Ø 3.5 mm bndl 14 mm double-action	JL*	8390209	•		•	83902097
		8391209		•	•	83912097
 Babcock forceps Ø 3.5 mm bndl 19 mm double-action	JL*	8390210	•		•	83902107
		8391210		•	•	83912107

* JL = jaw length when jaw section closed (approximate measurements)







HF connection cable: see sheet BDE116/117







Accessories for manual and machine reprocessing		Product no.
	Irrigation adapter Ø 9 mm, length 64 mm	163503

ERAGON modular
Ø 5.0 MM, INSULATED

ERAGONMODULAR

4

		Handle, axial			
 All jaw inserts and sheath tubes can also be combined with ERAGONaxial					
		with lock	without lock, with HF connector	without lock, with HF connector	with lock, not rotatable
Rotatable knob	Product no.	83930082	83930083	83930084	83930085
	8988	•	•	•	







Jaw insert		Sheath tube, Ø 5.0 mm, insulated		Handle, pistol-shaped	Complete instrument	
					<ul style="list-style-type: none"> • Jaw insert with sheath tube • Handle 	
	JL*	Product no.	8393933	8394933	83930074	Product no.
	21 mm	8393.281	•		•	83932817
curved, with fine cross toothing, double-action		8394.281		•		•
	22 mm	8393.283	•		•	83932837
angled, fine, pyramid-shaped toothing, double-action						
	21 mm	8393.185	•		•	83931857
fenestrated, with fine cross toothing, 15 mm long, single-action						
	26 mm	8393.184	•		•	83931847
fenestrated, with fine cross toothing, 20 mm long, single-action		8394.184		•		•

* JL = jaw length when jaw section closed (approximate measurements)

HF connection cable: see sheet BDE116/117

V124 | Subject to modifications. Please note that some products may not be available in all countries. Please always take note of the information that is provided with the product. For more detailed information, please consult with your contact partner or directly with Richard Wolf GmbH.

ERAGON modular
Ø 5.0 MM, INSULATED

Jaw insert			Sheath tube, Ø 5.0 mm, insulated			Handle, pistol-shaped			Complete instrument • Jaw insert with sheath tube • Handle
			SL 260 mm	SL 330 mm	SL 450 mm	with lock, without HF	without lock, with HF, mono	with lock, with HF, mono	
	JL*	Product no.	8392933	8393933	8394933	83930072	83930073	83930074	Product no.
 Dolphin dissector forceps mono Ø 5 mm bndl angled, with fine cross-toothing, with channel, narrow, 15 mm long, double-action	17 mm	8393.285		•			•		83932857
 Dissector forceps mono Ø 5 mm bndl fine pyramid-shaped toothing, narrow, 18 mm, double-action	23 mm	8393.289		•				•	83932897
 Atraumatic grasping forceps Ø 5 mm bndl Channel with wavy tooth edge, 20 mm, single-action	26 mm	8393.292		•			•		83932925
 Atraumatic grasping forceps Ø 5 mm bndl Channel with wavy tooth edge, 20 mm, double-action	26 mm	8393.293		•			•		83932935
		8394.293			•		•		83942935
 Grasping forceps, mono Ø 5 mm bndl fine, pyramid-shaped toothing, narrow double-action	19 mm	8393.288		•				•	83932887
 Atraumatic grasping forceps mono Ø 5 mm bndl fenestrated, with cross toothing, double-action	19 mm	8392.181	•					•	83921817
		8393.181		•				•	83931817
		8394.181			•			•	83941817

* JL = jaw length when jaw section closed (approximate measurements)







HF connection cable: see sheet BDE116/117







V124 || Subject to modifications. Please note that some products may not be available in all countries. Please always take note of the information that is provided with the product. For more detailed information, please consult with your contact partner or directly with Richard Wolf GmbH.

ERAGON modular
Ø 5.0 MM, INSULATED

ERAGONMODULAR

4

		Handle, axial			
 All jaw inserts and sheath tubes can also be combined with ERAGONaxial					
		with lock	without lock, with HF connector	without lock, with HF connector	with lock, not rotatable
Rotatable knob	Product no.	83930082	83930083	83930084	83930085
	8988	•	•	•	

Jaw insert		Sheath tube, Ø 5.0 mm, insulated		Handle, pistol-shaped		Complete instrument	
						• Jaw insert with sheath tube • Handle	
	JL*	Product no.	SL 330 mm	SL 450 mm	with lock, without HF	without lock, with HF, mono	Product no.
 Atraumatic grasping forceps mono Ø 5 mm bndl 18 mm smooth, double-action	18 mm	8393.195	•			•	83931957
		8394.195		•			•
 Babcock forceps Ø 5 mm bndl 24 mm Gripping surface with fine cross tothing, double-action	24 mm	8393.186	•			•	83931867
		8393.187	•				•
 Babcock forceps Ø 5 mm bndl 26 mm large distal gripping surface with fine cross tothing, double-action	26 mm	8394.187		•		•	83941877
		8393.190	•				•
 Debakey forceps Ø 5 mm bndl 39 mm atraumatic clamp, double-action	39 mm	8393190	•			•	83931907









* JL = jaw length when jaw section closed (approximate measurements)

HF connection cable: see sheet BDE50 1710

V124 | Subject to modifications. Please note that some products may not be available in all countries. Please always take note of the information that is provided with the product. For more detailed information, please consult with your contact partner or directly with Richard Wolf GmbH.

ERAGON modular

Ø 5.0 MM, INSULATED

Jaw insert			Sheath tube, Ø 5.0 mm, insulated		Handle, pistol-shaped		Complete instrument • Jaw insert with sheath tube • Handle
							
			SL 330 mm	SL 450 mm	with lock, without HF	with lock, with HF, mono	
	JL*	Product no.	8393933	8394933	83930072	83930074	Product no.
 Debaque forceps Ø 5 mm bndl atraumatic clamp, double-action	48 mm	8393191	•		•		83931917
 Grasping forceps, mono Ø 5 mm bndl with a row of teeth, double-action	17 mm	8393.485	•			•	83934857
 Grasping forceps, mono Ø 5 mm bndl with one tooth, fine cross toothing, narrow, double-action	19 mm	8393.486	•			•	83934867
 Grasping forceps, mono Ø 5 mm bndl with two teeth, fine cross toothing, single-action	17 mm	8393.487	•			•	83934877
 Grasping forceps Ø 5 mm bndl with two teeth wavy gripping surface, double-action	26 mm	8393.490	•		•		83934907
		8394.490			•	•	83944907
 Petelin dissector forceps mono Ø 5 mm bndl angled 30° to the left, with cross toothing, single-action	17 mm	8393.282	•			•	83932827







* JL = jaw length when jaw section closed (approximate measurements)









HF connection cable: see sheet BDE116/117

ERAGON modular
Ø 5.0 MM, INSULATED

ERAGONMODULAR

4







		Handle, axial			
 All jaw inserts and sheath tubes can also be combined with ERAGONaxial					
		with lock	without lock, with HF connector	without lock, with HF connector	with lock, not rotatable
Rotatable knob	Product no.	83930082	83930083	83930084	83930085
	8988	•	•	•	

Jaw insert		Sheath tube, Ø 5.0 mm, insulated	Handle, pistol-shaped			Complete instrument	
		 SL 330 mm	 with lock, without HF	 without lock, with HF, mono	 with lock, with HF, mono	• Jaw insert with sheath tube • Handle	
	JL*	Product no.	8393933	83930072	83930073	83930074	Product no.
 Plate-shaped grasping forceps mono Ø 5 mm bndl fenestrated with fine cross tothing, double-action	18 mm	8393.182	•			•	83931827
 Grasping forceps mono Ø 5 mm bndl with cross tothing, double-action	21 mm	8393.183	•		•		83931837
 Grasping forceps mono Ø 5 mm bndl distal cross tothing with channel, double-action	15 mm	8393.287	•		•		83932877
 Claw grasping forceps Ø 5 mm bndl double-action	27 mm	8393.494	•	•			83934945

* JL = jaw length when jaw section closed (approximate measurements)

HF connection cable: see sheet BDE116/117

ERAGON modular
Ø 5.0 MM, INSULATED

Jaw insert			Sheath tube, Ø 5.0 mm, insulated		Handle, pistol-shaped			Complete instrument • Jaw insert with sheath tube • Handle
			SL 330 mm	SL 450 mm	with lock, without HF	without lock, with HF, mono	with lock, with HF, mono	
	JL*	Product no.	8393933	8394933	83930072	83930073	83930074	Product no.
 Myoma grasping forceps Ø 5 mm bndl 2x3-claw, single-action	29 mm	8393.488	•		•			83934887
 Universal grasping forceps mono Ø 5 mm bndl with pyramid-shaped toothing and cross toothing, double-action	18 mm	8393.481	•				•	83934817
 Universal grasping forceps Ø 5 mm bndl pyramid-shaped toothing and cross toothing, double-action	26 mm	8393.482	•		•			83934827
 Grasping forceps mono Ø 5 mm bndl Pike-mouth, double-action	20 mm	8393.483	•				•	83934837
 Biopsy forceps mono Ø 5 mm bndl with spikes, double-action	13 mm	8393.091	•				•	83930917
		8394.091		•		•		83940917
 Biopsy forceps mono Ø 5 mm bndl severing, single-action	14 mm	8393.092	•				•	83930927
		8394.092		•		•		83940927







* JL = jaw length when jaw section closed (approximate measurements)









HF connection cable: see sheet BDE116/117

ERAGON modular
Ø 5.0 MM, INSULATED

ERAGONMODULAR

4

		Handle, axial			
 All jaw inserts and sheath tubes can also be combined with ERAGONaxial					
		with lock	without lock, with HF connector	without lock, with HF connector	with lock, not rotatable
Rotatable knob	Product no.	83930082	83930083	83930084	83930085
	8988	•	•	•	

Jaw insert			Sheath tube, Ø 5.0 mm, insulated		Handle, pistol-shaped		Complete instrument • Jaw insert with sheath tube • Handle
							
	JL*	Product no.	SL 330 mm	SL 450 mm	with lock, without HF	without lock, with HF, mono	Product no.
 Biopsy forceps mono Ø 5 mm bndl	20 mm	8393.093	•			•	83930937
 Knot pusher Ø 5 mm bndl	17 mm	8393.345	•		•		83933457
		8394.345		•			83943457
 Grasping forceps Ø 5 mm bndl	37 mm	8393.188	•		•		83931887
 Grasping forceps Ø 5 mm bndl	47 mm	8393.189	•		•		83931897
		8394.189		•	•		83941897







* JL = jaw length when jaw section closed (approximate measurements)

HF connection cable: see sheet BDE116/117

V124 | Subject to modifications. Please note that some products may not be available in all countries. Please always take note of the information that is provided with the product. For more detailed information, please consult with your contact partner or directly with Richard Wolf GmbH.

ERAGON modular

Ø 5.0 MM, INSULATED

Jaw insert			Sheath tube, Ø 5.0 mm, insulated		Handle, pistol-shaped		Complete instrument • Jaw insert with sheath tube • Handle
			SL 330 mm	SL450 mm	with lock, without HF	with lock, with HF, mono	
	JL*	Product no.	8393933	8394933	83930072	83930074	Product no.
 Debaquey forceps Ø 5 mm bndl	47 mm	8393.291	•		•		83932917
atraumatic, spring jaw sections with cross toothing, double-action							
 Dissector forceps mono Ø 5 mm bndl	18 mm	8393192	•			•	83931927
angled, double-action				•		•	83941927
 Grasping forceps, mono Ø 5 mm bndl	16 mm	8393193	•		•		83931937
double-action				•	•		83941937
 Dissector forceps mono Ø 5 mm bndl	24 mm	8393194	•			•	83931947
double-action				•		•	83941947
 Dissector forceps mono Ø 5 mm bndl	30 mm	8393197	•			•	83931977
double-action				•		•	83941977
 Dissector forceps mono Ø 5 mm bndl	33 mm	8393198	•			•	83931987
fine tips double-action				•		•	83941987

* JL = jaw length when jaw section closed (approximate measurements)







HF connection cable: see sheet BDE116/117







V124 || Subject to modifications. Please note that some products may not be available in all countries. Please always take note of the information that is provided with the product. For more detailed information, please consult with your contact partner or directly with Richard Wolf GmbH.

ERAGON^{modular}
 Ø 5.0 MM, INSULATED

ERAGONMODULAR

4









		Handle, axial			
 All jaw inserts and sheath tubes can also be combined with ERAGONaxial					
		with lock	without lock, with HF connector	without lock, with HF connector	with lock, not rotatable
Rotatable knob	Product no.	83930082	83930083	83930084	83930085
	8988	•	•	•	

Jaw insert		Sheath tube, Ø 5.0 mm, insulated		Handle, pistol-shaped	Complete instrument	
					• Jaw insert with sheath tube • Handle	
		SL 330 mm	SL 450 mm	with lock, with HF, mono		
	JL*	Product no.	8393933	8394933	83930074	Product no.
 32 mm double-action		8393199	•		•	83931997
		8394199		•		•
 19 mm fine tip, double-action		8393200	•		•	83932007
		8394200		•		•
 16 mm atraumatic, with cross toothing, double-action		8393210	•		•	83932107
 19mm atraumatic, with cross toothing, double-action		8393220	•		•	83932207
		8394220		•		•

* JL = jaw length when jaw section closed (approximate measurements)
 HF connection cable: see sheet BDE116/117

V124 | Subject to modifications. Please note that some products may not be available in all countries. Please always take note of the information that is provided with the product. For more detailed information, please consult with your contact partner or directly with Richard Wolf GmbH.

ERAGON modular
Ø 5.0 MM, INSULATED

Jaw insert			Sheath tube, Ø 5.0 mm, insulated		Handle, pistol-shaped		Complete instrument • Jaw insert with sheath tube • Handle
							
			SL 330 mm	SL 450 mm	with lock, without HF	with lock, with HF, mono	
	JL*	Product no.:	8393933	8394933	83930072	83930074	Product no.:
 Atraumatic grasping forceps Ø 5 mm bndl 29 mm atraumatic, with pyramid-shaped tothing and cross tothing, double-action		8393223	•		•		83932237
		8394223		•	•		83942237
 Atraumatic grasping forceps Ø 5 mm bndl 25 mm atraumatic, single fenestrated with cross tothing, double-action		8393250	•		•		83932507
		8394250		•	•		83942507
 Atraumatic grasping forceps Ø 5 mm bndl 32 mm atraumatic, double fenestrated and curved single-action		8393229	•		•		83932297
		8394229		•	•		83942297
 Grasping forceps Ø 5 mm bndl 15 mm atraumatic, narrow and rounded, double-action		8393230	•		•		83932307
		8394230		•	•		83942307
 Dissector forceps mono Ø 5 mm bndl 19 mm curved, double-action		8393240	•			•	83932407
		8394240		•		•	83942407
 Dissector forceps mono Ø 5 mm bndl 17 mm single fenestrated double-action		8393242	•		•		83932427
		8394242		•	•		83942427

* JL = jaw length when jaw section closed (approximate measurements)
HF connection cable: see sheet BDE116/117







V124 || Subject to modifications. Please note that some products may not be available in all countries. Please always take note of the information that is provided with the product. For more detailed information, please consult with your contact partner or directly with Richard Wolf GmbH.







ERAGON modular

Ø 5.0 MM, INSULATED

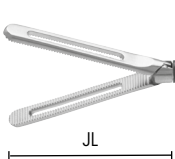
ERAGONMODULAR





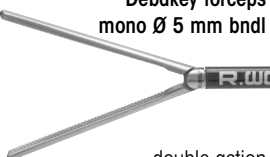



4

		Handle, axial			
 All jaw inserts and sheath tubes can also be combined with ERAGONaxial					
		with lock	without lock, with HF connector	without lock, with HF connector	with lock, not rotatable
Rotatable knob	Product no.	83930082	83930083	83930084	83930085
	8988	•	•	•	

Jaw insert		Sheath tube, Ø 5.0 mm, insulated		Handle, pistol-shaped		Complete instrument • Jaw insert with sheath tube • Handle	
							
	JL*	Product no.	SL 330 mm	SL 450 mm	with lock, without HF	with lock, with HF, mono	Product no.
 Intestine grasping forceps Ø 5 mm bndl atraumatic, single fenestrated with cross tooting, double-action	38 mm	8393249	•		•		83932497
		8394249		•	•		83942497
 Debakey forceps mono Ø 5 mm bndl curved, double-action	35 mm	8393256	•			•	83932567
	 Debakey forceps mono Ø 5 mm bndl double-action	47 mm	8393258	•			•
		8394258		•		•	83942587

* JL = jaw length when jaw section closed (approximate measurements)
 HF connection cable: see sheet BDE116/117

ERAGON modular
Ø 5.0 MM, INSULATED

Jaw insert			Sheath tube, Ø 5.0 mm, insulated		Handle, pistol-shaped	Complete instrument • Jaw insert with sheath tube • Handle
						
			SL 330 mm	SL 450 mm	without lock, with HF, mono	
	JL*	Product no.	8393933	8394933	83930073	Product no.
 Metzenbaum scissors mono Ø 5 mm bndl	23 mm	8393.041	•		•	83930417
		8394.041		•	•	83940417
 Metzenbaum micro scissors mono Ø 5 mm bndl	18 mm	8393.044	•		•	83930447
 Scissors mono Ø 5 mm bndl	20 mm	8393.045	•		•	83930457
 Hook scissors mono Ø 5 mm bndl	14 mm	8393.081	•		•	83930817
		8394.081		•	•	83940817
 Metzenbaum micro scissors mono Ø 5 mm bndl	21 mm	8393243	•		•	83932437
		8394243		•	•	83942437
 Scissors mono Ø 5 mm bndl	26 mm	8393246	•		•	83932467
		8394246		•	•	83942467







* JL = jaw length when jaw section closed (approximate measurements)







HF connection cable: see sheet BDE116/117

ERAGON^{modular}
 Ø 5.0 MM, INSULATED

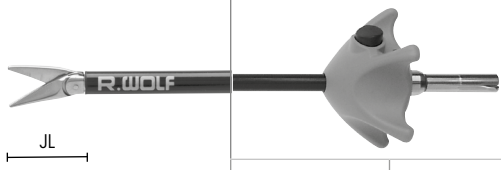
ERAGONMODULAR

4

		Handle, axial			
 All jaw inserts and sheath tubes can also be combined with ERAGONaxial					
		with lock	without lock, with HF connector	without lock, with HF connector	with lock, not rotatable
Rotatable knob	Product no.	83930082	83930083	83930084	83930085
	8988	•	•	•	



Jaw insert		Sheath tube, Ø 5.0 mm, insulated		Handle, pistol-shaped		Complete instrument
 JL						• Jaw insert with sheath tube • Handle
		SL 330 mm	SL 450 mm	with lock, without HF	without lock, with HF, mono	
	JL*	Product no.				Product no.
 Scissors mono Ø 5 mm bndl 22 mm		8393248	•		•	83932487
	fine-toothed, fine tip double-action	8394248		•	•	83942487
 Knot pusher Ø 5 mm bndl 17 mm		8393.345	•		•	83933457
	with distal recess, double-action	8394345		•	•	83943457
 Gastric band manipulator Ø 5 mm bndl 47 mm		8393253	•		•	83932537
	90° articulating with distal slot	8394253		•	•	83942537

* JL = jaw length when jaw section closed (approximate measurements)

HF connection cable: see sheet BDE116/117

Accessories for manual and machine reprocessing		Product no.
	Irrigation adapter Ø 9 mm, length 64 mm	163502

ERAGON^{modu} blades
 Ø 5.0 MM, INSULATED

 All jaw inserts and sheath tubes can also be combined with ERAGONaxial		Handle, axial 	
		without lock, with HF connector	
Rotatable knob	Product no.	83930083	
	8988	•	

Scissors attachment	Tension rod Ø 5.0 mm			Sheath tube insulated Ø 5.0 mm			Handle pistol-shaped	Complete instrument	
								<ul style="list-style-type: none"> Jaw insert with sheath tube Handle 	
	for SL 260 mm	for SL 330 mm	for SL 450 mm	SL 240 mm	SL 310 mm	SL 430 mm	without lock, rotatable with HF connector		
	Product no.	8392934	8393934	8394934	8392935	8393935	8394935	83930073	Product no.
Metzenbaum scissors attachment mono		•			•			•	83920407
	4393040		•			•		•	83930407
(PACK= 10 PCS), sterile, disposable				•			•	•	83940407





HF connection cable: see sheet BDE116/117







V124 || Subject to modifications. Please note that some products may not be available in all countries. Please always take note of the information that is provided with the product. For more detailed information, please consult with your contact partner or directly with Richard Wolf GmbH.

ERAGON modular
Ø 10 MM, UNINSULATED

ERAGONMODULAR

4



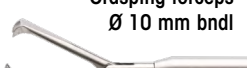



		Handle, axial	
ERAGON axial			
All jaw inserts and sheath tubes can also be combined with ERAGON axial		with lock, without HF connector	with lock, without HF connector, not rotatable
Rotatable knob	Product no.	83930082	83930085
	8988	.	.

Jaw insert		Sheath tube, Ø 10.0 mm, uninsulated		Handle, pistol-shaped	Complete instrument	
					<ul style="list-style-type: none"> Jaw insert with sheath tube Handle 	
		SL 327 mm	SL 447 mm	with lock, without HF		
	JL*	Product no.	8395902	8396902	83930072	Product no.
	36 mm	8395.225	.	.	.	83952257
double-action		8396225	.	.	.	83962257
	35 mm	8395.226	.	.	.	83952268
angled, double-action		8396226	.	.	.	83962267
	20 mm	8395.236	.	.	.	83952368
Pike-mouth double-action		8396236	.	.	.	83962367
	49 mm	8395.204	.	.	.	83952048
2/3 jaws single-action		8396204	.	.	.	83962047

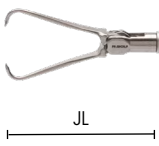
* JL = jaw length when jaw section closed (approximate measurements)
HF connection cable: see sheet BDE116/117

V124 || Subject to modifications. Please note that some products may not be available in all countries. Please always take note of the information that is provided with the product. For more detailed information, please consult with your contact partner or directly with Richard Wolf GmbH.

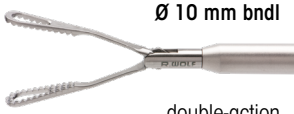

ERAGON modular
Ø 10 MM, UNINSULATED



Jaw insert			Sheath tube, Ø 10.0 mm, uninsulated			Handle, pistol-shaped		Complete instrument • Jaw insert with sheath tube • Handle
			SL 327 mm	SL 447 mm	SL 387 mm	with lock, without HF		
	JL*	Product no.	8395902	8396902	8397902	83930072	83930082	Product no.
 Claw grasping forceps Ø 10 mm bndl double-action	38 mm	8395.489	•			•		83954897
 Claw grasping forceps Ø 10 mm bndl with additional row of teeth, double-action	38 mm	8395490	•			•		83954907
 Babcock forceps Ø 10 mm bndl large distal gripping surface with fine cross toothing, double-action	42 mm	8395.187	•			•		83951877
		8396187		•		•		83961877
 Babcock forceps Ø 10 mm bndl double-action	38 mm	8395.214	•			•		83952148
 Plate-shaped grasping forceps Ø 10 mm bndl double-action	50 mm	8395.234	•			•		83952347
		8396234		•		•		83962347
 Spoon forceps Ø 10 mm bndl single-action	31 mm	8395.244	•			•		83952448
 Stapler head grasping forceps Ø 10 mm bndl angled 30°, double-action		8397.655			•		•	83976558



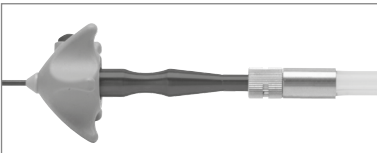

* JL = jaw length when jaw section closed (approximate measurements)/HF connection cable: see sheet BDE116/117

V124 || Subject to modifications. Please note that some products may not be available in all countries. Please always take note of the information that is provided with the product. For more detailed information, please consult with your contact partner or directly with Richard Wolf GmbH.

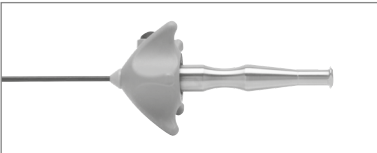
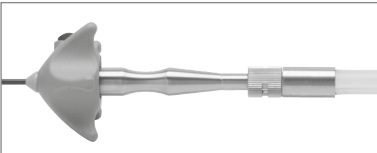
ERAGON modular
ACCESSORIES

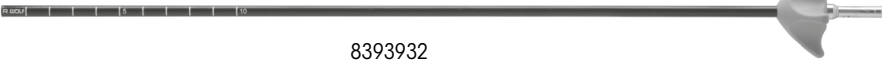



For insulated sheath tubes		Product no.
	For manual and machine reprocessing: Irrigation adapter Ø 9 mm, length 64 mm for insulated sheath tubes	163502
		





For uninsulated sheath tubes		Product no.
	For manual and machine reprocessing: Irrigation adapter cleaning Ø 9 mm, length 64 mm for uninsulated sheath tubes	163503
		



	8393932	
	8394932	

		Ø	SL	Product no.
ERAGONmodular	Sheath tube insulated Ø 5 mm SL 330 mm with distal cm scale	5 mm	330 mm	8393932
	Sheath tube insulated Ø 5 mm SL 450 mm with distal cm scale	5 mm	450 mm	8394932

HANDLE VARIANTS FOR MODULAR SYSTEMS

Handle, pistol-shaped 	rotatable	with lock	without lock	with HF	without HF	Product no.
	•	•			•	83930072
	•		•	•		83930073
	•	•		•		83930074

Handle, axial 	rotatable	with lock	without lock	with HF	without HF	Product no.
	•	•			•	83930082
	•		•	•		83930083
	•	•		•		83930084
		•			•	83930085

Optional for 83930082/83930083/83930084:		Product no.
 	Rotatable knob autoclavable	8988

All ERAGON modular components are compatible with ERAGON axial

CHOLANGIOGRAPHY CATHETERGRASPING FORCEPS 5 MM

FORCEPS

5

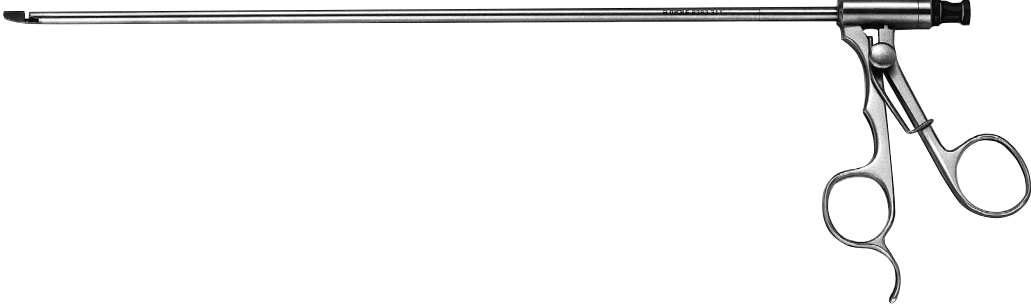







		Outer Ø	WL	Product no.
	Grasping forceps Ø 5 mm WL 295 mm	5.0 mm	295 mm	8383.311

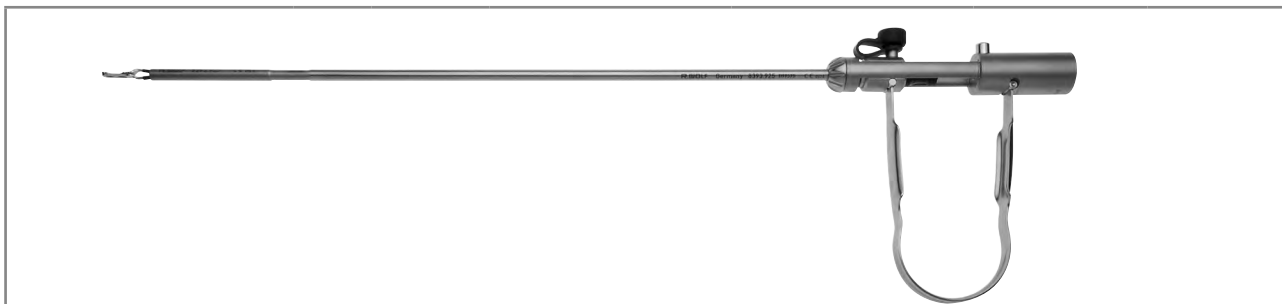

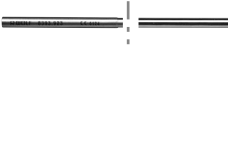

- For inserting a cholangiography catheter up to 7 Fr into the cystic duct

BIPOLAR FORCEPS 3.5 MM/5.0 MM

WITH SPRING HANDLE
MODULAR SYSTEM

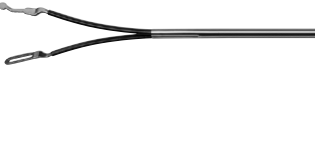
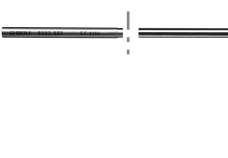

Grasping forceps jaw insert			Outer tube Ø 3.5 mm SL 348 mm	Screw cap with sleeve Ø 5.0 mm SL 107 mm	Spring handle bipo	complete instrument • Jaw insert • Sliding sleeve • Outer tube • Spring handle
						
	JL*	Product no.	8391.921	8393.978	8393.975	Product no.
	39 mm	8391.715	•	•	•	8391.742







Kleppinger grasping forceps jaw insert			Sliding sleeve SL 319 mm	Outer tube Ø 5 mm SL 237 mm	Spring handle bipo	complete instrument • Jaw insert • Sliding sleeve • Outer tube • Spring handle
						
	JL*	Product no.	8393.923	8393.925	8393.975	Product no.
	53 mm	8393.714	•	•	•	8393.741

Accessories	Product no.
RIWO rubber cap, jet black	15220.019
Luer sealing cap	15023.153

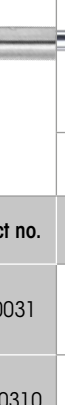
* JL = jaw length when jaw section closed (approximate measurements)
Bipolar connection cable: see sheet BDE118/119

V124 || Subject to modifications. Please note that some products may not be available in all countries. Please always take note of the information that is provided with the product. For more detailed information, please consult with your contact partner or directly with Richard Wolf GmbH.





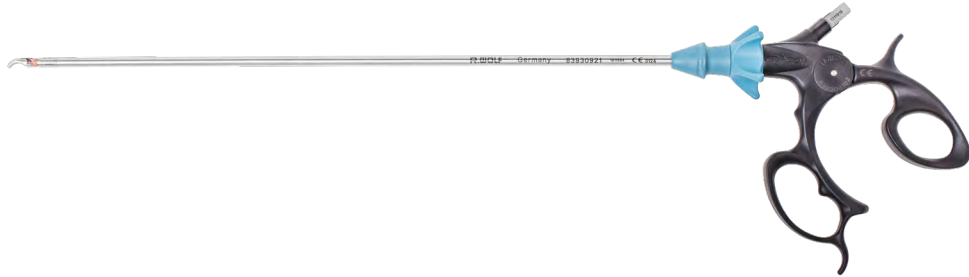

ERAGON bipolar
MODULAR BIPOLAR INSTRUMENTS, 5.5 MM
ROTATABLE

		Jaw insert		Sheath tube Ø 5.5 mm		Handle, pistol-shaped, bipo	Complete instrument • Jaw insert • Sheath tube • Handle
							
				SL 320 mm	SL 435 mm	rotatable	
		JL*	Product no.	83930921	82340024	839300102	Product no.
	Grasping forceps bipo Ø 5.5 mm bndl	21 mm	83930031	•		•	839300312
			839400310		•	•	839400312
	Maryland dissector bipo Ø 5.5 mm bndl	23 mm	83930032	•		•	839300322
			839400320		•	•	839400322
	Dolphin dissector bipo Ø 5.5 mm bndl	21 mm	83930033	•		•	839300332
			839400330		•	•	839400332
	Grasping forceps bipo Ø 5.5 mm bndl	23 mm	83930034	•		•	839300342
			839400340		•	•	839400342
	Preparation forceps bipo Ø 5.5 mm bndl	19 mm	83930035	•		•	839300352
			839400350		•	•	839400352

* JL = jaw length when jaw section closed (approximate measurements)
Bipolar connection cable: see sheet BDE118/119

ERAGON bipolar
MODULAR BIPOLAR INSTRUMENTS, 5.5 MM,
ROTATABLE



Jaw insert		Sheath tube Ø 5.5 mm		Handle, pistol-shaped, bipo	Complete instrument • Jaw insert • Sheath tube • Handle	
						
		SL 320 mm	SL 435 mm	rotatable		
	JL*	Product no.	83930921	82340024	839300102	Product no.
	22 mm	83930037	•		•	839300372
	15 mm	83930038	•		•	839300382
		839400380		•	•	839400382
	22 mm	83930041	•		•	839300412
		839400410		•	•	839400412

* JL = jaw length when jaw section closed (approximate measurements)
Bipolar connection cable: see sheet BDE118/119

V124 || Subject to modifications. Please note that some products may not be available in all countries. Please always take note of the information that is provided with the product. For more detailed information, please consult with your contact partner or directly with Richard Wolf GmbH.





ELECTRODES 2.0 MM/3.5 MM

MONOPOLAR



		Outer Ø	WL	Product no.
	Coagulation electrode mono 5 Fr WL 400 mm	1.67 mm	400 mm	823.05
	Coagulation electrode mono 6 Fr WL 400 mm	2.0 mm	400 mm	823.06





		Outer Ø	WL	Product no.
	Hook electrode mono Ø 3.5 mm WL 310 mm	3.5 mm	310 mm	8379.452
	Hook electrode mono Ø 3.5 mm WL 240 mm with distally extended insulation	3.5 mm	240 mm	8785.642
	Needle electrode mono Ø 3.5 mm WL 310 mm	3.5 mm	310 mm	8379.482
	Coagulation electrode mono Ø 3.5 mm WL 310 mm	3.5 mm	310 mm	8379.462

HF connection cable: see sheet BDE116/117





ELECTRODES 5.0 MM

MONOPOLAR



		Outer Ø	WL	Product no.
	Coagulation electrode mono Ø 5 mm WL 330 mm	5.0 mm	330 mm	8383.40
	Coagulation electrode mono Ø 5 mm WL 450 mm	5.0 mm	450 mm	8384.40



		Outer Ø	WL	Product no.
	Hook electrode mono Ø 5 mm WL 340 mm	5.0 mm	340 mm	8383.423
	Hook electrode mono Ø 5 mm WL 420 mm		420 mm	8384.423
	Needle electrode mono Ø 5 mm WL 340 mm	5.0 mm	340 mm	8383.426
	Spatula electrode mono Ø 5 mm WL 340 mm	5.0 mm	340 mm	8383.428
	Myoma dissector mono Ø 5 mm WL 340 mm	5.0 mm	340 mm	8383429

HF connection cable: see sheet BDE116/117

MULTIFUNCTIONAL SUCTION IRRIGATION SYSTEM

COMBINATION OPTIONS

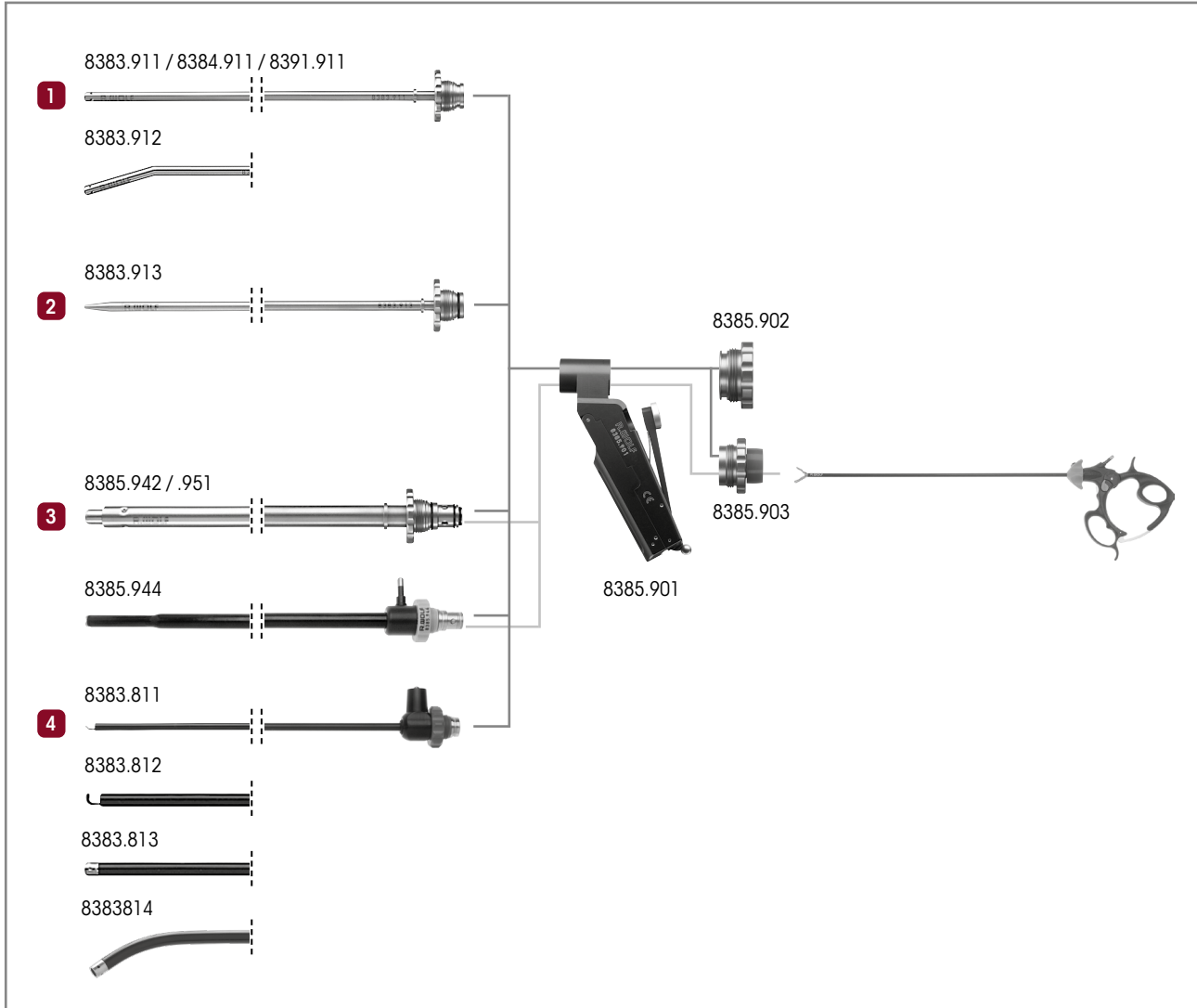

- 1 Suction or irrigation:**
- Suction irrigation tube Ø 5 mm WL 310 mm 8383.911
 - Suction irrigation tube Ø 5 mm WL 450 mm 8384.911
 - Suction irrigation tube Ø 3.5 mm WL 300 mm 8391.911
 - Suction irrigation tube curved Ø 5 mm WL 310 mm... 8383.912
 - for this: **Sealing cap** 8385.902

- 2 Blunt aquadissection:**
- Pressure irrigation tube Ø 5 mm WL 310 mm 8383.913
 - for this: **Sealing cap** 8385.902

- 3 Suction, irrigation, and use of auxiliary instruments Ø 5 mm:**
- Suction irrigation tube Ø 10 mm WL 225 mm 8385.942
 - Suction irrigation tube Ø 10 mm WL 330 mm 8385.951
 - Suction irrigation tube Ø mono 10 mm WL 330 mm, insulated, with atraumatic preparation tip 8385.944
 - for this: **Sealing adapter** 8385.903

- 4 Preparation of tissue with HF:**
- HF suction irrigation tube Ø 5.2 mm WL 317 mm** insulated with integrated HF spatula probe 8383.811
 - HF suction irrigation tube Ø 5.2 mm WL 317 mm** insulated with integrated HF hook electrode 8383.812
 - HF suction irrigation tube Ø 5.2 mm WL 317 mm** insulated with integrated HF button electrode 8383.813
 - HF suction irrigation tube Ø 5.4 mm WL 380 mm** curved with distal openings, insulated with integrated HF button electrode 8383.814
 - for this: **Sealing cap** 8385.902

MULTIFUNCTIONAL SUCTION IRRIGATION SYSTEM

SUCTION IRRIGATION HANDLE

 <p>8385.901</p> <p>AUTOGLAVE 134° C / 273° F</p>	
	Product no.
<p>Suction irrigation handle</p>	8385.901
<p>Sealing cap</p>	8385.902
<p>Required to use auxiliary instruments Ø 5 mm: Sealing attachment with opening and membrane valve</p>	8385.903
<p>Spare Sealing membrane Ø 17 mm yellow, Ø 17 mm, PACK= 10 PCS, for instruments from 3 to 6 mm</p>	89.103

MULTIFUNCTIONAL SUCTION IRRIGATION SYSTEM

SUCTION IRRIGATION TUBE SETS – ILLUSTRATION

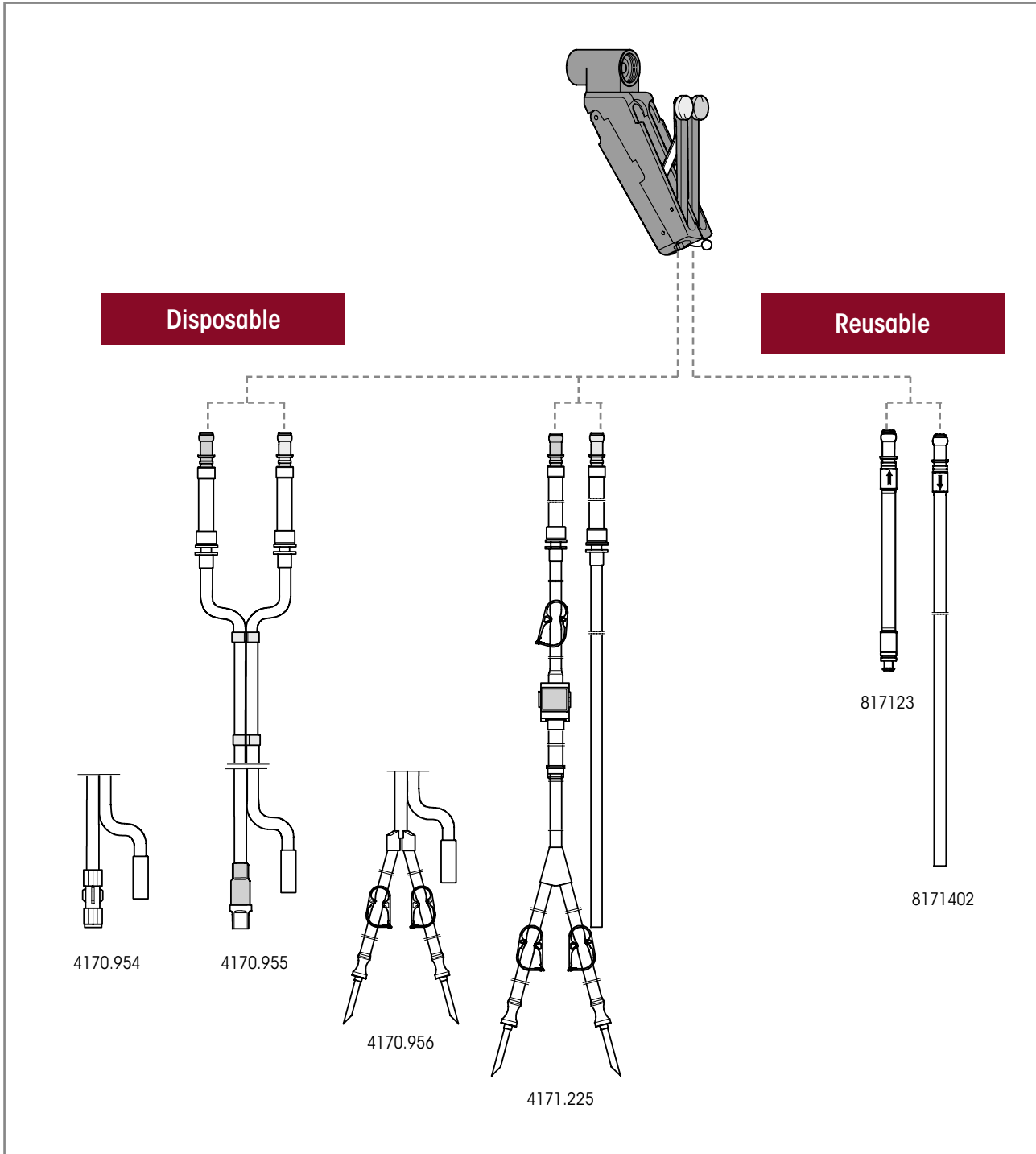

Suction irrigation tube sets are used in conjunction with the suction irrigation handle 8385.901 and pump-side tube systems as well as corresponding collection and secretion containers and/or vacuum pumps.

MULTIFUNCTIONAL SUCTION IRRIGATION SYSTEM







SUCTION IRRIGATION TUBE SETS FOR SUCTION IRRIGATION HANDLE 8385.901

Disposable		Product no.
Suction irrigation tube set, L 3 m (PACK= 10 PCS), sterile	Irrigation tube: With Luer-Lock, for connection to the irrigation tube of a suction irrigation tube set, e.g., irrigation tube of the Endo-Irrigator 2211 Suction tube: For connection to a collection or secretion container and/or vacuum pump	4170.954
Suction irrigation tube set with care-lock, L 3 m (PACK= 10 PCS), sterile	Irrigation tube: With CARE-LOCK, for connection to an irrigation container Suction tube: For connection to a collection or secretion container and/or vacuum pump	4170.955
Suction irrigation tube set with piercing spike, L 3 m (PACK= 10 PCS), sterile	Irrigation tube: With 2 piercing spikes, for connection to an irrigation container Suction tube: For connection to a collection or secretion container and/or vacuum pump	4170.956
Suction irrigation tube set, L 3 m (PACK= 10 PCS), sterile	Irrigation tube: With 2 piercing spikes, for connection to an irrigation container, and Fluid Control Lap 2216 Suction tube: For connection to a collection or secretion container and/or vacuum pump Also observe instruction manual GA-A 276	4171.225
Secretion container, 2.5 l	2.5 liters	41706566
Tube set for suction (2 connections)	sterile disposable product (PACK= 10 PCS), for connecting instruments to collecting container	T0503-01



Reusable		Product no.
Irrigation tube L 1.2 m	Irrigation tube: With Luer-Lockconnection for connection to the irrigation tube of a suction irrigation tube set, e.g., 8171223 or 8170.223	817123
Suction tube L 3 m	silicone, for suction irrigation handle 8385.901	8171402
Secretion container, 2 l	2 liters, without cover	8170.6551
Cover	for secretion trap 8170.6551, reusable	8170.6552



MULTIFUNCTIONAL SUCTION IRRIGATION SYSTEM

SUCTION IRRIGATION TUBES

		Outer Ø	WL	Product no.
				
	Suction irrigation tube Ø 3.5 mm WL 300 mm	3.5 mm	300 mm	8391.911
	Suction irrigation tube Ø 5 mm WL 310 mm	5.0 mm	310 mm	8383.911
	Suction irrigation tube Ø 5 mm WL 450 mm	5.0 mm	450 mm	8384.911
	Suction irrigation tube curved Ø 5 mm WL 310 mm	5.0 mm	310 mm	8383.912
	Pressure irrigation tube Ø 5 mm WL 310 mm	5.0 mm	310 mm	8383.913

Zur Anwendung von 5 mm Hilfsinstrumenten

		Outer Ø	WL	Product no.
				
	Suction irrigation tube Ø 10 mm WL 225 mm	10.0 mm	225 mm	8385.942
Durchlass 5,0 mm	Suction irrigation tube Ø 10 mm WL 330 mm	10.0 mm	330 mm	8385.951





		Outer Ø	WL	Product no.
				
	Saug-Spül-Rohr mono Ø 10 mm NL 330 mm	10,0 mm	330 mm	8385.944
isoliert, mit atraumatischer Präparierspitze				

for use of 5 mm auxiliary instruments		Product no.
	Dichtaufsatz mit Durchgang und Membranventil Dichtmembrane Ø 17 mm	8385.903

MULTIFUNCTIONAL SUCTION IRRIGATION SYSTEM

SUCTION IRRIGATION TUBES



		Outer Ø	WL	Product no.
 insulated with integrated HF spatula probe	HF suction irrigation tube Ø 5.2 mm WL 317 mm	5.2 mm	317 mm	8383.811
 insulated with integrated HF hook probe	HF suction irrigation tube Ø 5.2 mm WL 317 mm	5.2 mm	317 mm	8383.812
 insulated with integrated HF button electrode	HF suction irrigation tube Ø 5.2 mm WL 317 mm	5.2 mm	317 mm	8383.813
as alternative to suction irrigation handle:				
	Suction irrigation adapter with maintenance-free two-way stopcock, for multifunctional suction irrigation system			8583819

Accessories	Product no.
HF connection cable	See page BDE116/117

|| Subject to modifications. Please note that some products may not be available in all countries. Please always take note of the information that is provided with the product. For more detailed information, please consult with your contact partner or directly with Richard Wolf GmbH.

MULTIFUNCTIONAL SUCTION IRRIGATION SYSTEM

SUCTION IRRIGATION TUBES

MULTIFUNCTIONAL SUCTION IRRIGATION SYSTEM



		Outer Ø	WL	Product no.
	Suction tube OD 2.8 mm WL 450 mm	2.8 mm	450 mm	8380.68



		Outer Ø	WL	Product no.
 with Luer connector	Suction irrigation tube Ø 3 mm WL 300 mm	3.0 mm	330 mm	8383.72



		Outer Ø	WL	Product no.
 graduated, with 3 mm Luer connector	Suction tube graduated Ø 5 mm WL 330 mm	5.0 mm	330 mm	8383.68

V124 || Subject to modifications. Please note that some products may not be available in all countries. Please always take note of the information that is provided with the product. For more detailed information, please consult with your contact partner or directly with Richard Wolf GmbH.

ACCESSORIES FOR SUCTION AND IRRIGATION



		Outer Ø	WL	Product no.
with Luer connector and a valve	HF coagulation suction tube mono Ø 5 mm WL 315 mm	5.0 mm	315 mm	8383.71
	HF coagulation suction tube mono Ø 5 mm WL 450 mm	5.0 mm	450 mm	8384.71

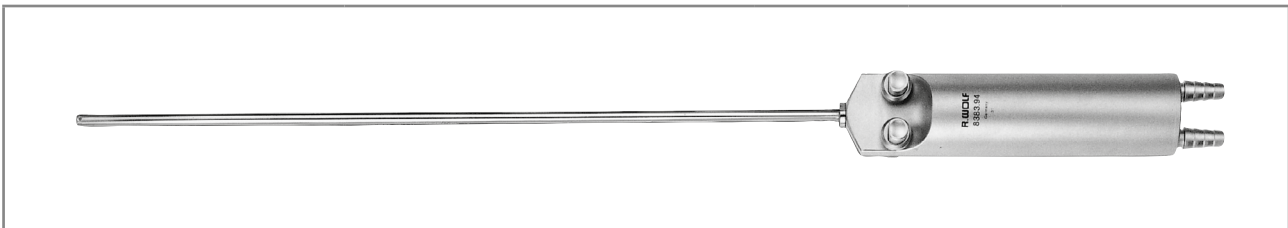

		Outer Ø	WL	Product no.
with stop valve	Suction irrigation tube Ø 5 mm WL 300 mm	5.0 mm	300 mm	8383.94

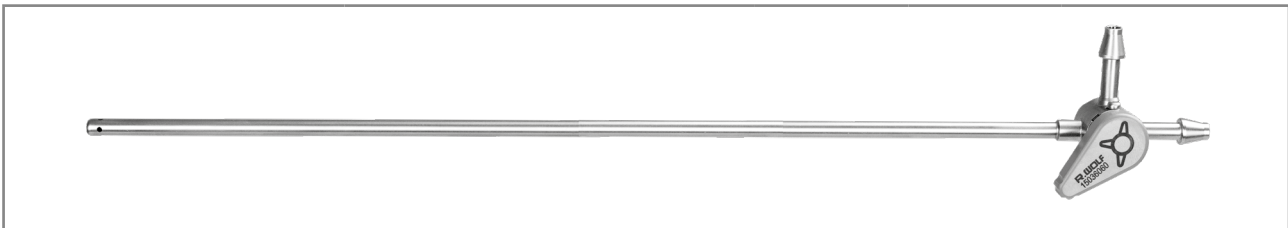

		Outer Ø	WL	Product no.
with maintenance-free two-way stopcock, sheath tube, with distal openings, reusable	Suction irrigation tube WL 290 mm	5.0 mm	290 mm	8583732
	Suction irrigation tube WL 410 mm	5.0 mm	410 mm	8584732

Accessories	Product no.
HF connection cable	See page BDE116/117

V124 || Subject to modifications. Please note that some products may not be available in all countries. Please always take note of the information that is provided with the product. For more detailed information, please consult with your contact partner or directly with Richard Wolf GmbH.

ACCESSORIES

FOR SUCTION AND IRRIGATION

MULTIFUNCTIONAL SUCTION IRRIGATION SYSTEM

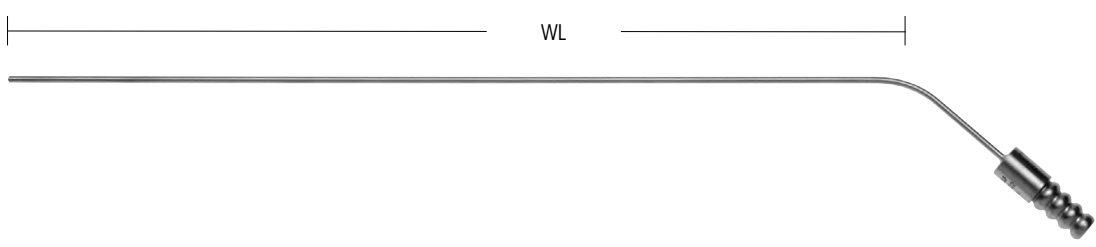

		Outer Ø	WL	Product no.
 central, lateral openings, rigid	Suction tube OD 2 mm WL 250 mm	2.0 mm	250 mm	8291.22
	Suction tube OD 2.5 mm WL 250 mm	2.5 mm	250 mm	8291.23
	Suction tube OD 3 mm WL 250 mm	3.0 mm	250 mm	8291.24
	Suction tube OD 4 mm WL 500 mm	4.0 mm	500 mm	8291.45

V124 || Subject to modifications. Please note that some products may not be available in all countries. Please always take note of the information that is provided with the product. For more detailed information, please consult with your contact partner or directly with Richard Wolf GmbH.

DISPOSABLE HAND BLOWER FOR SUCTION AND IRRIGATION

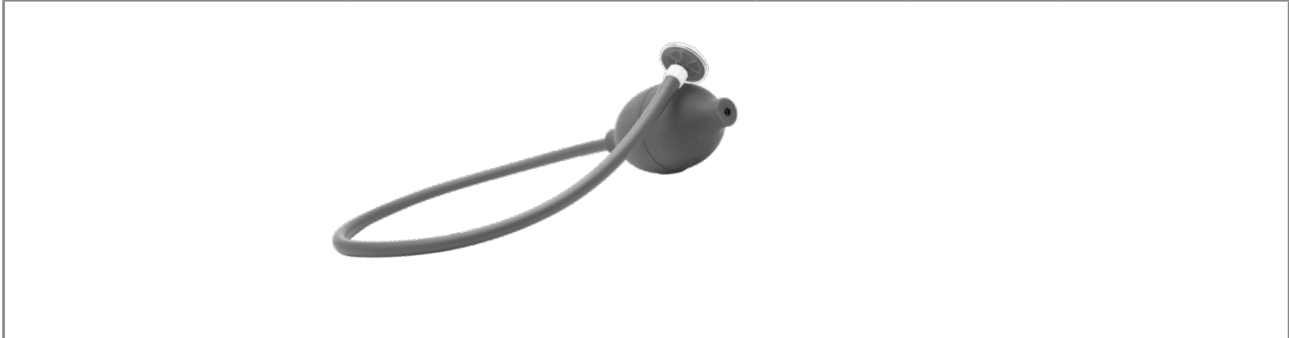

for air insufflation		Ø	TL	Product no.
	<p>Hand blower with disposable filter, sterile (PACK= 5 PCS)</p>	49 mm	567 mm	412700

TISSUE RETRACTOR 5 MM

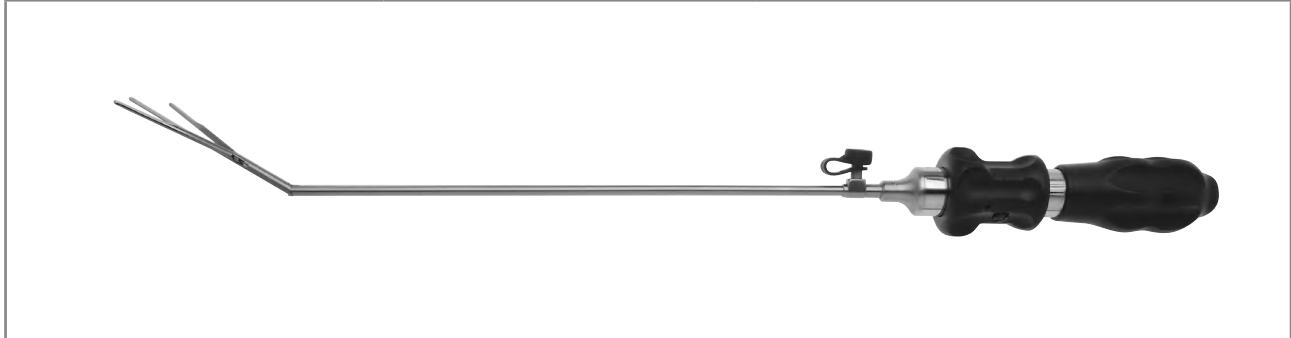



		Outer Ø	WL	Product no.
	tissue retractor Ø 5 mm WL 320 mm	5.0 mm	320 mm	8383.691

Accessories	Product no.
Luer sealing cap	887.00

VI24 || Subject to modifications. Please note that some products may not be available in all countries. Please always take note of the information that is provided with the product. For more detailed information, please consult with your contact partner or directly with Richard Wolf GmbH.

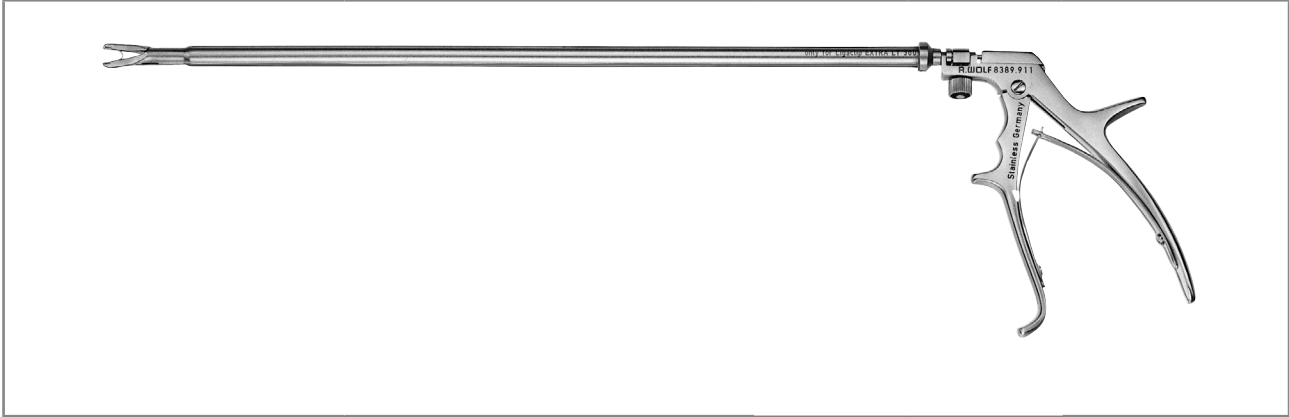
CLIP APPLICATOR 10 MM FOR SUCTION AND IRRIGATION



		Outer Ø	WL	Product no.
	Clip applicator Ø 10 mm WL 340 mm	10 mm	340 mm	8389.911
for this:				Product no.
	Introduction sleeve 10 mm WL 80 mm with sealing cap			8389.991
For clip ligation with Ethicon® Ligaclip® EXTRA LT 300				
Ethicon® Ligaclips® (PACK= 108 PCS)				8389.915

Accessories	Product no.
Sealing cap capacity 9.5–10.1 mm	89.08

CLIP APPLICATOR

10

V124 || Subject to modifications. Please note that some products may not be available in all countries. Please always take note of the information that is provided with the product. For more detailed information, please consult with your contact partner or directly with Richard Wolf GmbH.

ERAGON^{stitch}



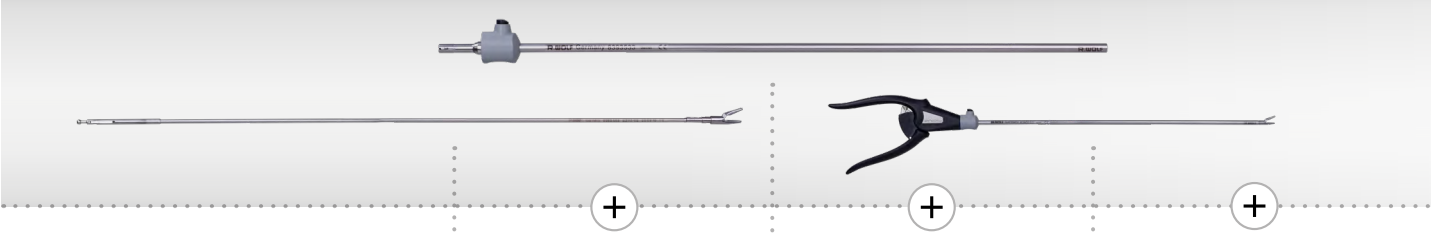

THE ERGONOMIC GENERATION OF NEEDLE HOLDERS

Thanks to the custom combination options it offers, **ERAGON^{stitch}** can accommodate any user requirement. The way in which it brings together ergonomics, versatility, modularity, and precision sets new standards in comfort

ERAGONSTITCH NEEDLE HOLDER

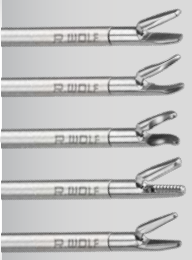
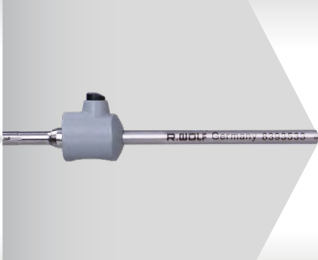

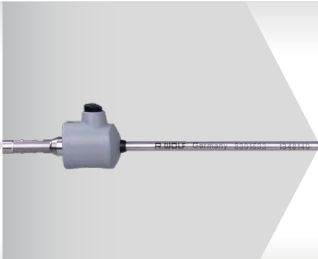
+ + +





	Choose working length	Choose jaw insert	Choose sheath tube	Choose handle
<p>∅</p> <p>5.0 mm</p>	<p>330 mm</p> <p>450 mm</p>			
<p>∅</p> <p>3.5 mm</p>	<p>240 mm</p> <p>330 mm</p>			

ERAGONstitch needle holders



ERAGON*stitch*
NEEDLE HOLDER Ø 3.5 MM



Needle holder jaw insert			Sheath tube, Ø 3.5 mm		Needle holder handle		Complete instrument • Jaw insert • Sheath tube • Handle	
								Product no.
	JL*	Product no.	8390533	8391533	8393943	8393944	Product no.	
	12 mm	8391505	•		•		83915053	
			•		•		83915054	
straight with carbide insert single-action		8391506		•	•		83915063	
				•		•	83915064	







* JL = jaw length when jaw section closed (approximate measurements)

Accessories for manual and machine reprocessing	Product no.
 Irrigation adapter cleaning Ø 9 mm, length 64 mm for uninsulated sheath tubes	163503

V124 || Subject to modifications. Please note that some products may not be available in all countries. Please always take note of the information that is provided with the product. For more detailed information, please consult with your contact partner or directly with Richard Wolf GmbH.

ERAGON^{stitch}





NEEDLE HOLDER Ø 5.0 MM

Needle holder jaw insert			Sheath tube, Ø 5.0 mm		Needle holder handle		Complete instrument • Jaw insert • Sheath tube • Handle
							
	JL*	Product no.	8393533	8394533	axial	angled	Product no.
	19 mm	Needle holder Ø 5 mm bndl	•		•		83935073
			•			•	83935074
straight with carbide insert single-action	19 mm	8393507		•	•		83945073
		8394507		•		•	83945074
	19 mm	Needle holder Ø 5 mm bndl	•		•		83935083
			•			•	83935084
straight and narrow with carbide insert single-action	19 mm	8393508		•	•		83945083
		8394508		•		•	83945084
	19 mm	Needle holder jaw insert Ø 5 mm bndl	•		•		83935093
			•			•	83935094
straight, with self-righting function single-action	19 mm	8393509		•	•		83945093
		8394509		•		•	83945094

* JL = jaw length when jaw section closed (approximate measurements)

Accessories for manual and machine reprocessing		Product no.
	Irrigation adapter cleaning Ø 9 mm, length 64 mm for uninsulated sheath tubes	163503

ERAGON *stitch*
NEEDLE HOLDER Ø 5.0 MM

Needle holder jaw insert			Sheath tube, Ø 5.0 mm		Needle holder handle		Complete instrument • Jaw insert • Sheath tube • Handle
							
	JL*	Product no.	8393533	8394533	Axial 8393943	Angled 8393944	Product no.
	19 mm	Needle holder Ø 5 mm bndl	•		•		83935183
		curved right with carbide insert single-action	•			•	83935184
		8394518		•	•		83945183
				•		•	83945184
	19 mm	Needle holder Ø 5 mm bndl	•		•		83935193
		Curved left with carbide insert single-action	•			•	83935194
		8394519		•	•		83945193
			•			•	83945194

Accessories for manual and machine reprocessing	Product no.
 Irrigation adapter cleaning Ø 9 mm, length 64 mm for uninsulated sheath tubes	163503













V124 || Subject to modifications. Please note that some products may not be available in all countries. Please always take note of the information that is provided with the product. For more detailed information, please consult with your contact partner or directly with Richard Wolf GmbH.

ERAGONSTITCH NEEDLE HOLDER

11

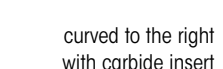
NEEDLE HOLDER Ø 3.5 MM/5 MM

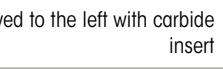
MODULAR SYSTEM

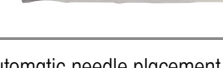

					
Needle holder jaw insert with sheath				Needle holder handle, axial	
					
				single-action locking mechanism, can be disabled	
	Product no.	Ø	SL	8393.941	Product no.
Needle holder Ø 3.5 mm bndl					
 with carbide insert					
Needle holder Ø 5 mm bndl					
 for straight needles					
Needle holder Ø 5 mm bndl					
 with carbide insert					
 with carbide insert	8394505	5 mm	430 mm	•	8394.502
Needle holder Ø 5 mm bndl					
 curved to the right with carbide insert					
 curved to the right with carbide insert	8394514	5 mm	430 mm	•	8394.511
Needle holder Ø 5 mm bndl					
 curved to the left with carbide insert					
 curved to the left with carbide insert	8394515	5 mm	430 mm	•	8394.512
Sarbu needle holder Ø 5 mm bndl					
					
	8394506	5 mm	430 mm	•	8394.503*

* with automatic needle placement apparatus and cutting edge

V124 || Subject to modifications. Please note that some products may not be available in all countries. Please always take note of the information that is provided with the product. For more detailed information, please consult with your contact partner or directly with Richard Wolf GmbH.

NEEDLE HOLDER HANDLE







Needle holder handle, axial	not rotatable	with lock	without HF	Product no.
	•	•	•	8393.941



Needle holder handle <small>ERAGON</small> <small>stitch</small>	axial	angled	with on-off detent mechanism	single-action	Not rotatable	Product no.
	•		•	•	•	8393943
		•	•	•	•	8393944

V124 || Subject to modifications. Please note that some products may not be available in all countries. Please always take note of the information that is provided with the product. For more detailed information, please consult with your contact partner or directly with Richard Wolf GmbH.

ERAGON modular

MODULAR KNOT PUSHER Ø 5.0 MM, INSULATED

		Handle, axial			
 All jaw inserts and sheath tubes can also be combined with ERAGONaxial					
		with lock	without lock, with HF connector	without lock, with HF connector	with lock, not rotatable
Rotatable knob	Product no.	83930082	83930083	83930084	83930085
	8988	•	•	•	•

Jaw insert		Sheath tube, Ø 5.0 mm, insulated		Handle	Complete instrument • Jaw insert with sheath tube • Handle	
  JL		SL 330 mm	SL 450 mm	 with lock, without HF		
	JL*	Product no.	8393933	8394933	83930072	Product no.
Knot pusher Ø 5 mm bndl	17 mm	8393.345	•		•	83933457
with distal recess, double-action		8394345		•	•	83943457

KNOT PUSHER

11



* JL = jaw length when jaw section closed (approximate measurements)

HF connection cable: see sheet BDE116/117

V124 || Subject to modifications. Please note that some products may not be available in all countries. Please always take note of the information that is provided with the product. For more detailed information, please consult with your contact partner or directly with Richard Wolf GmbH.

KNOT PUSHER 5 MM FOR ENDOSCOPIC SUTURING



		Outer Ø	WL	TL	Product no.
	Knot pusher Ø 3.7 mm WL 330 mm for intraabdominal knots	3.7 mm	330 mm	380 mm	8383.55
	Knot pusher Ø 3.7 mm WL 330 mm for extracorporeal knots	3.7 mm	330 mm	380 mm	8383.551





		Outer Ø	WL	TL	Product no.
	Knot pusher Ø 5 mm WL 330 mm as per Bueß with distal notch and lateral opening for optimum knotting, extremely atraumatic tip for use as a surgical probe	5.0 mm	330 mm	380 mm	8383.552

V124 || Subject to modifications. Please note that some products may not be available in all countries. Please always take note of the information that is provided with the product. For more detailed information, please consult with your contact partner or directly with Richard Wolf GmbH.



Endoscopically controlled fascia closure system



AS PER BUSCHE



				Product no.
 <p>for subcutaneous fascia suture</p>	Sealing cone Ø 10–12 mm			8934.915
	Sealing cone Ø 12–15 mm			8943.915
	Sealing cone Ø 15–20 mm			8945.915
		Ø	WL	Product no.
 <p>Needle forceps with active suture holder</p>	Needle forceps Ø 2.45 mm WL 160 mm	2.45 mm	160 mm	8756.201

CANNULAS 3.0 MM/4.7 MM

				
with Luer connector		Outer Ø	WL	Product no.
 Tip Ø 1.4 mm	Injection cannula Ø 3 mm WL 340 mm	3.0 mm	340 mm	8379.732

				
with 3 mm Luer connector		Ø	WL	Product no.
 Tip Ø 1.8 mm	Injection cannula Ø 4.7 mm WL 350 mm	4.7 mm	350 mm	8383.65

for this:		WL	Product no.
	<p>Introduction sleeve size 5.5 mm WL 45 mm</p> <p>This sleeve prevents damage to the cannula tip when the trocar sleeve valve is opened</p>	45 mm	8383.00

V124 || Subject to modifications. Please note that some products may not be available in all countries. Please always take note of the information that is provided with the product. For more detailed information, please consult with your contact partner or directly with Richard Wolf GmbH.

SURGICAL PROBES



		Ø	WL	Product no.
	Surgical probe 3.5 mm WL 350 mm graduated	3.5 mm	350 mm	8379.672



		Ø	WL	Product no.
	Surgical probe Ø 5 mm WL 328 mm graduated	5.0 mm	328 mm	8383.66
	Surgical probe Ø 5 mm WL 448 mm graduated	5.0 mm	448 mm	8384.66

V124 || Subject to modifications. Please note that some products may not be available in all countries. Please always take note of the information that is provided with the product. For more detailed information, please consult with your contact partner or directly with Richard Wolf GmbH.

MYOMA DRILL 5 MM/10 MM



		Ø	WL	Product no.
	Myoma drill Ø 5 mm WL 320 mm	5 mm	320 mm	8383.611
	Myoma drill Ø 10 mm	10 mm	340 mm	8385.301

V124 || Subject to modifications. Please note that some products may not be available in all countries. Please always take note of the information that is provided with the product. For more detailed information, please consult with your contact partner or directly with Richard Wolf GmbH.

INSUFFLATOR HIGHFLOW 45 BASIC



		Product no.
Insufflator 45 BASIC bndl consisting of: Insufflator 45 BASIC FR 45 l/min (2235001) and power cable 3 m long (2440.03)		22350012
Accessories: Tube sets for insufflation		
Insufflation set , insufflation tube with integrated hygiene filter, disposable, (PACK= 10 PCS) in individual sterile packaging		2200/48BIKBTUA123
Insufflation tube set L 2.5 m , High Flow, D = 8 mm, autoclavable		8170.232
Insufflation tube set L 2.5 m , autoclavable		8170.101
Hygiene filter , sterile, disposable (PACK= 10 PCS) in individual sterile packaging		4171.111
Accessories for gas supply CO₂ bottle		
Qualityreg CO₂ , Inlet pressure connection DIN ISO 477-6 outlet connection NIST, pressure gauge Flow meter	DIN ISO 477-6	DM-DIN6-MS-NISTCO2
Qualityreg CO₂ , Inlet connection DIN EN ISO 407 PIN INDEX, outlet connection NIST ,pressure gauge Flow meter	DIN EN ISO 407 PIN INDEX	DM-PIN-MS-NIST-CO2
Qualityreg CO₂ , Inlet connection ISO 5145 outlet connection NIST, pressure gauge Flow meter	ISO 5145	DM-ISO-MS-NIST-CO2
with		
Connection hose, quality CONNECT , CO ₂ 1.5 m long		DINCO2NIST-NIST1.5
Optional for faster CO₂ bottle changes		
Quick plug adapter NIST , (2 pieces recommended) DIN with safety chain, adapter NIST / coupling with chain and ring		DM-AD-CO2NISTDINKU
Connection hose DIN, CO₂ , ZGV plug to NIST fitting, ISO-colored, 1.5 m long (Ceiling light)		DIN-CO2-ZGVNIST1.5
ZGV connection		
Connection hose, quality CONNECT , CO ₂ 5 m long, DIN for centralized CO ₂ gas supply (Dräger)		RW-CO2-ZGV-NIST5.0
Connection hose, quality CONNECT , CO ₂ 5 m long, NF for centralized CO ₂ gas supply (Liquid Air)		NF-CO2-ZGV-NIST5.0
Connection hose DIN, CO₂ , ZGV plug to NIST fitting, ISO-colored, 1.5 m long (Ceiling light)		DIN-CO2-ZGVNIST1.5
Software modules (optional)		
Software module CAN bus CAN bus interface for integration in CORE		2235101
Software module BABY MODE BABY MODE for special use in pediatrics		2235102
Software module VIDEO DISPLAY : video display using DIALOG via CAN bus		2235103

TECHNICAL DATA

INSUFFLATOR HIGHFLOW 45 BASIC

Insufflator 45 BASIC		2235001
Device properties		
Operating mode	Continuous operation	
Operating conditions	+10°C to +40°C, 30% to 75% rel. humidity, atmospheric pressure 700 hPa to 1,060 hPa	
Storage and transport conditions	-20°C to +60°C, 10% to 90% rel. humidity, atmospheric pressure 700 hPa to 1,060 hPa	
Power supply		
Mains + frequency	100–240 V~, 50/60 Hz	
Power consumption	60 VA	
Current rating	0.6–0.2 A	
Fuse	T 3.15 AH 250 V	
Regulatory standards		
Protection class to IEC/EN 60601-1 (UL 60601-1/CSA C222 No6011 – for USA)	I	
Electromagnetic compatibility (EMC)	IEC/EN 60601-1-2	
Medical Devices Directive 93/42/EEC	Class IIb	
Protection against electric shock	Type CF applied part	
Degree of protection against the ingress of liquids	IP 20 (not protected)	
Degree of protection in the presence of flammable mixtures	Device is not protected against explosions (do not operate this device in explosive atmospheres)	
Dimensions and weights		
Weight	8.9 kg (19.5 lbs)	
Dimensions (W x H x D)	300 mm x 160 mm x 455 mm	

Relevant application parameters	
Insufflation medium	Medical-grade CO ₂ (degree of purity > 99.5%)
Intraabdominal pressure	3 mmHg to 25 mmHg (± 2 mmHg) selectable in increments of 1 mmHg
Gas flow rate primary filling	1 l/min (± 50%)
Gas flow rate, High Flow	2 l/min to 45 l/min (± 20%) selectable in increments of 1 l/min
Consumption indicator	0 l to 9,999 l (± 20%)

INSUFFLATOR HIGHFLOW 45 EVAC + HEAT

WITH SMOKE GAS EVACUATION AND GAS HEATING



		Artikel-Nr.
Insufflator 45 EVAC + HEAT bndI		22350312
consisting of: Insufflator 45 EVAC + HEAT FR 45 l/min(2235031), power cable, 3 m long (2440.03) and footswitch with 1 pedal (20301031)		
Accessories: Tube sets for insufflation with heating and smoke gas evacuation		
Insufflation tube set L 3m high-flow with heating coil and integrated hygiene filter, (PACK=10 PCS), sterile, for single use		4170502
Insufflation tube for 2235021/031 L 3m , high-flow with heating coil, autoclavable Up to 100 uses are possible with the reusable hose.		8170202
Hygiene filter , sterile, disposable (PACK= 10 PCS) in individual sterile packaging		4171.111
Smoke gas evacuation tube set , steril, sterile, for single use (PACK= 10 PCS)		2200/72BTUA1230001
Accessories for gas supply CO₂ bottle		
Qualityreg CO₂ , Inlet pressure connection DIN ISO 477-6 outlet connection NIST, pressure gauge Flow meter	DIN ISO 477-6	DM-DIN6-MS-NISTCO2
Qualityreg CO₂ , Inlet connection DIN EN ISO 407 PIN INDEX, outlet connection NIST ,pressure gauge Flow meter	DIN EN ISO 407 PIN INDEX	DM-PIN-MS-NIST-CO2
Qualityreg CO₂ , Inlet connection ISO 5145 outlet connection NIST, pressure gauge Flow meter	ISO 5145	DM-ISO-MS-NIST-CO2
with		
Connection hose, quality CONNECT , CO ₂ 1.5 m long		DINCO2NIST-NIST1.5
Optional for faster CO₂ bottle changes		
Quick plug adapter NIST , (2 pieces recommended) DIN with safety chain, adapter NIST / coupling with chain and ring		DM-AD-CO2NISTDINKU
Connection hose DIN, CO₂ , ZGV plug to NIST fitting, ISO-colored, 1.5 m long (Ceiling light)		DIN-CO2-ZGVNIST1.5
ZGV connection		
Connection hose, quality CONNECT , CO ₂ 5 m long, DIN for centralized CO ₂ gas supply (Dräger)		RW-CO2-ZGV-NIST5.0
Connection hose, quality CONNECT , CO ₂ 5 m long, NF for centralized CO ₂ gas supply (Liquid Air)		NF-CO2-ZGV-NIST5.0
Connection hose DIN, CO₂ , ZGV plug to NIST fitting, ISO-colored, 1.5 m long (Ceiling light)		DIN-CO2-ZGVNIST1.5
Software modules (optional)		
Software module CAN bus CAN bus interface for integration in CORE		2235101
Software module BABY MODE BABY MODE for special use in pediatrics		2235102
Software module VIDEO DISPLAY: video display using DIALOG via CAN bus		2235103

TECHNICAL DATA

INSUFFLATOR HIGHFLOW 45 EVAC

Insufflator 45 EVAC		2235011
Device properties		
Operating mode	Continuous operation	
Operating conditions	+10°C to +40°C, 30% to 75% rel. humidity, atmospheric pressure 700 hPa to 1,060 hPa	
Storage and transport conditions	-20°C to +60°C, 10% to 90% rel. humidity, atmospheric pressure 700 hPa to 1,060 hPa	
Power supply		
Mains + frequency	100–240 V~, 50/60 Hz	
Power consumption	60 VA	
Current rating	0.6–0.2 A	
Fuse	T 3.15 AH 250 V	
Regulatory standards		
Protection class to IEC/EN 60601-1 (UL 60601-1/CSA C222 No6011 – for USA)	I	
Electromagnetic compatibility (EMC)	IEC/EN 60601-1-2	
Medical Devices Directive 93/42/EEC	Class IIb	
Protection against electric shock	Type CF applied part	
Degree of protection against the ingress of liquids	IP 20 (not protected)	
Degree of protection in the presence of flammable mixtures	Device is not protected against explosions (do not operate this device in explosive atmospheres)	
Dimensions and weights		
Weight	8.9 kg (19.5 lbs)	
Dimensions (W x H x D)	300 mm x 160 mm x 455 mm	

Relevant application parameters	
Insufflation medium	Medical-grade CO ₂ (degree of purity > 99.5%)
Intraabdominal pressure	3 mmHg to 25 mmHg (± 2 mmHg) selectable in increments of 1 mmHg
Gas flow rate primary filling	1 l/min (± 50%)
Gas flow rate, High Flow	2 l/min to 45 l/min (± 20%) selectable in increments of 1 l/min
Consumption indicator	0 l to 9,999 l (± 20%)

INSUFFLATOR HIGHFLOW 45 HEAT WITH GAS HEATING



		Product no.
Insufflator 45 HEAT bndl consisting of: Insufflator 45 HEAT FR 45 L/min(2235021) and power cable, 3 m long (2440.03)		22350212
Accessories: Tube sets for insufflation with heating		
Insufflation tube set L 3m high-flow with heating coil and integrated hygiene filter, (PACK=10 PCS), sterile, for single use		4170502
Insufflation tube for 2235021/031 L 3m , high-flow with heating coil, autoclavable Up to 100 uses are possible with the reusable hose.		8170202
Hygiene filter , sterile, disposable (PACK= 10 PCS) in individual sterile packaging		4171.111
Accessories for gas supply CO₂ bottle		
Qualityreg CO₂ , Inlet pressure connection DIN ISO 477-6 outlet connection NIST, pressure gauge Flow meter	DIN ISO 477-6	DM-DIN6-MS-NISTCO2
Qualityreg CO₂ , Inlet connection DIN EN ISO 407 PIN INDEX, outlet connection NIST ,pressure gauge Flow meter	DIN EN ISO 407 PIN INDEX	DM-PIN-MS-NIST-CO2
Qualityreg CO₂ , Inlet connection ISO 5145 outlet connection NIST, pressure gauge Flow meter	ISO 5145	DM-ISO-MS-NIST-CO2
with		
Connection hose, quality CONNECT , CO ₂ 1.5 m long		DINCO2NIST-NIST1.5
Optional for faster CO₂ bottle changes		
Quick plug adapter NIST , (2 pieces recommended) DIN with safety chain, adapter NIST / coupling with chain and ring		DM-AD-CO2NISTDINKU
Connection hose DIN, CO₂ , ZGV plug to NIST fitting, ISO-colored, 1.5 m long (Ceiling light)		DIN-CO2-ZGVNIST1.5
ZGV connection		
Connection hose, quality CONNECT , CO ₂ 5 m long, DIN for centralized CO ₂ gas supply (Dräger)		RW-CO2-ZGV-NIST5.0
Connection hose, quality CONNECT , CO ₂ 5 m long, NF for centralized CO ₂ gas supply (Liquid Air)		NF-CO2-ZGV-NIST5.0
Connection hose DIN, CO₂ , ZGV plug to NIST fitting, ISO-colored, 1.5 m long (Ceiling light)		DIN-CO2-ZGVNIST1.5
Software modules (optional)		
Software module CAN bus CAN bus interface for integration in CORE		2235101
Software module BABY MODE BABY MODE for special use in pediatrics		2235102
Software module VIDEO DISPLAY : video display using DIALOG via CAN bus		2235103

TECHNICAL DATA

INSUFFLATOR HIGHFLOW 45 HEAT

Insufflator 45 HEAT		2235021
Device properties		
Operating mode	Continuous operation	
Operating conditions	+10°C to +40°C, 30% to 75% rel. humidity, atmospheric pressure 700 hPa to 1,060 hPa	
Storage and transport conditions	-20°C to +60°C, 10% to 90% rel. humidity, atmospheric pressure 700 hPa to 1,060 hPa	
Power supply		
Mains + frequency	100–127/220–240 V~, 50/60 Hz	
Power consumption	80 VA	
Current rating	0.8–0.3 A	
Fuse	T 3.15 AH 250 V	
Regulatory standards		
Protection class to IEC/EN 60601-1 (UL 60601-1/CSA C222 No6011 – for USA)	I	
Electromagnetic compatibility (EMC)	IEC/EN 60601-1-2	
Medical Devices Directive 93/42/EEC	Class IIb	
Protection against electric shock	Type CF applied part	
Degree of protection against the ingress of liquids	IP 20 (not protected)	
Degree of protection in the presence of flammable mixtures	Device is not protected against explosions (do not operate this device in explosive atmospheres)	
Dimensions and weights		
Weight	11.0 kg (23.3 lbs)	
Dimensions (W x H x D)	300 mm x 160 mm x 455 mm	
Relevant application parameters		
Insufflation medium	Medical-grade CO ₂ (degree of purity > 99.5%)	
Intraabdominal pressure	3 mmHg to 25 mmHg (± 2 mmHg) selectable in increments of 1 mmHg	
Gas flow rate primary filling	1 l/min (± 50%)	
Gas flow rate, High Flow	2 l/min to 45 l/min (± 20%) selectable in increments of 1 l/min	
Consumption indicator	0 l to 9,999 l (± 20%)	

INSUFFLATOR HIGHFLOW 45 EVAC + HEAT

WITH SMOKE GAS EVACUATION AND GAS HEATING



		Artikel-Nr.
Insufflator 45 EVAC + HEAT bndI		22350312
consisting of: Insufflator 45 EVAC + HEAT FR 45 l/min(2235031), power cable, 3 m long (2440.03) and footswitch with 1 pedal (20301031)		
Accessories: Tube sets for insufflation with heating and smoke gas evacuation		
Insufflation tube set L 3m high-flow with heating coil and integrated hygiene filter, (PACK=10 PCS), sterile, for single use		4170502
Insufflation tube for 2235021/031 L 3m , high-flow with heating coil, autoclavable Up to 100 uses are possible with the reusable hose.		8170202
Hygiene filter , sterile, disposable (PACK= 10 PCS) in individual sterile packaging		4171.111
Smoke gas evacuation tube set , steril, sterile, for single use (PACK= 10 PCS)		2200/72BTUA1230001
Accessories for gas supply CO₂ bottle		
Qualityreg CO₂ , Inlet pressure connection DIN ISO 477-6 outlet connection NIST, pressure gauge Flow meter	DIN ISO 477-6	DM-DIN6-MS-NISTCO2
Qualityreg CO₂ , Inlet connection DIN EN ISO 407 PIN INDEX, outlet connection NIST ,pressure gauge Flow meter	DIN EN ISO 407 PIN INDEX	DM-PIN-MS-NIST-CO2
Qualityreg CO₂ , Inlet connection ISO 5145 outlet connection NIST, pressure gauge Flow meter	ISO 5145	DM-ISO-MS-NIST-CO2
with		
Connection hose, quality CONNECT , CO ₂ 1.5 m long		DINCO2NIST-NIST1.5
Optional for faster CO₂ bottle changes		
Quick plug adapter NIST , (2 pieces recommended) DIN with safety chain, adapter NIST / coupling with chain and ring		DM-AD-CO2NISTDINKU
Connection hose DIN, CO₂ , ZGV plug to NIST fitting, ISO-colored, 1.5 m long (Ceiling light)		DIN-CO2-ZGVNIST1.5
ZGV connection		
Connection hose, quality CONNECT , CO ₂ 5 m long, DIN for centralized CO ₂ gas supply (Dräger)		RW-CO2-ZGV-NIST5.0
Connection hose, quality CONNECT , CO ₂ 5 m long, NF for centralized CO ₂ gas supply (Liquid Air)		NF-CO2-ZGV-NIST5.0
Connection hose DIN, CO₂ , ZGV plug to NIST fitting, ISO-colored, 1.5 m long (Ceiling light)		DIN-CO2-ZGVNIST1.5
Software modules (optional)		
Software module CAN bus CAN bus interface for integration in CORE		2235101
Software module BABY MODE BABY MODE for special use in pediatrics		2235102
Software module VIDEO DISPLAY: video display using DIALOG via CAN bus		2235103

TECHNICAL DATA



INSUFFLATOR HIGHFLOW 45 EVAC + HEAT

Insufflator 45 EVAC + HEAT		2235031
Device properties		
Operating mode	Continuous operation	
Operating conditions	+10°C to +40°C, 30% to 75% rel. humidity, atmospheric pressure 700 hPa to 1,060 hPa	
Storage and transport conditions	-20°C to +60°C, 10% to 90% rel. humidity, atmospheric pressure 700 hPa to 1,060 hPa	
Power supply		
Mains + frequency	100–127/220–240 V~, 50/60 Hz	
Power consumption	80 VA	
Current rating	0.8–0.3 A	
Fuse	T 3.15 AH 250 V	
Regulatory standards		
Protection class to IEC/EN 60601-1 (UL 60601-1/CSA C222 No6011 – for USA)	I	
Electromagnetic compatibility (EMC)	IEC/EN 60601-1-2	
Medical Devices Directive 93/42/EEC	Class IIb	
Protection against electric shock	Type CF applied part	
Degree of protection against the ingress of liquids	IP 20 (not protected)	
Degree of protection in the presence of flammable mixtures	Device is not protected against explosions (do not operate this device in explosive atmospheres)	
Dimensions and weights		
Weight	11.0 kg (23.3 lbs)	
Dimensions (W x H x D)	300 x 160 x 455 mm	

Relevant application parameters	
Insufflation medium	Medical-grade CO ₂ (degree of purity > 99.5%)
Intraabdominal pressure	3 mmHg to 25 mmHg (± 2 mmHg) selectable in increments of 1 mmHg
Gas flow rate primary filling	1 l/min (± 50%)
Gas flow rate, High Flow	2 l/min to 45 l/min (± 20%) selectable in increments of 1 l/min
Consumption indicator	0 l to 9,999 l (± 20%)

STERILE SMOKE

FOR SMOKE GAS DISCHARGE

 	
Product no.	
<p>Smoke set smoke filter with tube (PACK= 10 PCS) in individual sterile packaging</p>	<p>2200/47BDKBTUA123</p>

V124 || Subject to modifications. Please note that some products may not be available in all countries. Please always take note of the information that is provided with the product. For more detailed information, please consult with your contact partner or directly with Richard Wolf GmbH.

FLUID CONTROL 2225

SUCTION IRRIGATION PUMP



core

		Product no.
FLUID CONTROL 2225 Irrigation pump for Hys/Uro/Lap bndl consisting of: Irrigation pump for Hys/Uro/Lap (2225001) and power cable 3 m long (2440.03)		22250011
for this:		
Balancing module for hysteroscopy and endourology, fluid management for fluid balancing in combination with FLUID CONTROL 2225, mobile stand with integrated weighing cells and space for up to 4 irrigation fluid bags		2225023

Accessories		Product no.
Footswitch	only for use in urology and within the indication TUR/enucleation, possibility of short-term increase in pressure if visibility is poor (Flush function)	2204901

V124 || Subject to modifications. Please note that some products may not be available in all countries. Please always take note of the information that is provided with the product. For more detailed information, please consult with your contact partner or directly with Richard Wolf GmbH.

FLUID CONTROL 2225

SUCTION IRRIGATION TUBE SETS

Irrigation			Product no.
Accessories – reusable	Tube set with piercing spike	with Luer-Lock connection, autoclavable, incl. 10 spare membranes, reusable for 20 reprocessing cycles	8171223
Accessories – disposable	Irrigation tube set with piercing spike, L 3 m	(PACK= 10 PCS), with Luer-Lock connection, sterile, disposable product	4171223
	Tube set with CARE-LOCK, L 3 m	(PACK= 10 PCS), sterile, disposable product	4171224
	Suction irrigation tube set	(PACK= 10 PCS), with piercing spike, sterile disposable product, PVC	4171225

Suction			Product no.
Accessories – reusable	Tube set for vacuum, incl. filter	with integrated hygiene filter, PACK= 10 PCS, service life: 30 days (connected to irrigation pump)	2206207
	Irrigation tube	L 1.2 m, with Luer-Lock, for suction irrigation handle 8385.901 and tube set 8171223 or 8170.223	817123
	Suction tube L 3 m	for suction irrigation handle 8385.901	8171402
	Secretion container, 2 l	2 liters, without cover	8170.6551
	Cover	for secretion trap 8170.6551, reusable	8170.6552
Accessories – disposable	Secretion container, 2.5 l	2.5 liters	41706566
	Secretion container bndl consisting of:	Secretion container 2.5 l (41706566) and secretion bag (PACK= 90 PCS) (41706564)	4170657
	Tube set for suction (2 connections)	sterile, disposable product, (PACK= 10 PCS) for connecting instruments to collecting container	T0503-01
	Angled 90° plug-in coupling	(PACK= 10 PCS) For connecting vacuum tube 2206207 to disposable container systems	0771019

FLUID CONTROL 2225

CABLE ACCESSORIES

		Product no.
Patch cable, RJ45 SFTP, 0.5 m	Cable length 0.5 m	72325378
Patch cable, RJ45 HRS TM11, 1.0 m	Cable length 1.0 m	72325429
Patch cable, RJ45 S/FTP CAT6 10 m	Cable length 10 m	72325434
Plastic caps for network socket	(PACK= 8 PCS)	5592105
Power cable	Cable length 3 m	2440.03

VI24 || Subject to modifications. Please note that some products may not be available in all countries. Please always take note of the information that is provided with the product. For more detailed information, please consult with your contact partner or directly with Richard Wolf GmbH.

TECHNICAL DATA

FLUID CONTROL 2225

FLUID CONTROL 2225		2225001
Device properties		
Operating conditions		+10°C to +40°C, 30% to 75% rel. humidity, 70 to 106 kPa atmospheric pressure 3,000 m max. altitude above sea level
Storage and transport conditions		-20°C to +60°C, 10% to 90% rel. humidity 70 to 106 kPa atmospheric pressure
Power supply		
Mains + frequency		100–240 V~, 50/60 Hz
Power consumption	100 V/60 Hz	110 VA
	240 V/50 Hz	120 VA
Current rating	100 V/60 Hz	1.10 A
	240 V/50 Hz	0.50 A
Fuse		T 3.15 AH, 250 V
Regulatory standards		
Protection class (I, II)		I
Electromagnetic compatibility (EMC)		EN 60601-1/IEC 60601-1 EN 60601-1-2/IEC 60601-1-2
Medical Devices Directive 93/42/EEC		Class IIb
Housing protection rating (IP code)		IP21
Protection against electric shock		Type BF applied part
Degree of protection in the presence of flammable mixtures		Device is not protected against explosions (do not operate this device in explosive atmospheres)
Maximum suction vacuum		-60 kPa
Dimensions and weights		
Weight		8.8 kg
Dimensions (W x H x D)		300 mm x 157 mm x 436 mm
Relevant application parameters		
Nominal flow range		Hysteroscopy: 800 ml/min (max. flow, not adjustable) Endourology: 10–800 ml/min (max. flow) Laparoscopy: 0.1–1.8 l/min (max. flow)
Suction power		max. 2 l/min
Starting nominal pressure range		Hysteroscopy: 15–200 mmHg Endourology: 15–90 mmHg/20–120 cmH2O Laparoscopy: 300 mmHg (not adjustable)
Pressure		0–300 mmHg
Deficit		-9,990 to +9,990 ml/0 to 99.9 l

TECHNICAL DATA

FLUID CONTROL 2225

Balancing module 2225023	
Device properties	
Operating conditions	+10°C to +40°C, 30% to 75% rel. humidity, 70 to 106 kPa atmospheric pressure 3,000 m max. altitude above sea level
Storage and transport conditions	-20°C to +60°C , 10% to 90% rel. humidity 70 to 106 kPa atmospheric pressure
Regulatory standards	
Electromagnetic compatibility (EMC)	EN 60601-1/IEC 60601-1 EN 60601-1-2/IEC 60601-1-2
Housing protection rating (IP code)	IP21
Maximum load of container scale	16 kg/4 containers of 3 l each
Maximum load of bag scale	23 kg/4 bags of 5 l each
Dimensions and weights	
Weight	15.4 kg
Dimensions (W x H x D)	618 mm x 1,064 mm x 618 mm

Footswitch 2204901	
Power supply	
Power supply connection	max. 24 V
Power consumption	max. 0.1 A
Regulatory standards	
Electromagnetic compatibility (EMC)	EN 60601-1/IEC 60601-1
Housing protection rating (IP code)	IPX8
Plug	7-pin circular connector
Cable length	4.5 m
Dimensions and weights	
Weight	300 g
Dimensions (W x H x D)	66 mm x 27 mm x 91 mm

FLUID CONTROL LAP 2216

	
Product no.	
<p>FLUID CONTROL LAP suction irrigation pump bndl consisting of: LAP suction irrigation pump (2216001) and power cable 3 m long (2440.03)</p>	22160011

Accessories		Product no.
Bracket	for fixing the suction container on the irrigator stand or MUT cart	2215.992
Universal holder	for FLUID CONTROL LAP on RIWomobil	32114605

V124 || Subject to modifications. Please note that some products may not be available in all countries. Please always take note of the information that is provided with the product. For more detailed information, please consult with your contact partner or directly with Richard Wolf GmbH.

LAP SUCTION IRRIGATION PUMP 2216

SUCTION IRRIGATION TUBE SETS

Irrigation			Product no.
Accessories – reusable	Tube set with piercing spike	with Luer-Lock connection, autoclavable, incl. 10 spare membranes, reusable for 20 reprocessing cycles	8171223
Accessories – disposable	Irrigation tube set with piercing spike, L 3 m	(PACK= 10 PCS), with Luer-Lock connection, sterile, disposable product	4171223
	Tube set with CARE-LOCK, L 3 m	(PACK= 10 PCS), sterile, disposable product	4171224
	Suction irrigation tube set	(PACK= 10 PCS), with piercing spike, sterile disposable product, PVC	4171225

Suction			Product no.
Accessories – reusable	Tube set for vacuum, incl. filter	with integrated hygiene filter, PACK= 10 PCS, service life: 30 days (connected to irrigation pump)	2206207
	Irrigation tube	L 1.2 m, with Luer-Lock, for suction irrigation handle 8385.901 and tube set 8171223 or 8170.223	817123
	Suction tube L 3 m	for suction irrigation handle 8385.901	8171402
	Secretion container, 2 l	2 liters, without cover	8170.6551
	Cover	for secretion trap 8170.6551, reusable	8170.6552
Accessories – disposable	Secretion container, 2.5 l	2.5 liters	41706566
	Secretion container bndl consisting of:	Secretion container 2.5 l (41706566) and secretion bag (PACK= 90 PCS) (41706564)	4170657
	Tube set for suction (2 connections)	sterile, disposable product, (PACK= 10 PCS) for connecting instruments to collecting container	T0503-01
	Angled 90° plug-in coupling	(PACK= 10 PCS) For connecting vacuum tube 2206207 to disposable container systems	0771019

TECHNICAL DATA

FLUID CONTROL LAP 2216

LAP suction irrigation pump		2216001
Device properties		
Operating conditions	+10°C to +40°C, 30% to 75% rel. humidity, atmospheric pressure 700 hPa to 1,060 hPa 3,000 m max. altitude above sea level	
Storage conditions	+5°C to +40°C, 5% to 90% rel. humidity, atmospheric pressure 700 hPa to 1,060 hPa	
Transport and shipping conditions	-20°C to +60°C, 5% to 90% rel. humidity, atmospheric pressure 700 hPa to 1,060 hPa	
Power supply		
Mains + frequency	100–240 V~, 50/60 Hz	
Power consumption	100 V/60 Hz	65 VA
	240 V/50 Hz	96 VA
Current rating	100 V/60 Hz	0.65 A
	240 V/50 Hz	0.42 A
Protection class	I	
Electromagnetic compatibility (EMC)	IEC 60601-1/EN 60601-1 IEC 60601-1-2/EN 60601-1-2	
Medical Devices Directive 93/42/EEC	Class IIa	
Protection against electric shock	Type BF applied part	
Degree of protection against the ingress of liquids	IP 41	
Degree of protection in the presence of flammable mixtures	Device is not protected against explosions (do not operate this device in explosive atmospheres)	
Dimensions and weights		
Weight	4 kg	
Dimensions (W x H x D) with toggle screw	140 mm x 210 mm x 295 mm	

Relevant application parameters	
Maximum delivery rate	Rinsing: 2.0 l/min (± 10%), suction: 2.0 l/min (+0.4/-0.1 l/min)
Maximum pump pressure	400 mmHg (± 50 mmHg)
Motor cut-out	500 mmHg after 5 s (± 25 mmHg)
Suction pressure	between -50 kPa and -60 kPa
Connections	Equipotential bonding, vacuum connection

HF GENERATOR 2260



core

		Product no.
HF surgical generator 400 kHz	for the connection of monopolar and bipolar accessories, international version (BOWA, KLS Martin, Olympus, Karl Storz, Valleylab)	2260001
HF surgical generator 400 kHz	for the connection of monopolar and bipolar accessories, E version (Erbe)	2260002

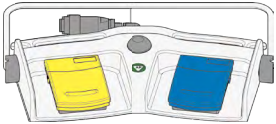
Accessories required	Cable length	Product no.
Footswitch, 2 pedals L 5 m with fixed connection cable, reusable 		2260021
Neutral electrode for use with high-frequency surgical device, Foil bag with 5 neutral electrodes, (PACK= 50 PCS)		1280H
Mono HF neutral electrode cable, L 4.5 m	4.5 m	2260031
Power cable	3.0 m	2440.03
Bipo HF connection cable L 3 m	3.0 m	8108233
Bipo HF connection cable L 5 m	5.0 m	8108253







V124 | Subject to modifications. Please note that some products may not be available in all countries. Please always take note of the information that is provided with the product. For more detailed information, please consult with your contact partner or directly with Richard Wolf GmbH.

HF GENERATOR 2260

TECHNICAL DATA

HF surgical generator 400kHz		2260001/2260002
Device properties		
Type of controls on housing front		Touch panel
Output power	max.cutting power	400 W
	max.coagulation power	350 W
LF and HF leakage currents		acc. to DIN EN 60601-1 and DIN EN 60601-2-2
Signal level		HF indicator 55 dB(A); adjustable 45–60 dB(A) Alarm 65 dB(A)
Operating conditions		+10°C to +40°C, 30% to 75% rel humidity, 700 hPa to 1,060 hPa atmospheric pressure
Storage and transport conditions		- 20°C to + 60°C, 10% to 90% rel humidity, 700 hPa to 1,060 hPa atmospheric pressure
Power supply		
Mains + frequency		100–240 V~, 50/60 Hz
Power consumption	without HF output	45 VA
	at max. output power	650 VA
Current rating		max. 6.3 A
Fuse		T 6.3 AH 250 V
Regulatory standards		
Protection class to EN/IEC 60601-1 (UL 2601-1/CSA C222 No6011 – for USA)		I
Electromagnetic compatibility (EMC)		EN/IEC 60601-1-2
Medical Devices Directive 93/42/EEC		Class IIb
Degree of protection against the ingress of liquids (DIN EN/IEC 60529)		IPX0
Degree of protection against the ingress of solids		IP2X
Duty factor (duty cycle DC)		Intermittent INT 10 s/30 s corresponding to 25% DC
Protection against electric shock		Model CF applied part, defibrillator-proof
Degree of protection in the presence of flammable mixtures		Device is not protected against explosions (do not operate this device in explosive atmospheres)
Dimensions and weights		
Weight		10.2 kg (22.4 lbs)
Dimensions (W x H x D)		300 x 159 x 419 mm

HF CONNECTION CABLE MONO 815xxx

Instrument connector	Device connector		Product no.
WOLF Resectoscopes 	 ERBE (ACC/ICC/IO)/BOWA (EU) R. Wolf HF surgical generator 400 kHz 2260002	HF connection cable mono L 3 m	815.032
		HF connection cable mono L 5 m	815.052
	 ERBE (T series)	HF connection cable mono L 3 m	815.132
		HF connection cable mono L 5 m	815.152
HF electrodes, monopolar 	 Martin (M-version)/Berchtold/ Aesculap	HF connection cable mono L 3 m	815.031
		HF connection cable mono L 5 m	815.051
	 Bovie/Valleylab/Erbe (Int.)/ BOWA (Int.) R. Wolf HF surgical generator 400 kHz 2260001	HF connection cable mono L 3 m	815.033
		HF connection cable mono L 5 m	815.053
	 BOWA (Int./EU) Eschmann and other devices with 4 mm plugs R. Wolf HF surgical generator 400 kHz 2260001	HF connection cable mono L 3 m	815.034
		HF connection cable mono L 5 m	815.054

V124 || Subject to modifications. Please note that some products may not be available in all countries. Please always take note of the information that is provided with the product. For more detailed information, please consult with your contact partner or directly with Richard Wolf GmbH.









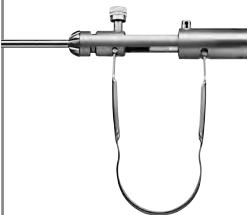

HF CONNECTION CABLE MONO 8106xxx

Instrument connector	Device connector		Product no.
WOLF Instruments/surgical generator 		HF connection cable mono L 3 m	8106.032
	Erbe (ACC/ICC/VIO)/BOWA (EU) R. Wolf HF surgical generator 400 kHz 2260002	HF connection cable mono L 5 m	8106.052
		HF connection cable mono L 3 m	8106.132
	Erbe (T series)	HF connection cable mono L 5 m	8106.152
HF electrodes, monopolar 		HF connection cable mono L 3 m	8106.031
	Martin (M-version)/Berchold/ Aesculap	HF connection cable mono L 5 m	8106.051
		HF connection cable mono L 3 m	8106.033
	Bovie/Valleylab/Erbe (Int.)/ BOWA (Int.) R. Wolf HF surgical generator 400 kHz 2260001	HF connection cable mono L 5 m	8106.053
		HF connection cable mono L 3 m	8106.034
	BOWA (Int./EU) Eschmann and other devices with 4 mm plugs R. Wolf HF surgical generator 400 kHz 2260001/2260002	HF connection cable mono L 5 m	8106.054

BIPO HF CONNECTION CABLE





8108xxx

DEVICES / ACCESSORIES

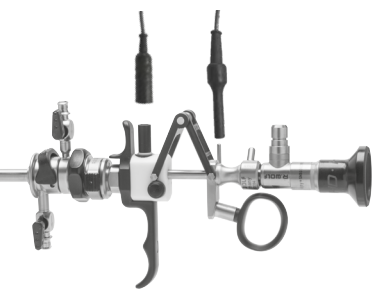

Instrument connector	Device connector		Product no.	
<p>WOLF Bipolar forceps</p> 	 <p>ERBE (ACC/ICC/T)/BOWA (EU) R. Wolf HF surgical generator 400 kHz 2260001/2260002</p>	HF connection cable bipo; L 3 m	8108.032	
		HF connection cable bipo; L 5 m	8108.052	
	 <p>International / 2-pin Valleylab R. Wolf HF surgical generator 400 kHz 2260001/2260002</p>	HF connection cable bipo; L 3 m	8108.033	
		HF connection cable bipo; L 5 m	8108.053	
	 <p>WOLF/Martin (M-version)/ Berchtold/Aesculap</p>	HF connection cable bipo; L 3 m	8108.031	
		HF connection cable bipo; L 5 m	8108.051	
	 <p>EMC Dolley</p>	HF connection cable bipo; L 3 m	8108035	
	<p>Bipolar tweezers connection</p> 	 <p>ERBE (ACC/ICC/T)/BOWA (EU) R. Wolf HF surgical generator 400 kHz 2260001/2260002</p>	HF connection cable bipo; L 3 m	8108.132
			HF connection cable bipo; L 5 m	8108.152
 <p>International / 2-pin Valleylab R. Wolf HF surgical generator 400 kHz 2260001/2260002</p>		HF connection cable bipo; L 3 m	8108.133	
		HF connection cable bipo; L 5 m	8108.153	
 <p>Martin (M-version)/Berchtold/ Aesculap</p>		HF connection cable bipo; L 3 m	8108.131	
		HF connection cable bipo; L 5 m	8108.151	
 <p>EMC Dolley</p>		HF connection cable bipo; L 3 m	8108135	

V124 || Subject to modifications. Please note that some products may not be available in all countries. Please always take note of the information that is provided with the product. For more detailed information, please consult with your contact partner or directly with Richard Wolf GmbH.

HF CONNECTION CABLE BIPO FOR RESECTION IN SALINE SOLUTION

Instrument connector	Device connector		Product no.
<p>WOLF S(a)line resectoscopes</p> 	 Erbe VIO 300D	<p>Bipolar cable; TUR/TCR; WOLF</p> <p>MF plug; L 4 m</p>	<p>20196-119</p>
	 Erbe VIO 3	<p>Bipolar cable; MF-U</p> <p>MF plug; L 4.5 m</p>	<p>21196-119</p>
	 KLS Martin	<p>HF connection cable bipo; L 3 m</p>	<p>8108.231</p>
		<p>HF connection cable bipo; L 5 m</p>	<p>8108.251</p>
	 R. Wolf HF surgical generator 400 kHz 2260001/2260002		<p>8108233</p>
		<p>HF connection cable bipo; L 5 m</p>	<p>8108253</p>

MONO HF NEUTRAL ELECTRODE CABLE

Instrument connector	Device connector		Product no.
<p>2-pole neutral electrode</p> 	 <p>R. Wolf HF surgical generator 400 kHz 2260001/2260002</p>	<p>Mono HF neutral electrode cable, L 4.5 m</p>	<p>2260031</p>

V124 || Subject to modifications. Please note that some products may not be available in all countries. Please always take note of the information that is provided with the product. For more detailed information, please consult with your contact partner or directly with Richard Wolf GmbH.

FLEXIBLE FIBER CHOLEDOCHOSCOPE 5 MM CHANNEL 2.5 MM

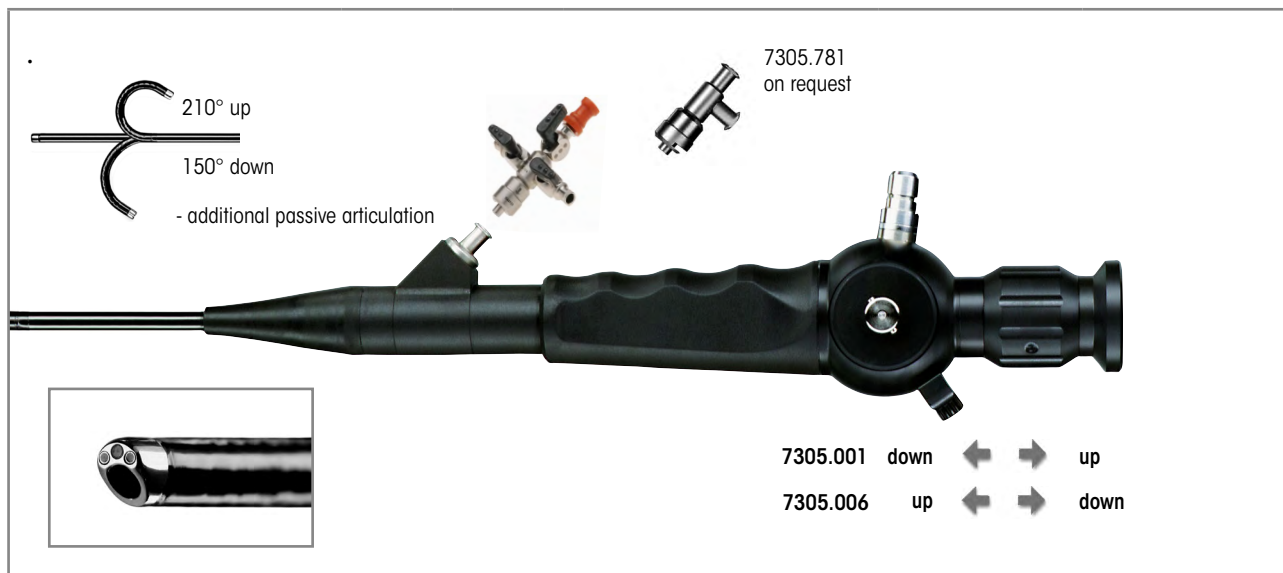

	Outer Ø	Working channel	WL	Control lever in distal direction – articulation downward	Control lever in distal direction – articulation upward	Product no.
Fiber cystoscope 15 Fr WL 400 mm Slanted distal tip Articulation +210°/-150° Direction of view 0°, viewing angle 110°	5 mm 15 Fr	25 mm 75 Fr	400 mm	•		7305.001
					•	7305.006
Fiber cystoscope bndl consisting of: Fiber cystoscope 15 Fr WL 400 mm (7305.001) Adapter with 2 irrigation valves and 1 instrument port (7305.782) Leakage tester for flex. endoscopes (163.903) Pressure equalization valve (163.904) Cleaning brush Ø 3 mm, TL 1,200 mm (PACK= 10 PCS) (7990002)				•		730500111
Fiber cystoscope bndl consisting of: Fiber cystoscope 15 Fr WL 400 mm (7305.006) Adapter with 2 irrigation valves and 1 instrument port (7305.782) Leakage tester for flex. endoscopes (163.903) Pressure equalization valve (163.904) Cleaning brush Ø 3 mm, TL 1,200 mm (PACK= 10 PCS) (7990002)					•	730500611

Recommended accessories	Product no.
Fiber light cable bndl consisting of: Fiber light cable Ø 2.5 mm TL 2.3 m (80662523), projector-side adapter (8095.07), and endoscope-side adapter (809509)	Ø 2.5 mm, 2.3 m long 806625231

mamba
VISION

FLEXIBLE SENSOR ENDOSCOPE FOR USE IN CHOLEDOCHOSCOPY

FOR ENDOCAM **Logic 4K** CONTROLLER



	Outer Ø	Working channel	WL	Control lever in distal direction – articulation downward	Control lever in distal direction – articulation upward	Product no.
Sensor cystoscope 16.2 Fr WL 400 mm Slanted distal tip Articulation +210°/-210° Direction of view 0°, viewing angle 120°	16.2 Fr	2.5 mm 7.5 Fr	400 mm	•		7315001
					•	7315006
Sensor cystoscope bndl consisting of: Sensor cystoscope 16.2 Fr, WL 400 mm (7315001) Leakage tester for flex. endoscopes (163.903), pressure equalization valve (163.904), Luer sealing cap (15023205), and cleaning brush Ø 5 mm, TL 1,200 mm (PACK= 10 PCS) (7990005)				•		73150012
Sensor cystoscope bndl consisting of: Sensor cystoscope 16.2 Fr, WL 400 mm (7315006) Leakage tester for flex. endoscopes (163.903), pressure equalization valve (163.904), Luer sealing cap (15023205), and cleaning brush Ø 5 mm, TL 1200 mm (PACK= 10 PCS) (7990005)					•	73150062
Recommended accessories						Product no.
Fiber light cable bndl consisting of: Fiber light cable Ø 2.5 mm TL 2.3 m (80662523), projector-side adapter (8095.07), and endoscope-side adapter (809509)				Ø 2.5 mm, 2.3 m long		806625231

V124 | Subject to modifications. Please note that some products may not be available in all countries. Please always take note of the information that is provided with the product. For more detailed information, please consult with your contact partner or directly with Richard Wolf GmbH.

TÜBINGER MIC TRAINING DEVICE

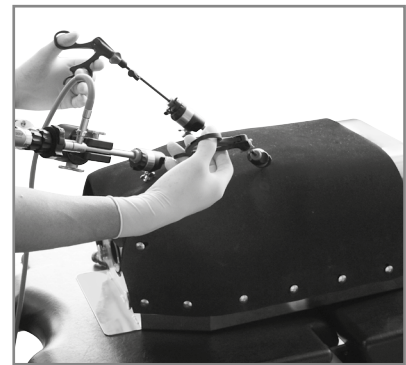
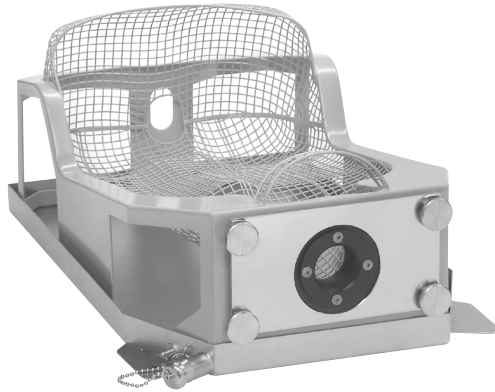

		Product no.
Tübinger MIC trainer with 3 abdominal walls (foam rubber)	(W x H x D) 560 x 350 x 230 mm	9500.056

Recommended accessories		Product no.
Abdominal wall, foam rubber, PACK= 5 PCS		9500.0561
Available on request with transportation case	